

Invacare® Typhoon II

SERVICE MANUAL



This document contains information on:

Troubleshooting

Maintenance

Repair

Version: 01.10.10

A	Mobitec Mobilitätshilfen GmbH Herzog Odilostrasse 101 A-5310 Mondsee Austria	☎: Fax: @: @: WWW:	+43 6232 55 35 0 +43 6232 55 35 4 office@mobitec-austria.com austria@invacare.com www.mobitec-austria.com
B	Invacare® n.v. Autobaan 22 B-8210 Loppem (Brugge)	☎: Fax: @: WWW:	+32 (0)50 83 10 10 +32 (0)50 83 10 11 belgium@invacare.com www.invacare.be
L	Belgium		
CH	Mobitec Rehab AG Benkenstraße 260 CH-4108 Witterswil Switzerland	☎: Fax: @: @: WWW:	+41 (0)61 48 77 08 0 +41 (0)61 48 77 08 1 office@mobitec-rehab.ch switzerland@invacare.com www.mobitec-rehab.ch
D	Invacare Aquatec Alemannenstraße 10 88316 Isny Deutschland	☎: Fax: @: WWW:	+49 (0)75 62 7 00 0 +49 (0)75 62 7 00 66 info@invacare-aquatec.com www.invacare-aquatec.de
DK	Invacare® A/S Sdr. Ringvej 37 DK-2605 Brøndby Danmark	☎ (Kundeservice): Fax (Kundeservice): @: WWW:	+45 (0)36 90 00 00 +45 (0)36 90 00 01 denmark@invacare.com www.invacare.dk
E	Invacare® SA c/ Areny, s/n Polígon Industrial de Celrà E-17460 Celrà (Girona) ESPAÑA	☎: Fax: @: WWW:	+34 (0)972 49 32 00 +34 (0)972 49 32 20 contactsp@invacare.com www.invacare.es
F	Invacare® Poirier SAS Route de St Roch F-37230 Fondettes France	☎: Fax: @: WWW:	+33 (0)247 62 64 66 +33 (0)247 42 12 24 contactfr@invacare.com www.invacare.fr
GB	Invacare® Ltd Pencoed Technology Park Pencoed Bridgend CF35 5HZ United Kingdom	☎ (Customer Service): Fax (Customer Service): @: @: WWW:	+44 (0)1656 776 222 +44 (0)1656 776 220 uk@invacare.com eire@invacare.com www.invacare.co.uk
I	Invacare Mecc San s.r.l. Via Dei Pini, 62 I - 36016 Thiene (VI) ITALIA	☎: Fax: @: WWW:	+39 0445 38 00 59 +39 0445 38 00 34 italia@invacare.com www.invacare.it
IE	Invacare Ireland Ltd. Unit 5 Seatown Business Campus Seatown Rd, Swords County Dublin Ireland	☎: Fax: @: WWW:	+353 18 10 70 84 +353 18 10 70 85 eire@invacare.com www.invacare.ie
N	Invacare® AS Grensesvingen 9 Postboks 6230 Etterstad N-0603 Oslo Norge	☎ (Kundeservice): Fax (Kundeservice): @: WWW:	+47 (0)22 57 95 00 +47 (0)22 57 95 01 norway@invacare.com www.invacare.no
NL	Invacare® B.V. Celsiusstraat 46 NL-6716 BZ Ede Nederland	☎: Fax: @: WWW:	+31 (0)318 69 57 57 +31 (0)318 69 57 58 nederland@invacare.com www.invacare.nl
P	Invacare Portugal, Lda Rua Estrada Velha, 949 P-4465-784 Leça do Balio Portugal	☎: ☎: Fax: @: WWW:	+351 225 1059 46 +351 225 1059 47 +351 225 1057 39 portugal@invacare.com www.invacare.pt



Återförsäljare:
Invacare® AB
Fagerstagatan 9
S-163 91 Spånga
Sverige



Tillverkare:
Invacare® Deutschland GmbH
Kleiststraße 49
D-32457 Porta Westfalica
Deutschland

☎ (Kundtjänst): +46 (0)8 761 70 90
Fax (Kundtjänst): +46 (0)8 761 81 08
@: sweden@invacare.com
@: finland@invacare.com
WWW: www.invacare.se

MÖLNDAL

☎: +46 (0)31 86 36 00
Fax: +46 (0)31 86 36 06
@: ginvacare@invacare.com

LANDSKRONA

☎: +46 (0)418 285 40
Fax: +46 (0)418 180 89
@: linvacare@invacare.com

OSKARSHAMN

☎: +46 (0)491 101 40
Fax: +46 (0)491 101 80
@: oinvacare@invacare.com

Table of Contents

Chapter	Page
TABLE OF CONTENTS	4
1 INTRODUCTION	6
1.1 General information	6
1.2 Notes on transport	6
1.3 Definition and representation of information and safety information in this manual	7
1.4 Hazard symbols and symbols used	8
1.5 Images in this manual	9
2 SAFETY AND FITTING INSTRUCTIONS	10
2.1 Before any inspection or repair work	10
2.2 Personal safety equipment	10
2.3 General safety information and information about fitting / removal	10
3 TIGHTENING TORQUES	12
4 LAYOUT OF MODULES, COMPONENTS AND DISPLAYS AND CONTROLS	13
5 SERVICE PLAN (1X ANNUALLY)	14
6 OPERATIONAL FAULTS	16
6.1 Operational faults on electric wheelchair with ACS	16
6.1.1 Drive fault diagnosis	16
6.1.2 Fault diagnosis with electric actuator motors	18
6.1.3 REM24 Error Codes and Diagnostic Codes	19
7 REPAIR WORK	21
7.1 Replacing and calibrating drive motor	21
7.1.1 Replacing the motor	21
7.1.2 Calibration of GB motors	29
7.2 Replacing electronic components	31
7.3 Removing and fitting batteries	33
7.4 Replacing the main fuse.	39

7.5	Checking the cables	41
7.6	Replacing the ACS Remote	42
7.7	Updating the driving program	44
7.8	Checking an actuator motor	45
7.9	Adjusting and replacing the speed reduction switch	46
7.10	Replacing the Locking-Gas Cylinder	47
7.11	Replacing the steering head bearings on the front and rear steering wheels	53
7.11.1	Front steering wheels	53
7.11.2	Rear steering wheels and	54
7.12	Replacing the safety belt	56

1 Introduction

1.1 General information

- Service and maintenance work must be carried out taking this service manual into account.
- It is imperative that you observe safety information.
- Information about operation or about general maintenance and care work on the mobility aid should be taken from the operating manual.
- You can find information about ordering spare parts in the spare parts catalogue.
- Only use original Invacare® spare parts. The guarantee will become invalid if other spare parts are used!
- We reserve the right to make any alterations on the grounds of technical improvements.
- The mobility aid may only be maintained and overhauled by qualified personnel.
- The minimum requirement for service technicians is suitable training, such as in the cycle or orthopaedic mechanics fields, or sufficiently long-term job experience.
 - Experience in the use of electrical measuring equipment (multimeters) is also a requirement.
 - Special Invacare® training is recommended.
- Alterations to the mobility aid which occur as a result of incorrectly or improperly executed maintenance or overhaul work lead to the exclusion of all liability on the side of INVACARE.
- If you have any problems or questions please contact INVACARE SERVICE.

1.2 Notes on transport

- If the mobility aid has to be shipped back to the manufacturer for major repairs, you should always use the original packaging for transport.
- Please attach a precise description of the fault.

1.3 Definition and representation of information and safety information in this manual

Different types of information and signal words are used throughout this manual.



HAZARD!

The signal word "HAZARD!" refers to immediate hazards.

- *The following lines in italics refer to actions which serve to avoid such hazards.*
-



WARNING!

The signal word "WARNING!" refers to possibly-occurring hazards which can lead to death or serious injuries if they are not avoided.

- *The following lines in italics refer to actions which serve to avoid such hazards.*
-



ATTENTION!

The signal word "ATTENTION!" refers to possibly-occurring hazards which can lead to minor injuries and/or material damage if they are not avoided.

- *The following lines in italics refer to actions which serve to avoid such hazards.*
-



CAUTION!

The signal word "CAUTION!" refers to hazards which could lead to material damage if they are not avoided.

- *The following lines in italics refer to actions which serve to avoid such hazards.*
-



Note

The signal word "Note" is used to denote general information which simplifies the handling of your product and refers to special functions.

1.4 Hazard symbols and symbols used

Different types of hazard symbols and symbols are used throughout this manual.



General hazards

This symbol warns you of general hazards!

- *Always follow the instructions to avoid injury to the user or damage to the product!*
-



BURN HAZARD!

This symbol warns you of the danger of chemical burns, for example due to the discharge of battery acids!

- *Always follow the instructions to avoid injury to the user or damage to the product!*
-



DANGER OF CRUSHING!

This symbol warns you of crushing hazards due to inattentive working with heavy components.

- *Always follow the instructions to avoid injury to the user or damage to the product!*
-



EXPLOSION HAZARD!

This symbol warns you of an explosion hazard, which can be caused by excessive tyre pressure in a pneumatic tyre.

- *Always follow the instructions to avoid injury to the user or damage to the product!*
-



Wear safety shoes

The symbol refers to the requirement for wearing safety shoes.

- *Wear standardised safety shoes during all work.*
-



Wear eye protection

This symbol refers to the requirement for wearing eye protection, for example when working with batteries.

- *Wear eye protection when this symbol is shown.*
-



Wear safety gloves

This symbol refers to the requirement for wearing safety gloves, for example when working with batteries.

- *Wear safety gloves when this symbol is shown.*
-



Note

This symbol identifies general information which is intended to simplify working with your product and which refers to special functions.



Requirements:

- This symbol identifies a list of various tools, components and items which you will need in order to carry out certain work. Please do not attempt to carry out the work if you do not have the listed tools available.
-



Always dispose used or damaged batteries correctly

The symbol refers to information for the correct disposal of used or damaged batteries.

1.5 Images in this manual

The detailed images in this manual are given digits to identify various components. Component numbers in text and operational instructions always relate to the image directly above.

2 Safety and fitting instructions

These safety instructions are intended to prevent accidents at work, and it is imperative that they are observed.

2.1 Before any inspection or repair work

- Read and observe this repair manual and the associated operating manual!
- Observe the minimum requirements for carrying out the work (see chapter entitled " General information)!

2.2 Personal safety equipment



Safety shoes

The mobility device, and some of its components, are very heavy. These parts can result in injuries to the feet if they are allowed to drop.

- *Wear standardised safety shoes during all work.*
-



Eye protection

It is possible that battery acid can be discharged when working on defective batteries or when handling batteries improperly.

- *Always wear eye protection when working on any defective or possibly defective batteries.*
-



Safety gloves

It is possible that battery acid can be discharged when working on defective batteries or when handling batteries improperly.

- *Always wear acid-proof safety gloves when working on any defective or possibly defective batteries.*
-

2.3 General safety information and information about fitting / removal



WARNING: Danger of crushing!

Various components such as the drive unit, batteries, seat etc are very heavy. This results in injury hazards to your hands!

- *Please note the high weight of some components! This applies especially to the removal of drive units, batteries and the seat.*
-



WARNING!

Injury hazard if the vehicle starts moving unintentionally during repair work!

- *Switch the power supply off (ON/OFF key)!*
 - *Engage the drive!*
 - *Before jacking up, secure the vehicle by using chocks to block the wheels.*
-



ATTENTION!

Fire and burn hazard due to electrical short-circuit!

- *The mobility device must be completely switched off before removal of voltage-carrying components! To do this, remove the batteries.*
 - *Avoid short-circuiting the contacts when carrying out measurements on voltage-carrying components!*
-



ATTENTION!

Injury hazard and danger of damage to vehicle due to improper or incomplete maintenance work!

- *Use only undamaged tools in good condition.*
 - *Some moving parts are mounted in sockets with PTFE coating (Teflon™). Never grease these sockets!*
 - *Never use "normal" nuts instead of self-locking nuts.*
 - *Always use correctly-dimensioned washers and spacers*
 - *When reassembling, always replace any cable ties which were cut during dismantling.*
 - *After completing your work / before renewed start-up of the mobility device, check all connections for tight fitting.*
 - *After completing your work / before renewed start-up of the mobility device, check all parts for correct locking.*
 - *Only operate the vehicle with the approved tyre pressures (see technical data).*
 - *Check all electrical components for correct function. Please note that incorrect polarity can result in damage to the electronics.*
 - *Always carry out a trial run at the end of your work.*
-

**Note**

Mark all current settings for the mobility aid (seat, armrests, backrest etc.), and the associated cable connecting plugs, before dismantling. This makes reassembly easier.

All plugs are fitted with mechanical safety devices which prevent release of the connecting plugs during operation. To release the connecting plugs the safety devices must be pressed in. When reassembling ensure that these safety devices are correctly engaged.

**CAUTION!**

Any changes to the drive program can affect the driving characteristics and the tipping stability of the vehicle!

- *Changes to the drive program may only be carried out by trained Invacare® specialist dealers!*
 - *Invacare® supplies all mobility aids with a standard drive program ex-works. Invacare® can only give a warranty for safe vehicle driving behaviour - especially tipping stability - for this standard drive program!*
-

3 Tightening torques

The tightening torques stated in the following list are based on the thread diameter for the nuts and bolts for which no specific values have been determined. All values assume dry and de-greased threads.

Thread	M4	M5	M6	M8	M10	M12	M14	M16
Tightening torque in Nm $\pm 10\%$	3 Nm	6 Nm	10 Nm	25 Nm	49 Nm	80 Nm	120 Nm	180 Nm



CAUTION!

Damage can be caused to the mobility device due to improperly tightened screws, nuts or plastic connections.

- *Always tighten screws, nuts etc to the stated tightening torque.*
 - *Only tighten screws or nuts which are not listed here fingertight.*
-

4 Layout of modules, components and displays and controls

The following figure shows the Typhoon II from behind with extended seat lifter and the rear panelling removed.

- 1 Seat lean adjustment
- 2 Seat frames / rear panelling anti-collision switch
- 3 Speed controller
- 4 Main module (power module)
- 5 Lighting/actuator module

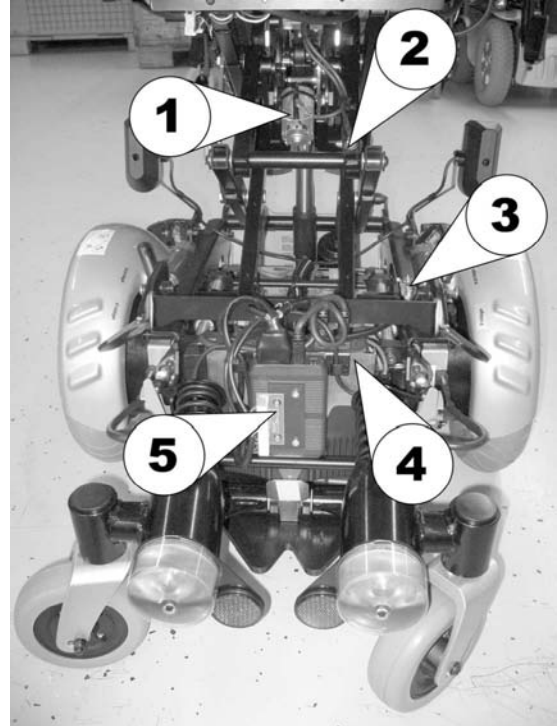

The following figure shows the Typhoon II from front right with raised lifter.

- 1 Lifter servo motor

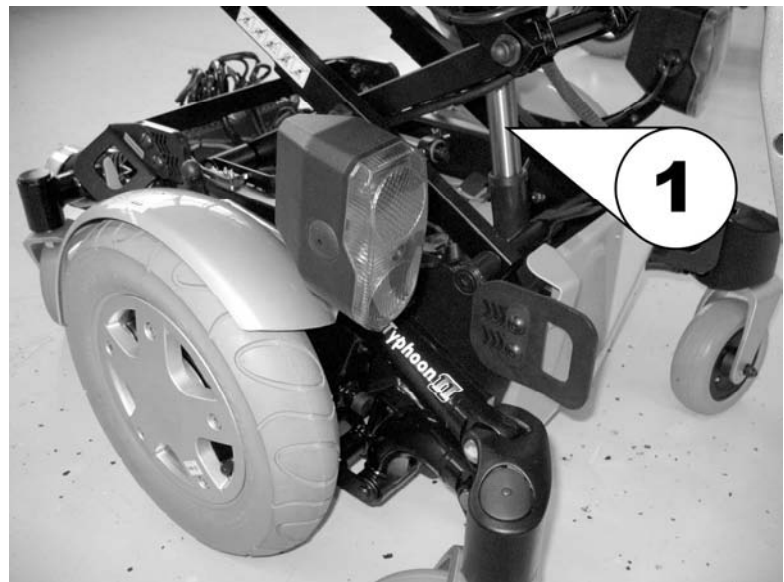

5 Service plan (1x annually)

Component	Check	Remedy	Note	✓
Armrests and side panels	<ul style="list-style-type: none"> • Armrest damage and fastening • Side panel damage and fixing 	⇒ Tighten screws, replace top surface if damaged ⇒ Tighten screws, replace side panels if damaged		
Seat unit / adjustable seat inclination	<ul style="list-style-type: none"> • Top surface • Check adjustable seat inclination 	⇒ Replace cover / upholstery if damaged. ⇒ Replace parts if damaged.		
Mechanical backrest Electrical backrest	<ul style="list-style-type: none"> • Damage and seams • Fixing • Check cable • Check function 	⇒ Replace parts if damaged. ⇒ Tighten screws ⇒ Replace cable or motor if necessary		
Frame (chassis) / battery mounting	<ul style="list-style-type: none"> • Check fixings, welded seams and battery mounting 	⇒ Tighten screws, replace components		
Locking-Gas Cylinder	<ul style="list-style-type: none"> • Check the locking-gas cylinder 	⇒ Repair or replace if damaged ⇒ Replace the locking-gas cylinder every 2 years!	See "Replacing the Locking-Gas Cylinder" on page 47	
	<ul style="list-style-type: none"> • Check adjustment 	⇒ Adjust it	See "Replacing the Locking-Gas Cylinder" on page 47	
Wheel suspension and wheels	<ul style="list-style-type: none"> • Check drive wheels for tight fit and side play 	⇒ Adjust, replace wheel hubs	See "Replacing and calibrating drive motor" on page 21	
	<ul style="list-style-type: none"> • Check steering wheels for tight fit, float, side play and correct torque (15 Nm +/- 1.5 Nm) 	⇒ Replace wheels, wheel fork or wheel bearings	See "Replacing the steering head bearings on the front and rear steering wheels" on page 53	
	<ul style="list-style-type: none"> • Check drive wheel pneumatic tyres 	⇒ Repair or replace if damaged	see operating manual	
Drive units, clutch mechanism	<ul style="list-style-type: none"> • Check functions in drive and push modes • Check clutch mechanism 	⇒ Replace motor if necessary ⇒ Tighten screws / nuts, adjust or replace if necessary		
Legrests	<ul style="list-style-type: none"> • Check welded seams, interlocking, screws, footplates 	⇒ Tighten, remove if necessary		
Electrical legrests	<ul style="list-style-type: none"> • Check cable • Check contacts • check functions 	⇒ Replace cable if necessary		
Lighting	<ul style="list-style-type: none"> • Check cable • Check function 	⇒ Replace bulbs or cable if necessary		

Component	Check	Remedy	Note	✓
Batteries	<ul style="list-style-type: none"> • Check batteries for damage 	⇒ Replace batteries if necessary	See " Removing and fitting batteries " on page 33	
	<ul style="list-style-type: none"> • Check battery voltage 	⇒ charge batteries	See operating manual	
	<ul style="list-style-type: none"> • Check contacts and terminals 	⇒ Clean contacts and terminals	See " Removing and fitting batteries " on page 33 for safety information on handling batteries	
Remote / drive electronics	<ul style="list-style-type: none"> • Remote, status display blinking • Fixing • Cable, connecting plug • Joystick function • Power supply 	⇒ Evaluate blinking code ⇒ Tighten, replace ⇒ Replace ⇒ Replace joystick ⇒ Replace cable, connecting plug or console		
Lifter module	<ul style="list-style-type: none"> • Check for correct functioning • Check locking device function. 	⇒ Repair if necessary.		
Drive program	<ul style="list-style-type: none"> • Check drive electronics program version Newer version available? 	<ul style="list-style-type: none"> • Update software 	See " Updating the driving program " on page 44	

6 Operational faults

6.1 Operational faults on electric wheelchair with ACS

If you have problems with the wheelchair, please proceed as follows:

- First assess the possible cause of the problem using the following table.
- Check the status display on the remote. Evaluate the blink error code.
- Carry out the necessary checks and repairs as recommended in the following table.



NOTE:

You can find more information about operational faults on electric wheelchairs with GB motors in the document entitled "Dynamic DX-GB-AS Power Module - Assembly Instructions", order no. 1441533

6.1.1 Drive fault diagnosis

PROBLEM	OTHER SYMPTOMS	POSSIBLE CAUSE	SOLUTION	Documentation
Wheelchair will not start	Remote status display illuminates normally without showing an error code	Drive motors possibly disengaged	<ul style="list-style-type: none"> • Re-engage drive motors 	See operating manual
	Remote status display does not illuminate	Batteries possibly defective	<ul style="list-style-type: none"> • Replace batteries 	See " Removing and fitting batteries " on page 33
		Batteries possibly over-discharged	<ul style="list-style-type: none"> • Pre-charge batteries 	See operating manual
		Power supply to remote possibly interrupted	<ul style="list-style-type: none"> • Check master fuse 	See " Replacing the main fuse " on page 39
			<ul style="list-style-type: none"> • Check cable between modules for loose connections or damage 	See " Checking the cables " on page 41
	Remote possibly defective	<ul style="list-style-type: none"> • Replace the remote on the wheelchair in order to rule out the possibility that the remote is causing the fault. 	See " Replacing the ACS Remote " on page 42	
Remote status display blinking	Various causes	<ul style="list-style-type: none"> • Assess error code 	See " REM24 Error Codes and Diagnostic Codes " on page 19	

PROBLEM	OTHER SYMPTOMS	POSSIBLE CAUSE	SOLUTION	Documentation
	Status display on remote blinking 2x, drive display on "U"	Speed controller on lifter possibly defective or not connected	<ul style="list-style-type: none"> Replace cable or switch 	See " Adjusting and replacing the speed reduction switch " on page 46
Wheelchair judders in drive mode	None	Batteries possibly defective (voltage unstable)	<ul style="list-style-type: none"> Replace batteries 	See " Removing and fitting batteries " on page 33
		Drive motor(s) possibly defective	<ul style="list-style-type: none"> Replace motor(s) 	See " Replacing and calibrating drive motor " on page 21
Batteries not being charged	None	Batteries possibly defective	<ul style="list-style-type: none"> Replace batteries 	See " Removing and fitting batteries " on page 33
	LEDs blinking on charging unit	Charging device possibly defective	<ul style="list-style-type: none"> Replace charging unit 	See charging unit operating manual
Wheelchair runs too slowly	Status display on remote blinking 2x, drive display on "U"	Seat lifter is not in drive position (either too high or too low) and has activated automatic speed regulation.	<ul style="list-style-type: none"> Run the seat lifter to the drive position 	See operating manual
		Speed controller on seat lifter may be badly adjusted.	<ul style="list-style-type: none"> Adjust regulator 	See " Adjusting and replacing the speed reduction switch " on page 46
	None	Remote possibly defective	<ul style="list-style-type: none"> Replace remote 	See " Replacing the ACS Remote " on page 42
		Batteries possibly defective	<ul style="list-style-type: none"> Replace batteries 	See " Removing and fitting batteries " on page 33

6.1.2 Fault diagnosis with electric actuator motors

Please use the following table to assess fault causes when using electric actuator motors.

PROBLEM	OTHER SYMPTOMS	POSSIBLE CAUSE	SOLUTION	Documentation
Electric actuator motor does not react	Remote shows blinking "E", status diode on lighting/actuator module does not go out even if the remote is switched off or disconnected.	Lighting / actuator module defective	<ul style="list-style-type: none"> Replace lighting/actuator module 	See " Replacing electronic components " on page 31
	None	Cable possibly disconnected or damaged	<ul style="list-style-type: none"> Check to ensure that the cable has not been disconnected or damaged. Replace cable if necessary 	See " Checking the cables " on page 41
		Electrical actuator motor possibly defective	<ul style="list-style-type: none"> Test actuator motor 	See " Checking an actuator motor " on page 45
		Remote possibly defective	<ul style="list-style-type: none"> Replace the remote on the wheelchair in order to rule out the possibility that the remote is causing the fault. 	See " Replacing the ACS Remote " on page 42

6.1.3 REM24 Error Codes and Diagnostic Codes

The drive electronics are capable of rectifying some errors automatically. In this case the status display will cease to flash. Please switch the remote on and off several times. Wait approx. 5 seconds each time before switching the remote on again. If this does not rectify the error, locate the error using the flash codes shown below.

Flash code:	Meaning:	Solution:	Notes
1 x flash	Module defective	<ul style="list-style-type: none"> Replace defective module 	See " Replacing electronic components " on page 31
2 x flashes	Accessory error (e.g. actuator short-circuit)	<ul style="list-style-type: none"> Check accessory connections, check accessories 	See " Checking an actuator motor " on page 45
	Lifter raised or lowered too far (seat not at driving height)	<ul style="list-style-type: none"> If lifter is raised, lower in stages until the status display stops flashing. If lowered too far, raise lifter in stages until the status display stops flashing. If at all possible, only drive when the seat is at driving height. 	See User Manual
3 x flashes	Connection on the left motor loose/defective	<ul style="list-style-type: none"> Check plug-in connections. 	See " Checking the cables " on page 41
	Left motor defective.	<ul style="list-style-type: none"> Check/replace motor 	See " Replacing and calibrating drive motor " on page 21
4 x flashes	Connection on the right motor loose/defective	<ul style="list-style-type: none"> Check plug-in connections. 	See " Checking the cables " on page 41
	Right motor defective.	<ul style="list-style-type: none"> Check/replace motor 	See " Replacing and calibrating drive motor " on page 21
5 x flashes	Fault/brake fault on left-hand motor. Connection loose/defective or motor defective.	<ul style="list-style-type: none"> Check plug-in connections. 	See " Checking the cables " on page 41
	Left motor disengaged (GB-motors)	<ul style="list-style-type: none"> Engage motor. Shut electronics down and then switch on again. 	See User Manual
	Both motors disengaged (standard motors)	<ul style="list-style-type: none"> Engage motors. Shut electronics down and then switch on again. 	See User Manual
6 x flashes	Fault/brake fault on right-hand motor. Connection loose/defective or motor defective.	<ul style="list-style-type: none"> Check plug-in connections. 	See " Checking the cables " on page 41
	Right motor disengaged (GB-motors)	<ul style="list-style-type: none"> Engage motor. Shut electronics down and then switch on again. 	See User Manual
7 x flashes	Battery dead	<ul style="list-style-type: none"> Pre-charge battery 	See User Manual
8 x flashes	Battery voltage too high	<ul style="list-style-type: none"> Switch lights on to lower battery voltage Check battery charger 	See User Manual of battery charger

Flash code:	Meaning:	Solution:	Notes
9 or 10 x flashes	Faulty data transmission between modules	<ul style="list-style-type: none"> - 	Remove all electronic modules except the Power Module and the Remote. Re-attach modules one by one to determine which one is causing the fault. See " Replacing electronic components " on page 31
11 x flashes	Motors overloaded / overheated	<ul style="list-style-type: none"> Switch remote on and off / wait if necessary 	-
12 x flashes	Module used has compatibility problems	<ul style="list-style-type: none"> Remove incorrect module 	See " Replacing electronic components " on page 31

7 Repair Work

7.1 Replacing and calibrating drive motor

The following two sections describe how a GB motor is replaced and a new motor is calibrated. We recommend that you read these instructions completely through before commencing work.



Note

The course of action during disassembly is different depending on whether the vehicle is fitted with puncture-proof tyres or standard pneumatic tyres! You can recognise puncture-proof tyres by the fact that they do not have a valve!

- *First find out whether the vehicle is fitted with puncture-proof tyres or pneumatic tyres!*

7.1.1 Replacing the motor



WARNING: Danger of crushing!

The mobility device is very heavy. Injury hazard to hands and feet!

- *You should seek help from a second person.*

Injury hazard caused by uncontrolled movement of the mobility device!

- *Switch the power supply off (ON/OFF key).*
- *Engage the drive.*
- *Before raising the vehicle, secure the wheels by blocking them with wedges.*



ATTENTION: Explosion hazard!

If the wheelchair is fitted with pneumatic tyres, the wheel can explode if the air is not released from the tyre before removing the wheel!

- *Always release the air from the wheel before you remove it. Depress the small tappet in the centre of the valve!*



CAUTION!

Material damage hazard. The valve can become blocked by the puncture protection gel and be unusable!

- *During the following work you should always hold the valve up so that the puncture protection gel cannot enter the valve.*



WARNING: Injury hazard!

The wheelchair will drive in an uncontrolled manner if the GB motors are not calibrated after being fitted new!

- *Ensure that the GB motors have been calibrated after being fitted!*



WARNING: Injury hazard!

If the bolts which secure the wheel are not tightened firmly enough, or if the threaded holes in the casing are damaged by being tightened too much, the wheel can come loose during travel!

- *Always position the nuts manually in their holes when fitting the drive wheels.*
- *Never use electrical or pneumatic screwdrivers !*
- *Tighten the Allen screws with a torque of 25 Nm !*
- *The Nordlock washers must be fitted exactly as they were before removal !*

**Note**

If motors become defective within their guarantee period, they will either be replaced or repaired on Invacare's decision. This guarantee does not cover pay for working hours. We also accept no liability for physical injuries or unauthorised repairs. Invacare's sole obligation and its exclusive remedy during this guarantee is limited to such repair and/or replacement measures.

**Requirements:**

- wooden block to support vehicle
- Allen key 4 mm
- Allen key 5 mm
- Allen key 6mm
- Allen key 10 mm
- circlip pliers
- jaw spanner 10 mm
- Torque wrench

Additional requirements for fitting puncture-proof tyres

- tyre fitting paste (soap-based)
- 3 bolts M8 x 30mm (for provisional positioning of wheel rim during fitting)

**Note**

Take note of small parts and the sequence in which components have been fitted. Arrange these in a tidy sequence so that they are easier to refit in the correct sequence.

- Loosen the fixing bolts (1) on the dirt arrester using the 4 mm open-ended spanner and remove them.

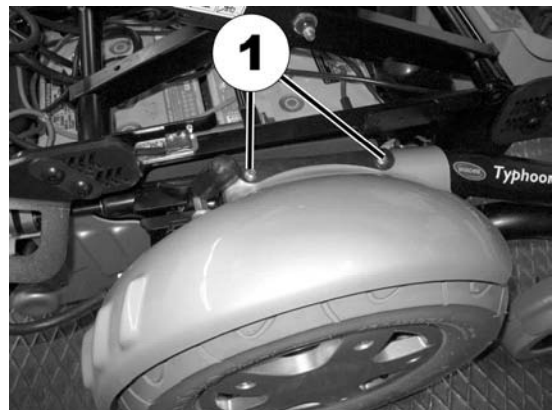

- Support the wheelchair with wooden blocks.



- Loosen the bolt (1) and disconnect the motor cable plug.

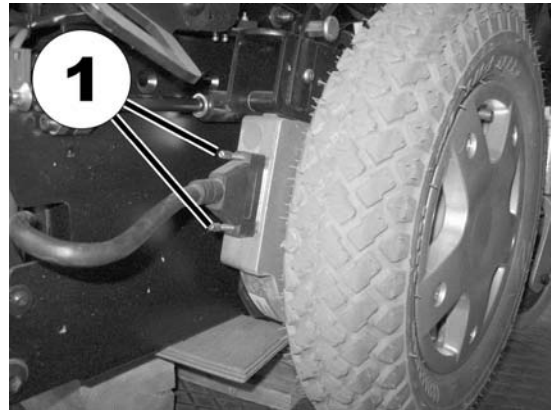

7.1.1.1 Removing wheel rim and tyres on vehicle with pneumatic tyres



EXPLOSION HAZARD!

If the wheelchair is fitted with pneumatic tyres, the wheel can explode if the air is not released from the tyre before removing the wheel !

- *Always release the air from the wheel before it is removed (depress the small tappet in the centre of the valve) !*

- Unscrew valve cap.
- Reduce the air pressure in the tyre by depressing the valve tappet (1).
- Loosen the five bolts (2) using the 6 mm Allen key.
- Remove the wheel rim halves and the inner tube from the wheel.

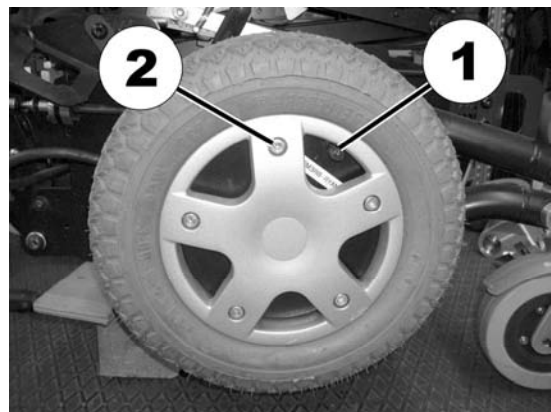

7.1.1.2 Removing wheel rim and tyres on vehicle with puncture-proof tyres



CAUTION!

Danger of damage to motor if the bolts are not loosened and removed in the prescribed sequence!

- *Only ever loosen and remove the bolts in the prescribed sequence!*

Bolts 1 to 5 must be loosened and removed in a prescribed sequence. The numbering of the bolts is not fixed, in other words there is no particular bolt permanently numbered "1". What is really meant is that the operation can start with any bolt. This is then "number 1". "Number 2" is then the next bolt in a clockwise direction, "3" the next one and so on.

- Loosen and remove bolts 1 and 3 using the 6 mm Allen key.
- Now unscrew bolts 2, 4 and 5 by one turn in a clockwise direction one after the other until all are loosened and removed.
- Remove the wheel rim halves, the tyre and the puncture-proof inner tube from the wheel.



7.1.1.3 Continuing dismantling the motor

- Open the circlip (1) securing the top bolt using the circlip pliers and remove it.

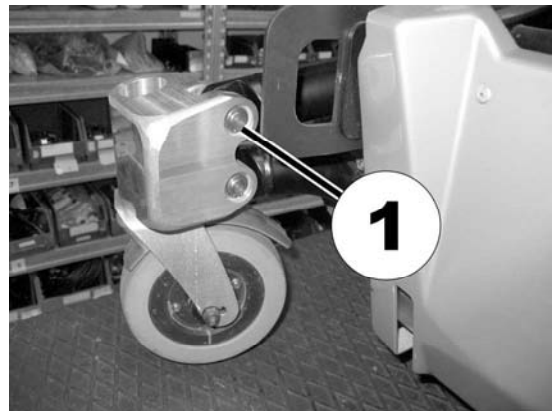

Loosen and remove the bolt (1) using the 5 mm Allen key, then loosen bolt (2).

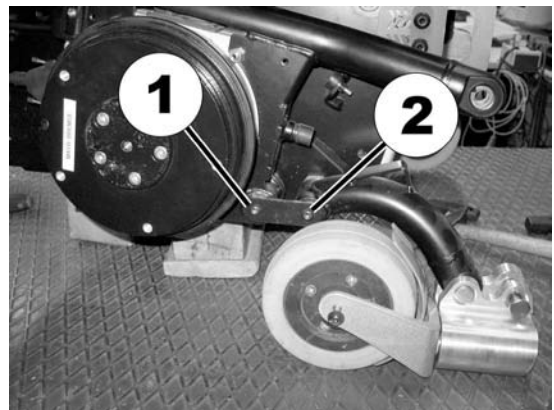

- Loosen and remove the rubber pad (1) using the pliers and the 10 mm open-ended spanner.

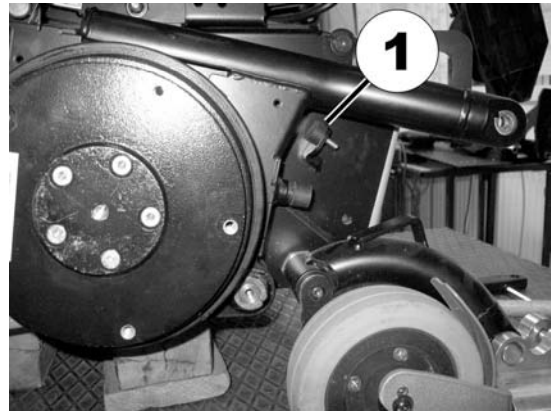

- Loosen and remove the retaining bolts (1) on the anti-dive mechanism bearing shell with the 5 mm Allen key.

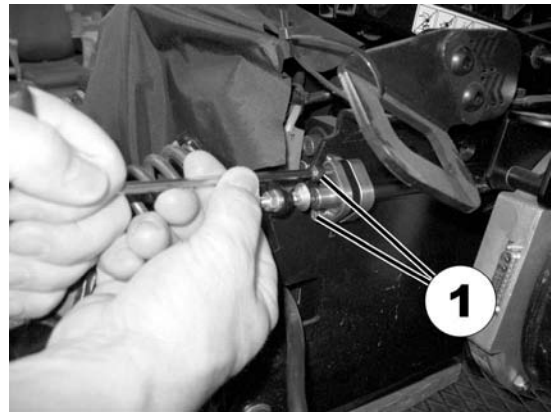

- Pull the drive unit down from the main bearing bolts.



- Loosen and remove the motor fixing bolts.
- Replace motor.

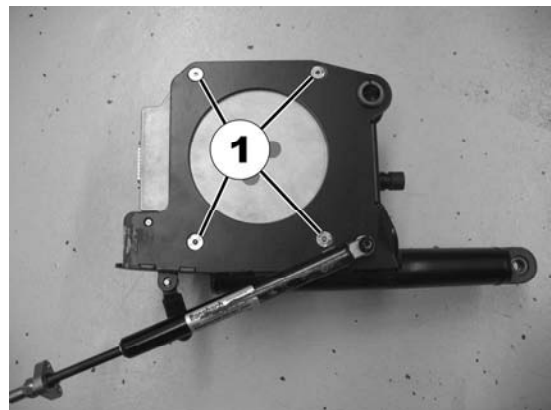



CAUTION!

There is a danger that the anti-tip mechanism will not function correctly after replacing the motor or the gas pressure spring due to a change in distance between the triggering pin on the gas pressure spring and the counter bolt.

- Check that the anti-tip mechanism is functioning correctly after replacing a motor, and readjust it if necessary.
-

- The drive unit is refitted in reverse order.
- Tighten the wheel bolts to 25 Nm.

7.1.1.4 Reassembling wheel rim and tyres on vehicle with pneumatic tyres



CAUTION!

Material damage hazard.

- In the next step **DO NOT USE thread-locking fluid!**
-

- Replace the inner tube in the tyre.
- Insert the wheel rim halves once again.
- Insert the countersunk screws with Nord-Lock washers and tighten slightly. **DO NOT USE screw locking!**
- Pump a little air into the inner tube.
- Screw the wheel rims tightly together.
- Ensure that the tyre outer is seated correctly.
- Pump the tyres up to 3 bar air pressure.
- Check that the tyre is seated correctly once again.
- Screw the valve cap back on.

7.1.1.5 Reassembling wheel rim and tyres on vehicle with puncture-proof tyres

- In order to refit tyres with puncture-proof inner tubes, the inside and outside edges of the tyre (1 and 3) and the inside surface of the core (2) must be coated with tyre fitting paste (soft soap).



- Push the tyres with puncture-proof cores onto the motor (on the rotor housing).



- Position the wheel rim halves in the tyres. The holes for the bolts in the wheel rim halves and those in the rotor housing must be aligned. While doing so, it can be helpful to use the notches in the wheel rim halves and in the rotor housing for the nonexistent valves as a positioning aid and to align them.
- Screw in three M8 x 30mm bolts by hand in positions 1, 3 and 5.
- Tighten bolts 1, 3 and 5 successively in a clockwise direction by **one rotation** each until a torque of around eight Nm is reached (check with torque wrench if necessary). **This is necessary to ensure that the wheel rim is evenly tightened onto the rotor housing.**

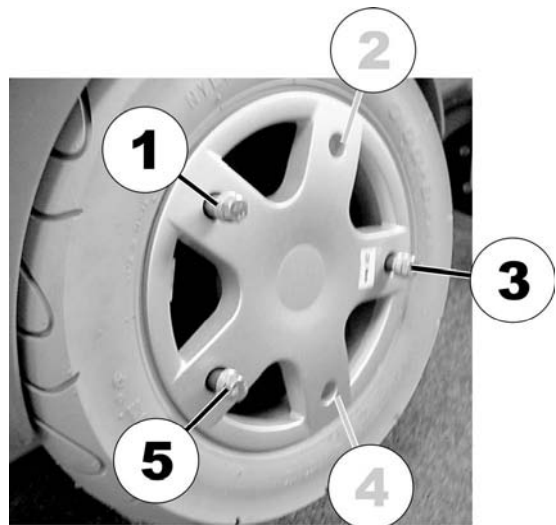

CAUTION!
Material damage hazard.

- *In the next steps DO NOT USE thread-locking fluid!*

- Screw two of the original M8 x 25 mm bolts with Nord-Lock washers at positions 2 and 4 in and tighten to fingertight (max. 8 Nm).

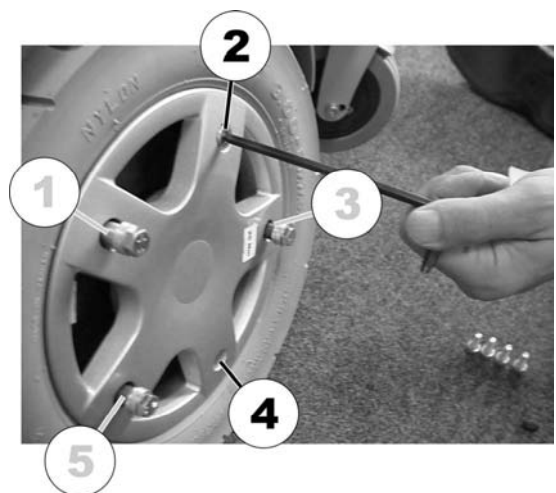

- Unscrew M8 x 30 mm prestressing bolt at **Position 5**: screw in M8 x 25 mm original bolt with Nord-Lock washers and tighten to fingertight (max. 8 Nm).
- Unscrew M8 x 30 mm prestressing bolt at **Position 1**: screw in M8 x 25 mm original bolt with Nord-Lock washers and tighten to fingertight (max. 8 Nm).
- Unscrew M8 x 30 mm prestressing bolt at **Position 3**: screw in M8 x 25 mm original bolt with Nord-Lock washers and tighten to fingertight (max. 8 Nm).
- The last thing to do is to tighten all bolts to 25 Nm.

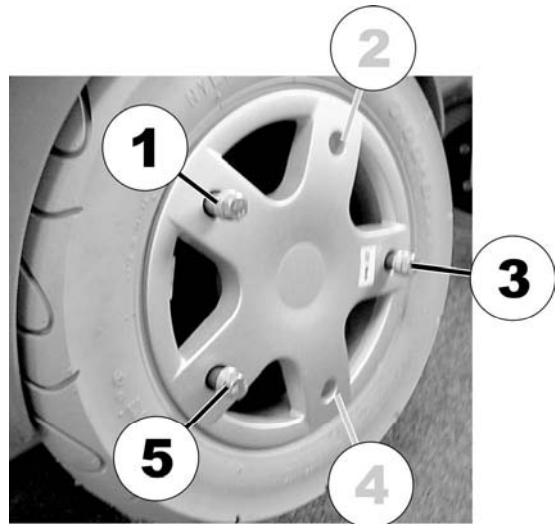

7.1.2 Calibration of GB motors

Below we describe calibration using the hand programming device.



WARNING: Risk of accidents!

Hazards to workers, surroundings and mobility device!

- Do not leave the mobility device unattended during the following procedure!
- Make sure that BOTH drive wheels are off the ground before calibrating.
- Secure the area.



Required parts/tools:

- dynamic DX HHP" hand programming device
- Support the wheelchair with wooden blocks. The drive wheels must not be touching the floor or the work surface.
- Connect the programming device. The programming device displays:

The programming device displays:	Necessary input:
DX HHP V1.20 Select language ... GB D NL S	"GB"
View system or edit? YES ? DIAG TECH	"TECH"
Technician mode Enter password 000 EXIT D1 D2 D3	Enter code "592" with keys D1 to D3, then select "EXIT".
Technician mode Master JS module JOYSTICK CALIBRATION EXIT YES NEXT	"NEXT"
** MAIN MENU ** View GB power module or edit? NEXT YES	"YES"
GB inspection Torque XX % EXIT NEXT DOWN UP	"NEXT"
GB inspection Vibration damping XX % EXIT NEXT DOWN UP	"NEXT"
GB inspection Speed sequence XX % EXIT NEXT DOWN UP	"NEXT"
GB inspection Turn sequence XX % EXIT NEXT DOWN UP	"NEXT"

The programming device displays:	Necessary input:
GB inspection Calibrate motors? EXIT NEXT YES	"YES"
GB MOTOR CALIBRATION Wheels will move! Drive wheels raised? EXIT YES	"YES" (if drive wheels raised)
GB MOTOR CALIBRATION Wheelchair will drive! Wheels raised? EXIT YES	"YES" (if drive wheels raised)
GB MOTOR CALIBRATION -BEGIN- to start. Wheels will turn! EXIT BEGIN	"BEGIN" (if drive wheels raised)
GB MOTOR CALIBRATION taking place Please wait.	No entry necessary. Wait till end of calibration.
GB MOTOR CALIBRATION Successful! EXIT	"EXIT"

- Disconnect the programming device from the wheelchair. Calibration is complete.

7.2 Replacing electronic components



Required parts/tools:

- Phillips screwdriver

- Remove enclosure (1).



- Remove all electrical connections (1) from the electronic modules.

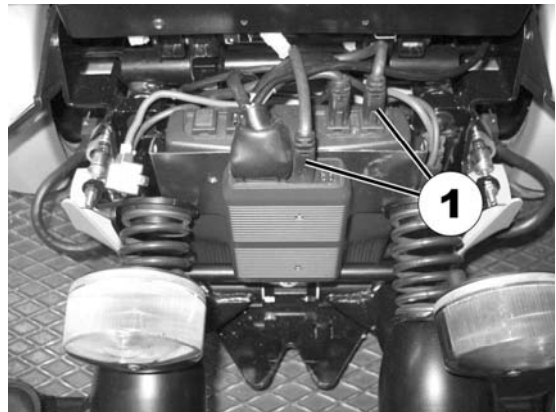

- The CLAM can be simply pulled vertically out of its holder.

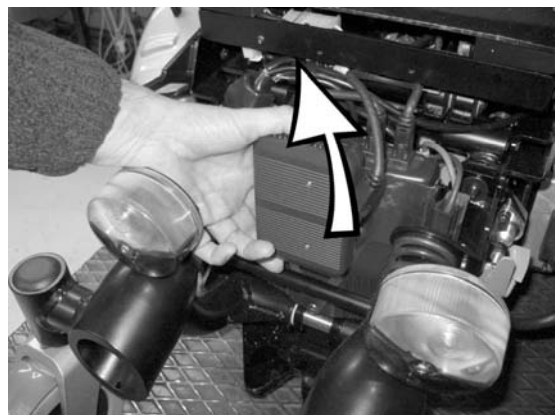

- If the power module is to be replaced, this can also be pulled upwards including its retaining frame.

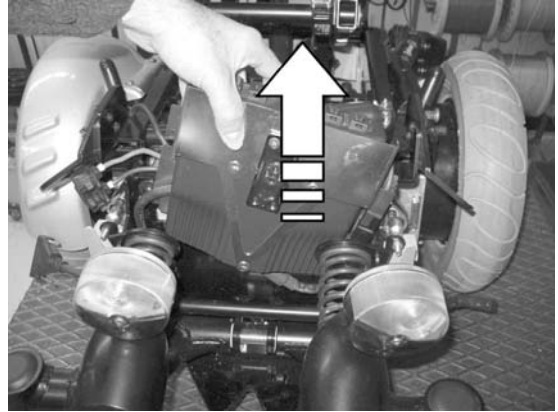

- Loosen and remove the three retaining bolts (1) on the power module.

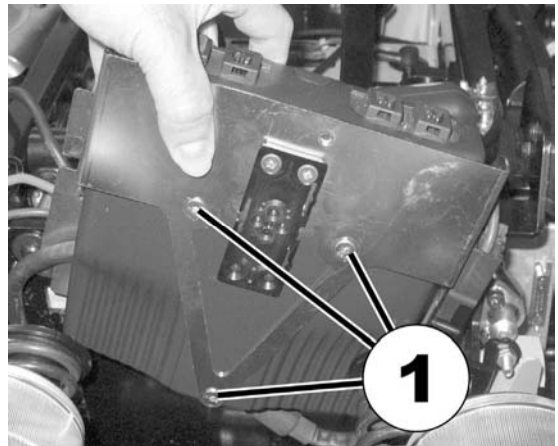

7.3 Removing and fitting batteries



ATTENTION:

Injury hazard and possible material damages if batteries are handled improperly!

- *The installation of new batteries may only be carried out by authorised specialists.*
 - *Observe the warning information on the batteries.*
 - *Only use battery versions stated in the specifications.*
-



ATTENTION:

Fire and burns hazard if battery terminal is bypassed!

- *Please take great care to ensure that the battery terminals are never short-circuited with tools or mechanical mobility device parts!*
 - *Ensure that the battery terminal caps have been replaced if you are not working on the battery terminals.*
-



ATTENTION: Danger of crushing!

The batteries are extremely heavy. This results in injury hazards to your hands.

- *Bear in mind that the batteries are sometimes very heavy!*
 - *Please handle the batteries with care.*
-



WARNING: BURN HAZARD!

Injury hazard due to discharged acid.

- *Always wear acid-proof protective gloves when handling batteries.*
- *Always wear protective goggles when handling batteries.*



What to do if acid is discharged:

- *Always take clothing which has been soiled by or dipped in acid off immediately!*
- *Rinse any areas of your skin which has come into contact with battery acid off immediately with plenty of water!*



If contact with eyes is made:

- *Rinse the affected eye under running water for several minutes! You should also consult an eye specialist immediately afterwards!*
-



Always dispose of used or damaged batteries correctly

Used and damaged batteries will be taken back by your medical equipment supplier or Invacare®.



Requirements:

- jaw spanner 11 mm
 - Allen key 8 mm
 - spare battery(s)
-



Note

A second person is required to help when carrying out this work!

- Run the seat lifter into the top position.
- Remove legrests.



- Pull actuator bolt locking out of belt.

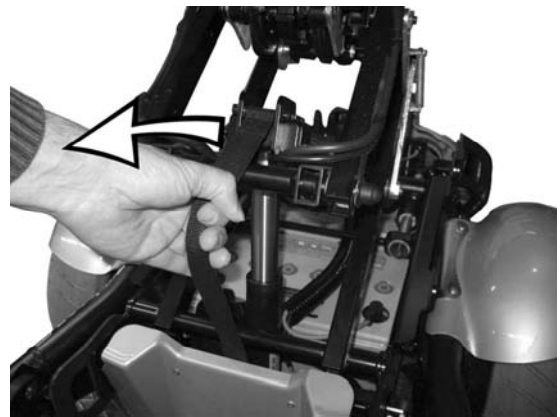

- One person lifts the seat upwards, a second person ensures that the actuator bolt head (1) is guided out of the holder and does not jam.

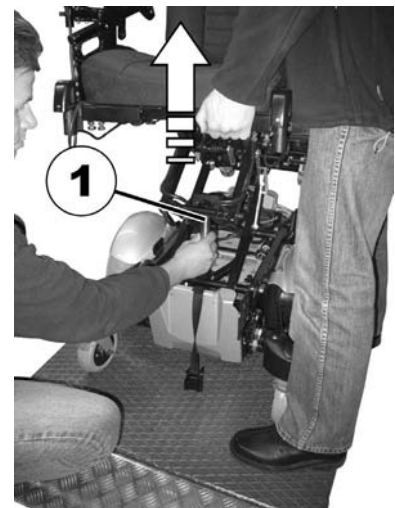

- Push the holding mechanism (1) completely to the front so that it engages.
- Run the actuator bolt completely down again.

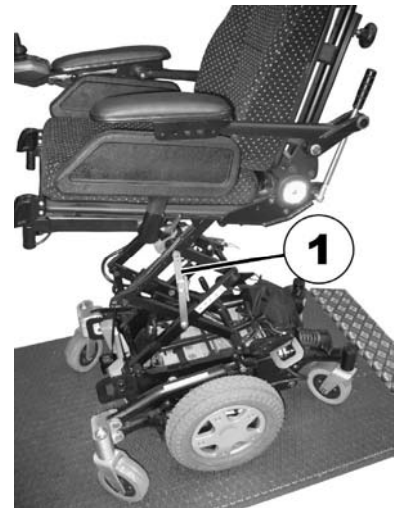

- Pull the enclosure forwards.

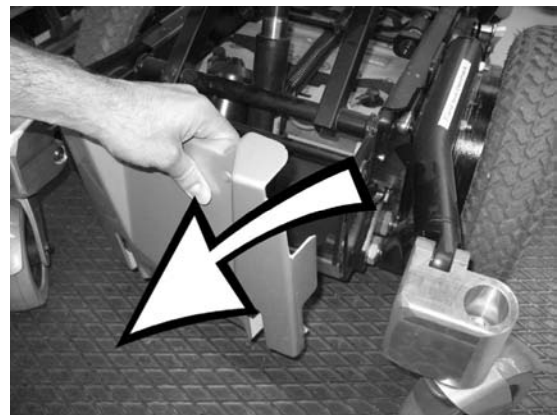

- Loosen the screws (1) on both sides with the 8 mm Allen key and remove them.

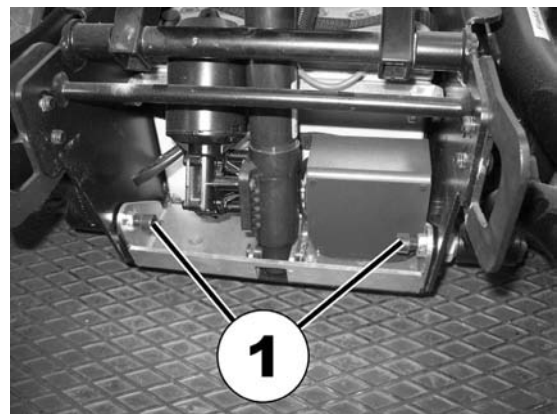

- Push the bottom actuator holder inwards together with the regulator motor...

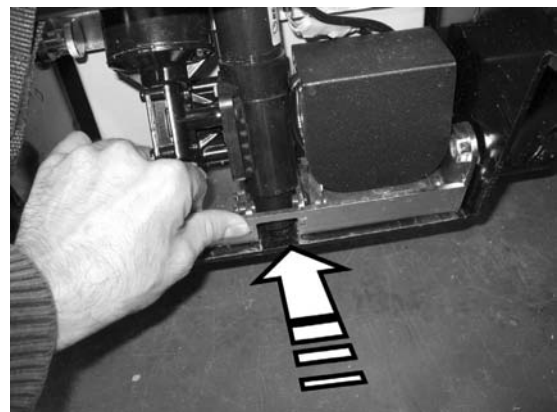

- ... then lift it (1) and pull completely out the front (2). When doing so, it helps if you put one hand under the chassis to guide the actuator holder locking pin into the position from which it can be pulled out upwards.
- Remove all the actuator connecting plugs, and place the actuator holder and all its components to the side.

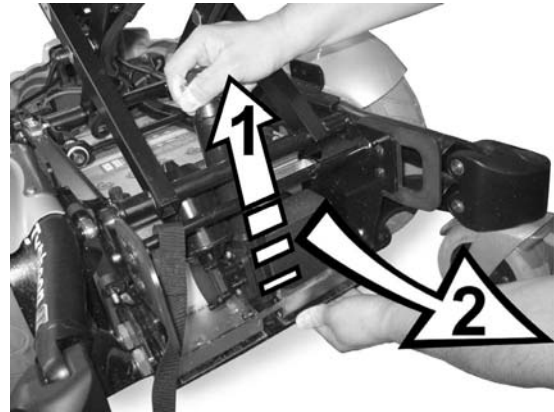

- Loosen the locking device (1) on the battery locking bar and remove the bar.

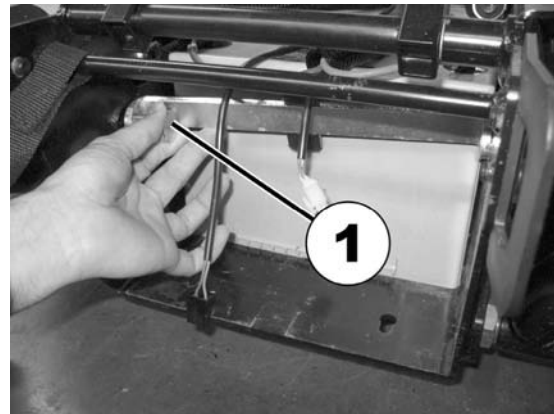

- Remove the terminal covers from the battery terminals (1).
- First, loosen the bolts on the negative terminals (black cable) with the 11 mm jaw spanner.
- After this, loosen the bolts on the positive terminals (red cable).

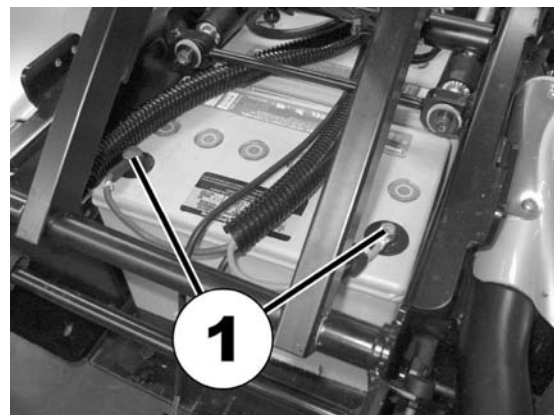

ATTENTION: Danger of crushing!

The batteries are extremely heavy. This results in injury hazards to your hands.

- *Bear in mind that the batteries are sometimes very heavy!*
- *Please handle the batteries with care.*

- Pull the batteries out to the front.





CAUTION! Fire hazard!

Cables can get jammed and frayed.

- *Ensure the cables have the correct polarity! They must not protrude into the lifter area. Use cable clamps if necessary.*
-

When installing new batteries, cables must never be routed between the front battery and the lifter actuator! If so, they can be damaged when the lifter is operated.

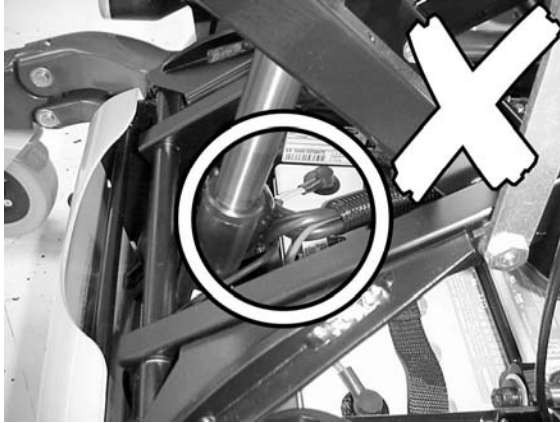

WRONG!



RIGHT!

- Installation takes place in reverse order.



Please note

The battery terminals on the rear battery must face the rear and terminals on the front battery must face the front. The batteries cannot be connected in any other fixing direction.



WARNING: Danger of crushing!

Danger of injury to your hands!

- *Ensure that the actuator head slides into the top holder.*
-

- Run the actuator bolt into the top position and ensure that it slides into the top holder (1).

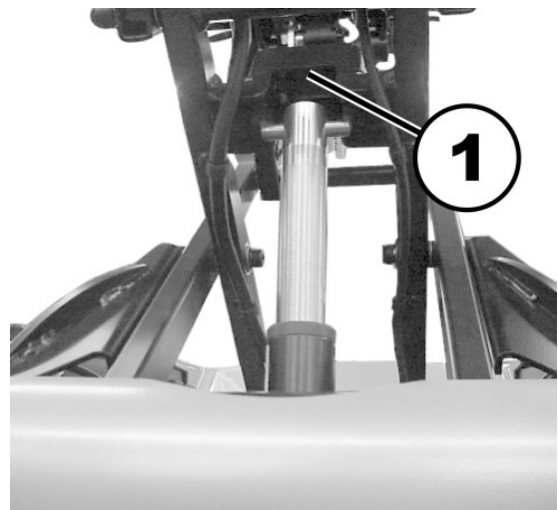

- Lift the seat slightly and loosen the holding mechanism (1). Lower the seat slowly until the lifter weight is resting on the actuator again.

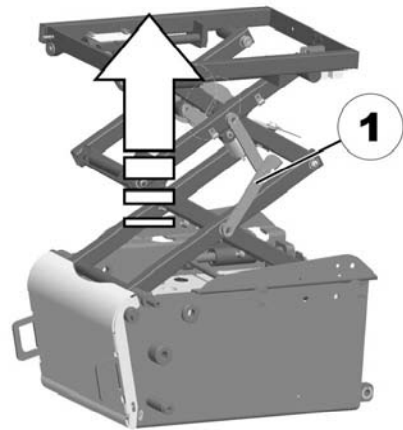

- Check all vehicle functions.
- Check the new battery status and charge completely.

7.4 Replacing the main fuse



CAUTION: Fire hazard!

A short circuit can cause extremely high currents which can result in spark formation and fire!

- Always use an original strip fuse with the approved amperage.
- If the main fuse has blown, first rectify the cause before fitting a new one.



Required parts/tools:

- ring spanner 8 mm.
- replacement fuse
- large flat screwdriver



Note

If the fuse holder is damaged, this can be replaced complete with the battery cable.

- Remove enclosure (1).



- The position of the fuse (1) is shown in the figure on the right.



CAUTION: Fire hazard!

Fitting the incorrect strip fuse causes a fire hazard!

- Only fix the strip fuses in the sequence shown in the image on the right!
- Tighten the nuts with 3.3 or 3.5 Nm!

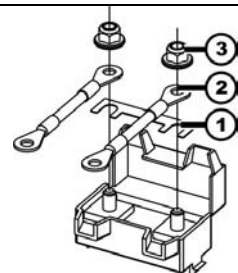

1. Strip fuse
2. Terminal end
3. DIN 6923 nut

- Open the fuse holder cover (1).
- If one of the plate fuses (2) has blown, you must first determine the cause. The main fuse may only be replaced once the problem has been rectified.
- Loosen the nuts (1) which hold the plate fuse (2) secure using an 8 mm socket or ring spanner.
- Insert a new plate fuse (2) and secure using both nuts (1). Close the fuse holder cover again.

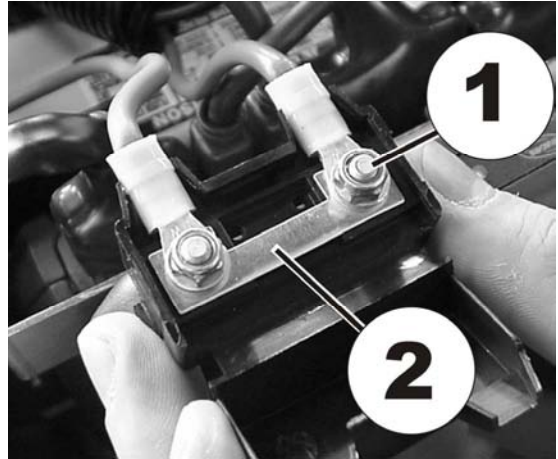

- Insert the fuse holder into the electronics holder again until you hear a click.
- Close the electronics cover.
- Check all vehicle functions.

7.5 Checking the cables

- Run the lifter into the top position.
- Remove enclosure (1).

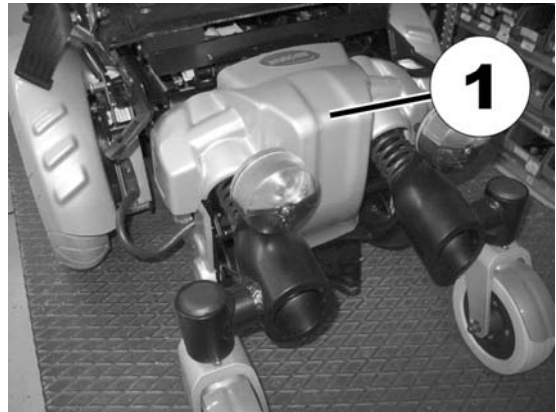

- Check all cables for signs of damage and breakage.
- Pull each plug slightly. It should not disconnect from the socket.
- If a plug is loose, push it lightly into the socket again. It must engage.
- Check whether the plug is sitting firmly in its socket. Otherwise, repeat the previous steps.
- Refix the enclosure.
- Check all vehicle functions.



7.6 Replacing the ACS Remote



Pre-requisites:

- Phillips screwdriver
- To modify a drive programme you will need: Programming software or a Handheld Programmer and the Installation Manual of the ACS Electronics, available from Invacare®.



NOTE

All ACS remotes are supplied with a standard drive programme. If the driving programme has been customised, then you will have to perform this customisation again, after installing the new electronic module.



WARNING!

Every alteration to the drive program can influence vehicle handling and the tipping stability of the wheelchair!

- *Alterations to the drive program must only be carried out by trained Invacare®-dealers!*
- *Invacare® can only assume a warranty for the safe vehicle handling of the wheelchair – in particular tipping stability - for unaltered standard drive programs!*

- Switch off the remote.
- Pull the bus cable (1) out of the remote.
- Loosen the thumb screw (2).
- Pull the remote and the remote holder out of the guiding device.

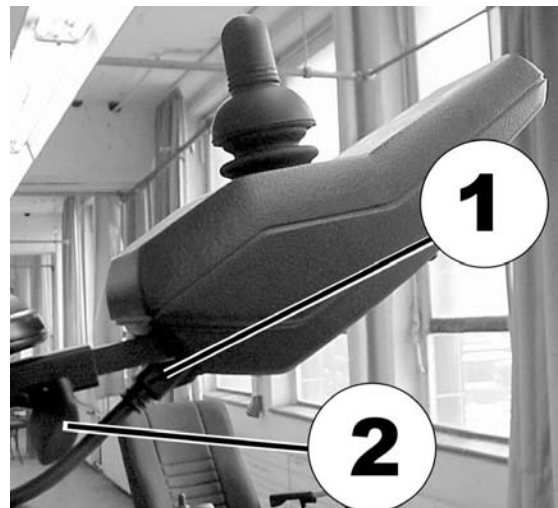

- Unscrew both remote holder screws (1) using the crosstip screwdriver.



- Installation of the remote is carried out in reverse order.
- Update the software, in case a newer version is available.
- Customise the driving programme with the programming software, if required.
- Check all vehicle functions.

7.7 Updating the driving program

The driving programs for electric wheelchairs are continually updated and improved by Invacare®. For this reason, you should check whether the version number is still up to date each time a wheelchair comes in for repairs, and also during regular inspections.

If a newer version is available, the driving program must be updated. The procedure for updating the driving program is described in the user manual of the Wizard software.



NOTE

The electronic system is supplied with a standard drive program. If the driving program has been customised, you have to perform this customisation again, after installing the new driving program.



WARNING!

Every alteration to the drive program can influence vehicle handling and the tipping stability of the wheelchair!

- *Alterations to the drive program must only be carried out by trained Invacare®-dealers!*
 - *Invacare® can only assume a warranty for the safe vehicle handling of the wheelchair – in particular tipping stability - for unaltered standard drive programs!*
-



Pre-requisites:

- Dynamic® Wizard software
 - User manual for the Wizard software
 - For further information on other requirements - such as the minimum system configuration of the PC to be used for programming, necessary programming cables - see the user manual of the Wizard software. You find the latest version of the user manual in the download area on <http://www.dynamiccontrols.com/>.
-

7.8 Checking an actuator motor



Required parts/tools:

- Multimeter
-

- Check the actuator motor electrical resistance. If this is approaching infinity, the motor is probably burnt out. If it is below 1Ω the motor probably has a short circuit. The motor must be replaced in both cases.

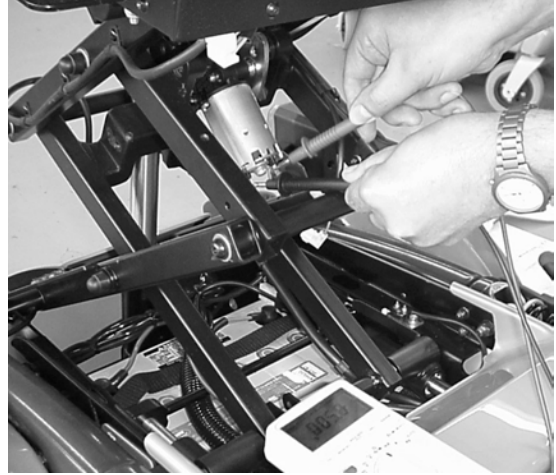

7.9 Adjusting and replacing the speed reduction switch

Find out here how you can adjust and replace the switch that reduces the speed when in the upper lifter position.



Pre-requisites:

- Small pliers
-

- Move the lifter to the upper and lower position several times. In doing so check whether the contact switches.
- If the contact does not switch, bend the plate (1) slightly.
- If the contact is faulty, replace the entire cable harness.



- Check all vehicle functions.

7.10 Replacing the Locking-Gas Cylinder



Note

A second person is required to help when carrying out this work!



Pre-requisites:

- 2nd person
- Two wooden blocks, min. 14 x 14 x 30 cm
- 5 mm Allen key
- 6 mm Allen key
- 6 mm open wrench
- 10 mm open wrench
- Hot air gun
- Medium-strength thread-locking fluid, e.g. Loctite 243
- Torque wrench 0 – 30 Nm (or similar)

Replacing the Locking-Gas Cylinder



WARNING: Danger of crushing!

The mobility device is very heavy. Injury hazard to hands and feet!

- You should seek help from a second person.

Injury hazard caused by uncontrolled movement of the mobility device!

- Switch the power supply off (ON/OFF key).
- Engage the drive.

- Support the wheelchair with wooden blocks.

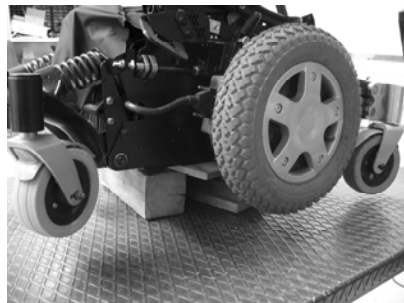

- Remove enclosure (1).



EXPLOSION HAZARD!

If the wheelchair is fitted with pneumatic tyres, the wheel can explode if the air is not released from the tyre before removing the wheel!

- Always release the air from the wheel before it is removed (depress the small tappet in the centre of the valve)!

- Unscrew valve cap.
- Reduce the air pressure in the tyre by depressing the valve tappet (1).
- Loosen and remove the five bolts (2) using the 6 mm Allen key.
- Remove the wheel rim halves and the inner tube from the wheel.

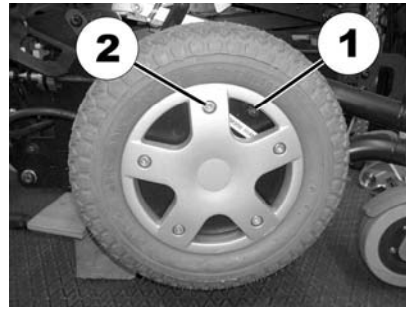

- Loosen and remove the two bolts (1) using the 5 mm Allen key.
- Remove enclosure (2).

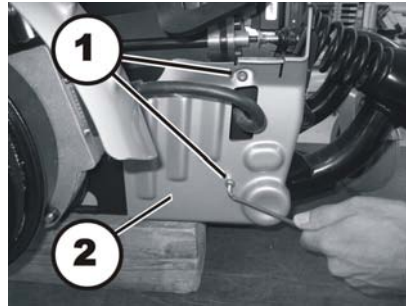

- Loosen and remove the two bolts (1) using the 5 mm Allen key.

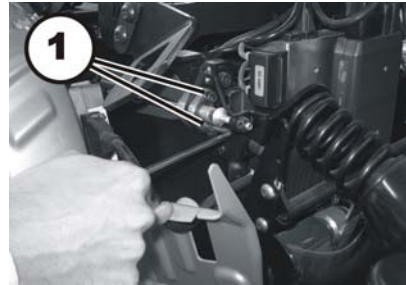

- Heat the two bolts (1) using the hot air gun to release the thread-locking fluid.
- Loosen and remove the two bolts (1) using the 6 mm Allen key.
- Remove swing arm sheet (2).
- Dispose the two bolts (1).

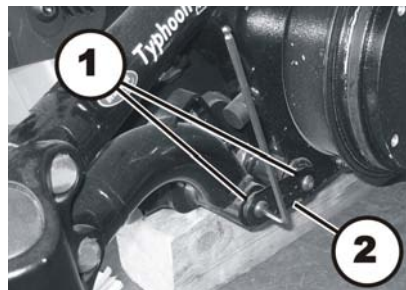

- Move the 2 walking beams (1) about 2 cm on the axles (2) forward.

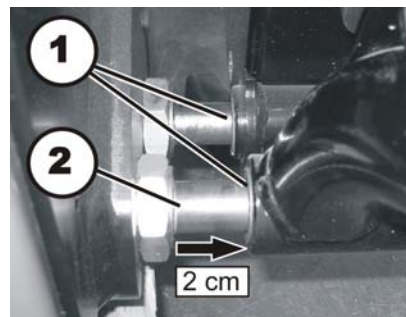

- Loosen and remove the front bolt (1) using the 6 mm Allen key.
- Remove locking-gas cylinder.

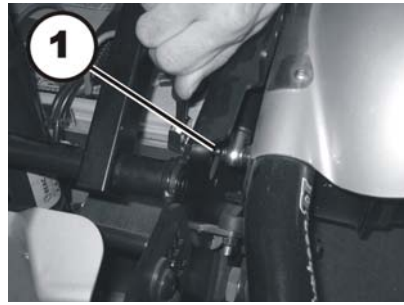

- Dispose old locking-gas cylinder (1).
- Install new locking-gas cylinder (2) in wheelchair.

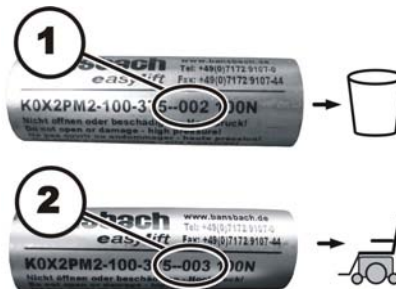

- Locking-gas cylinder rear mount.
- Provide 2 screws (1) with thread-locking fluid.
- Tighten the 2 screws (1) with 10 Nm



- Push in and fix gas cylinder cam (1) e.g. using a screw driver (2).

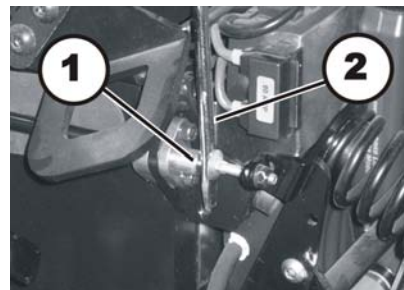

- Provide screw (5) with thread-locking fluid.
- **IMPORTANT:**
Install brass bush (6) and washer (4) and screw (5) in a way that the bush (6) is on the walking beam side - thus on the outside of the wheelchair.

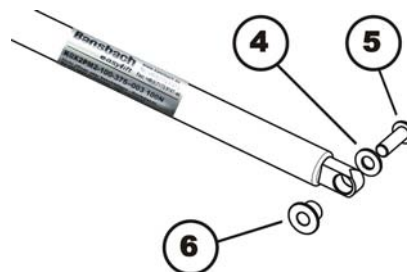

- Tighten the front screw (1) with 25 Nm

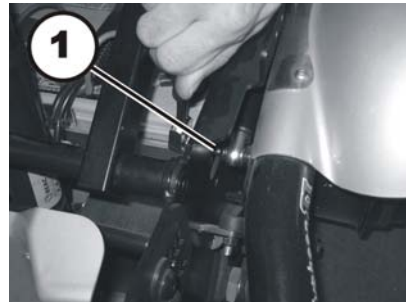

- Move the 2 walking beams on the axles backward.
- Provide 2 screws (1) with thread-locking fluid.
- Refit swing arm sheet (2).
- Screw in the 2 screws (1) using the 6 mm Allen key.

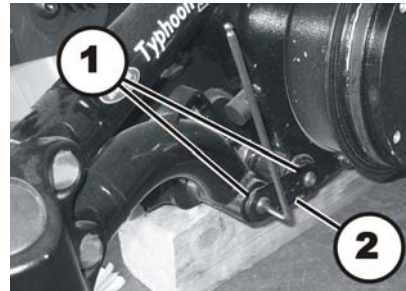

CAUTION!

Material damage hazard.

- *In the next step DO NOT USE thread-locking fluid!*

- Replace the inner tube in the tyre.
- Insert the wheel rim halves once again.
- Insert the screws (2) with Nord-Lock washers and tighten slightly. **DO NOT USE screw locking!**
- Pump a little air into the inner tube.
- Tighten screws (2) with 25 Nm.
- Ensure that the tyre outer is seated correctly.
- Pump the tyres up to 3 bar air pressure.
- Check that the tyre is seated correctly once again.
- Screw the valve cap (1) back on.

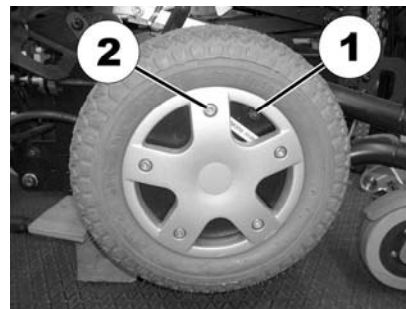

- Repeat all steps on the other side of the wheelchair.
- **IMPORTANT:**
Do not forget to execute the final steps after replacing the second locking-gas cylinder.

Adjusting the setting screw

- Remove wooden block underneath wheelchair.
- **IMPORTANT:**
Wheelchair needs to be on an even surface. All six wheels must touch the ground. Tire air pressure must be correct.

- Loosen check nut (4) using the 10 mm open wrench.
- Using a 6 mm open wrench to screw in the setting screw (3) about 3 mm (± 0.2 mm) to the locking-gas cylinder (1). Use also the adjusting aid (2) DIN 125-A17 washer.

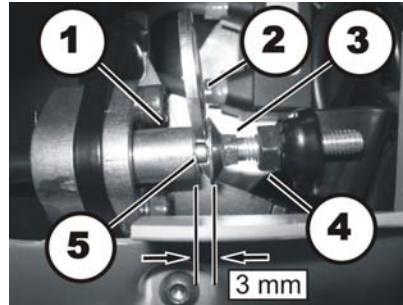

- Hold up setting screw (3) using 6 mm open wrench.
- Tighten check nut (4) using 10 mm open wrench.
- Remove the adjusting aid (2).

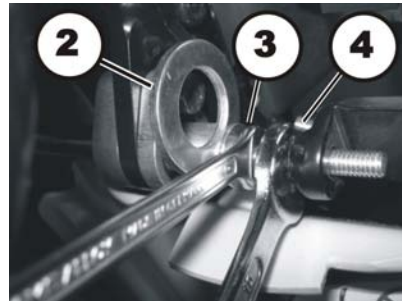

- Refit the cover (2).
- Screw in the 2 screws (1) using the 5 mm Allen key.

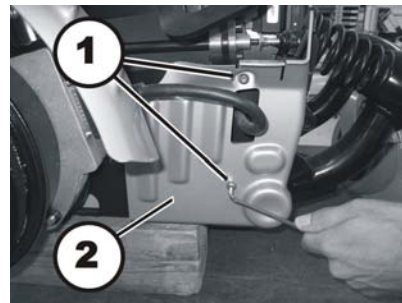

Check adjusting

If the wheelchair stands on a flat surface the front Walking Beam must be flexible, muffled by the gas spring pressure.

- Tilt the wheelchair to the front, rear wheels hang freely, the front beam must block.
- Check the function by slowly driving down an approximately 6 cm high curb.
- Adjust the set screw again if the function is not guaranteed as described in section "Adjusting the setting screw".

Final work

- Refit enclosure (1).

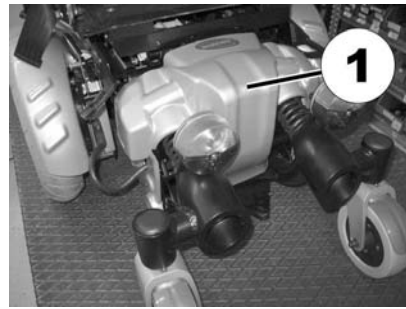

- To conclude, carry out a trial run to test the vehicle functions.

7.11 Replacing the steering head bearings on the front and rear steering wheels



ATTENTION!

Incorrect reassembly can damage the bearings or cause the steering wheels to fall out!

- *The single-row angular ball bearing rings are not identical on both sides ! For this reason they can only be fixed using one correct method!*
- *Follow the fitting manual correctly!*



Required parts/tools:

- small flat screwdriver
- open-ended spanner, 19 mm
- torque wrench

7.11.1 Front steering wheels

- Push a wooden block under the battery case on the side on which you wish to carry out the work so that the wheelchair is supported.



- Remove the black plastic cover (1) over the end of the steering head tube using the small screwdriver.

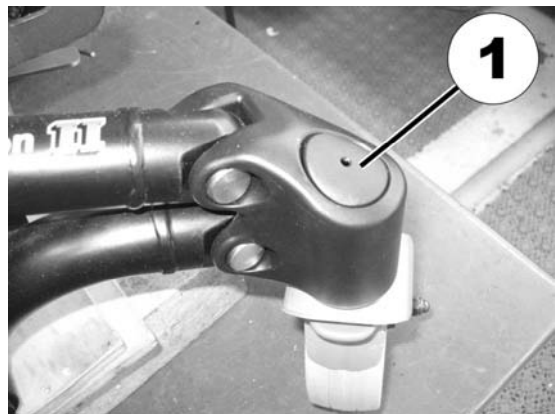

- Loosen the nut (1) with the 19 mm socket spanner and remove it. Hold the wheel so that it does not rotate when you remove the nut.
- Pull the steering head shaft down and out of the steering head tube.
- Remove the washer and the rail ring from the head of the tube. The other rail ring should remain on the shaft.

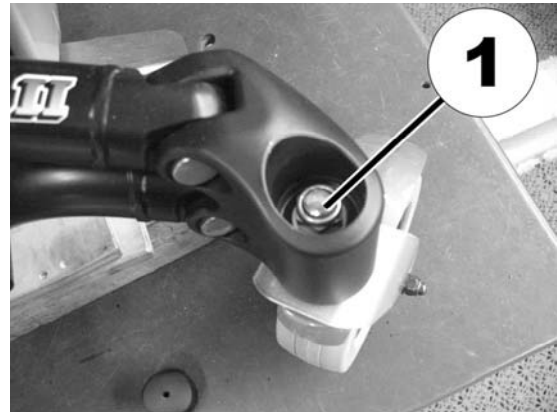

IMPORTANT ASSEMBLY INFORMATION !

The illustrations show the wide border of the rail ring exterior on one side (A) and the narrow border on the interior (B).

The bearings must always be mounted so that the narrow rings are placed opposite each other (interior)! The steering head bolts and the nuts must always press against the wide external edges. Otherwise, the bearings will be pressed apart by the bolt pressure.



The steering wheels should always rotate freely after mounting, but the bearings may not have any play.

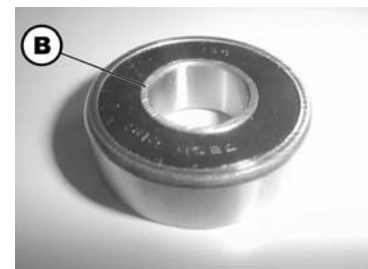

- First tighten the nuts up to 20 Nm +/- 2 Nm.
- Then loosen the nuts slightly.
- Now retighten them up to 15 Nm +/- 1.5 Nm.

7.11.2 Rear steering wheels and

- Remove the black plastic cover (1) over the end of the steering head tube using the small screwdriver.



- Loosen the 19 mm nut with the socket spanner and remove it. Hold the wheel so that it does not rotate when you remove the nut.
- Pull the steering head shaft down and out of the steering head tube.
- Remove the washer and the rail ring from the head of the tube. The other rail ring should remain on the shaft.

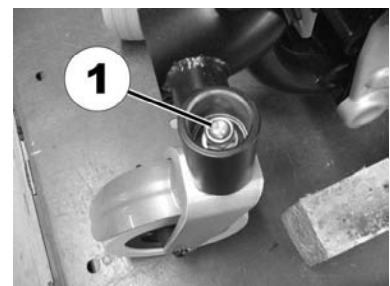

IMPORTANT ASSEMBLY INFORMATION !

The illustrations show the wide border of the rail ring exterior on one side (A) and the narrow border on the interior (B).

The bearings must always be mounted so that the narrow rings are placed opposite each other (interior)! The steering head bolts and the nuts must always press against the wide external edges. Otherwise, the bearings will be pressed apart by the bolt pressure.

The steering wheels should always rotate freely after mounting, but the bearings may not have any play.

- First tighten the nuts up to 20 Nm +/- 2 Nm.
- Then loosen the nuts slightly.
- Now retighten them up to 15 Nm +/- 1.5 Nm.



7.12 Replacing the safety belt



Requirements:

- 10 mm socket spanner
 - 4 mm Allen key
-

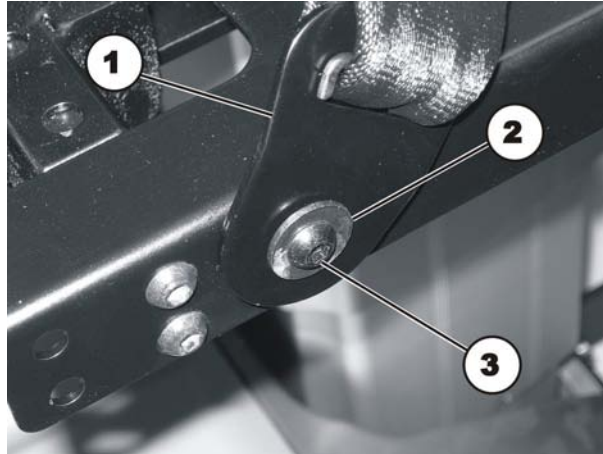

Dismantling the safety belt:

- Remove the plastic cap (5).
- Loosen the bolt (3) and the associated nut (in the figure this is covered) with a 4 mm Allen key and a 10 mm socket spanner.
- Remove the nut incl. the washer.
- Remove the screw incl. the safety belt, the washer (2) and the washer arranged behind.



Note

Another nut is fixed between the two washers (2) and (4) as a spacer so that the belt mounting can rotate freely.

- Replace the safety belt (1).

Refitting the safety belt:

- Refit the parts in reverse order.