

Invacare® | *Etude® Basic*

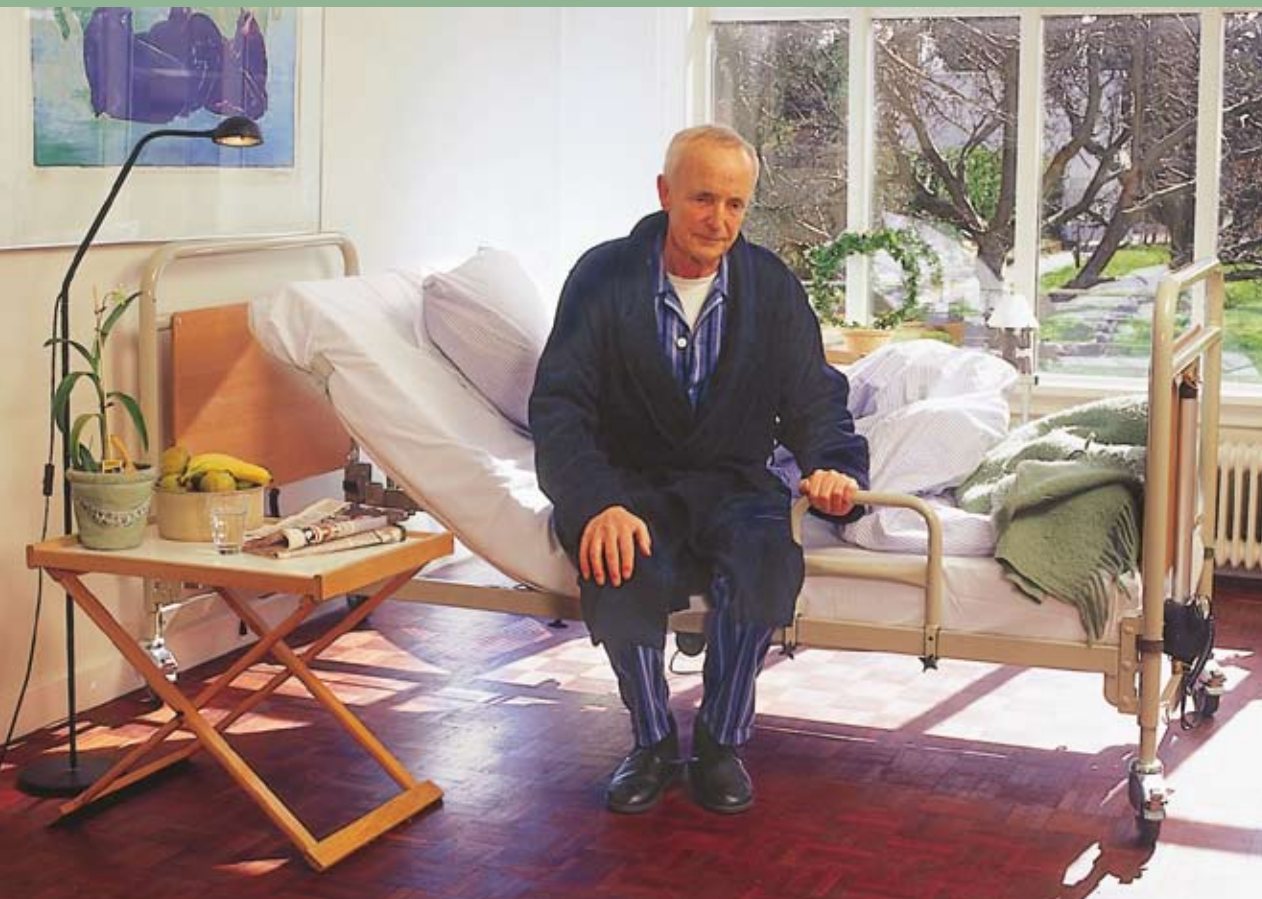

3 year warranty

The Tried and Trusted Home Care Bed

The *Invacare Etude Basic* is a high quality, height adjustable, electric profiling bed that is designed to meet the needs of the modern Community environment. Complete with a four section profiling mattress platform and combined with a dual height range of 33 - 73 or 40 - 80 cm, the *Etude Basic* provides increased comfort for the client and an enhanced working environment for the carer.



Yes, you can.®



Dignity & Independence

The *Invacare Etude's* extensive height range makes getting in and out of bed easier. The bed is supplied complete with cotsides as standard and can be fully adjusted to suit patient needs using the ergonomic hand control, which features light touch push buttons. A range of accessories are available such as support handles to provide additional assistance when moving in and around the bed. In addition an optional 'Soft Control' can be used to synchronise both the head section and knee break.

Easy Handling & Storage

Portability and storage are key benefits of the *Etude*. Its simplistic design allows easy assembly and dismantling without tools and the process can be safely and comfortably managed by one person (each section weighs less than 25 kg). The bed ends can be easily attached to the transport unit making the *Etude* lightweight and manoeuvrable for handling and storage.

Approved Strength & Stability

Probably one of the most robust Community beds on the market, the *Etude* satisfies all the requirements laid down by the European Standard for Nursing Beds EN1970 and carries the official blue stamp from TÜV (German Safety Standards Institute) for its strength, safety and stability. External

approval is complemented by Invacare's stringent demand for consistent high quality throughout. Internal testing, quality control and a continuous improvement environment ensures excellence in the *Etude's* functionality, quality and safety. Invacare is ISO 9001 and ISO 13485 accredited.

Features and Options

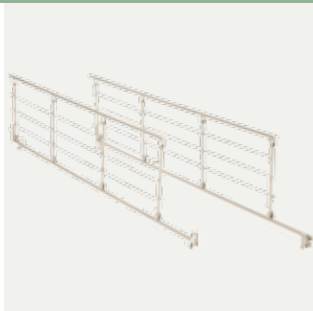

Invacare Scala Basic 2
Foldable steel side rail. Compliant with the new standard for beds IEC 60601-2-52.

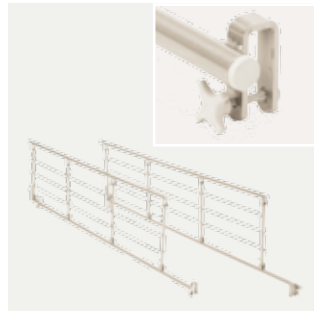

Invacare Scala Basic Plus 2
Foldable steel side rail with plastic inserts at the mounting brackets. Compliant with the new standard for beds IEC 60601-2-52.



Invacare Scala Medium 2
Foldable steel side rail for higher mattresses. Compliant with the new standard for beds IEC 60601-2-52.

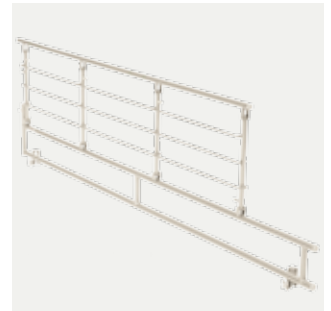

Invacare Scala Decubi 2
Foldable steel side rail for extra high mattresses. Compliant with the new standard for beds IEC 60601-2-52.

Features and Options



Transport unit

For easy storage and enhanced portability. The **Etude Basic** can be delivered fitted to a transporter kit. (Available on request)



Mattress Extension Support

Allows the mattress platform to be extended by 10 cm or 20 cm to suit many size requirements.



Double Height Positions on Bed Ends

Designed to suit the carers environment and equipment needs, the built-in, double-brackets offer the choice of height ranges of 33 - 73 cm or 40 - 80 cm.



Safe Support in Bed

Lifting pole with safe, adjustable grip handle. Can be attached to either left or right side.



Support Handles

Extra help for the patient getting in and out of bed. Available in 5 different sizes.



ACP-Box

By using the ACP-box, all handset functions can be blocked. This ensures that clients cannot inadvertently operate the bed whilst the carer is not present.



Well-Fitted Cable Network

Cables are designed to be hung on the bed frame - as a result, there are no loose cables or opportunities for cables to get tangled or trapped under the bed. N.B. Fitted with UK plug as std.



Curled cables for easy handling

The use of curled cables helps to avoid leads becoming trapped within sections whilst profiling.







Easy Maintenance Motors

Motors can be dis-engaged without the need for tools; cabling between the control unit and the motor is easy to change.

Please see *Invacare Bed Accessories* brochure for more accessories.

Technical data

Etude Basic						
	Width outside: 92 cm Width inside: 90 cm	Length outside: 222 cm Length inside: 208 cm Matress: 200 cm	Height adjustable: 33-73 or 40-80 cm	Matress support dimensions: 4-sectioned: 85-24-35-56 cm	0 - 70° Backrest angle	0 - 18° Thigh angle

Etude Basic				
	0 - 25° Legrest lift	11° Tilt option*	4-sectioned: 78 kg	SWL 180 kg / 28.5 stone Max. user weight 145 kg /23 stone

* Please notice that the tilt function is only practised for users under medical supervision.

NB/ The bed must not be used by patients under 12 years of age, or by patients with body size equivalent to an average 12 year old or smaller.

For mattress compatibility, please refer to the user manual which can be found at www.invacare.co.uk

Frame colour and wood work



Products, Options and Features can be subject to change.

INVACARE® Limited
Pencoed Technology Park - Pencoed -
Bridgend CF35 5HZ
Tel: +44 1 656 776 222
Fax: +44 1656 776 220
E-mail: uk@invacare.com
www.invacare.co.uk
Sales Order E-mail:
ordersuk@invacare.com

INVACARE® Ireland Ltd
Unit 5 - Seatown Business Campus
Seatown Road - SWORDS - County
Dublin
Tel. +353 1 8107084
Fax +353 1 8107085
Email: Ireland@invacare.com
www.invacare.ie

© 2010 Invacare® International Sarl
All rights reserved.

All information quoted is believed to be correct at time of print.
Invacare® reserves the right to alter product specifications without prior consultation.

Etude Basic - UK - 09/2010 - 1426220