



Invacare® **Action®** NG

User Manual

EN



*This manual MUST be given to the user of the product.
BEFORE using this product, read this manual and save for future reference*



Yes, you can.®

Foreword

The information contained in this manual is subject to change without notice. Some information is submitted under copyright – all rights reserved. Any information in this document cannot be photocopied or duplicated without prior written authorization by Invacare.

As the European and world's leading manufacturer of wheelchairs, Invacare endeavours to supply a wide range of wheelchairs to meet all the needs of the user in everyday life. However, final selection of the wheelchair rests solely with the user and his/her qualified health advisor.

Proper and efficient use of the wheelchair that you have chosen is based upon the medical prescription which was issued for you on the basis of your pathology and the nature of your disability.

Your wheelchair is especially designed to be used indoors, and with certain restrictions outdoor.

(Please look at  paragraphs ; part A General Guidelines). Please comply with the traffic regulation.

EN1

Stamp of the Distributor

EN

Introduction

Dear Customer

Thank you for purchasing an Invacare wheelchair.

This model was designed to provide you with all the benefits and features to meet your needs. Only quality components were selected for your wheelchair based upon rigorous inspections during the entire manufacturing process.

EN2

This manual describes the operating limits of your wheelchair, maintenance operations and adjustments that you or your assistant can make.

However, all the repairs (except for inner tubes) as well as some adjustments, require specific technical training and, therefore, must be performed by your distributor.

The *Invacare*® **Action**® **!NG** is designed for both indoor and outdoor use with the purpose of helping people who are not able to walk over a long distance.

Even though your Invacare® wheelchair has been designed to provide a long and trouble free life it is inevitable that wear, tear and usage will eventually render the product unusable. Invacare® recommends that the average usable life of this product is five years, providing the product has been correctly maintained according to the manufacturers recommendations.

TABLE OF CONTENTS

A. GENERAL GUIDELINES

1. Safety and operating limits

	Page
1.1. Reaching an object from the chair	4
1.2. Transferring to other seats	6
1.3. Tilting	7
1.4. Tilting, Kerbs	7
1.5. Stairways	8
1.6. Slopes	8

2. Operating instructions

2.1. Folding and Unfolding the wheelchair	9
2.2. Wheelchair propulsion	10

3. Safety inspection and maintenance

3.1. Performance control	11
3.2. General inspection	11

4. Transportation

4.1. Observations before transport of wheelchairs in vehicles	13
4.2. Restraint systems	13

5. Summary of warranty terms

5.1. Standard terms	15
5.2. Limitation of liability	15

6. Operating instructions for optimal safety

B. DESCRIPTION OF YOUR WHEELCHAIR

1. Presentation

1.1. Introduction	16
1.2. General description	16

2. Adjustments

2.1. Seat elements	17
2.1.1 Seat upholstery	17
2.1.2 Type of backrest	18
2.1.3 Backrest upholstery	19
2.1.4 Footrest supports	20
2.1.5 Armrests	21
2.2. Frame	22
2.2.1 Side frame	22
2.2.2 Folding system	22
2.2.3 Seat height adjustment	22
2.3. Rear wheel	23
2.3.1 24" wheels	23
2.3.2 Handrims	24
2.3.3 Axles	24
2.4. Castors	25
2.4.1 8" wheels	25
2.5. Brakes	25
2.5.1 Manual brakes	25
2.5.2 Hub brakes	25
2.6. Seating options	26
2.6.1 Seat options	26
2.6.2 Propulsion options	28
2.6.3 Safety equipment and options	29
2.6.4 Other options	30

3. Specification and tool

3.1. Standard wheelchair specifications	30
3.2. Tools for adjustments and regular maintenance (Not supplied)	31
3.3. Dimensions and labelling	31

A GENERAL GUIDELINES

1. Safety and operating limits

For a safe operation of your wheelchair, the following parameters should be observed :

- Stability and balance

Your wheelchair has been designed to provide the stability you need during normal daily activities.

Any movement in the wheelchair will have an impact on the position of the centre of gravity, which may lead to the wheelchair tipping and a fall.

To improve your safety when you move a lot or you transfer your weight from one place to another, we recommend using seat belts.

- Weight distribution (figure 1)

Many actions cause the user of a wheelchair to reach out, lean over or move about within the wheelchair and outside it. Any movement you make whilst sat in your wheelchair will move the combined centre of gravity (G_c) of you and the wheelchair (G_w). You will remain stable in the wheelchair whilst the line of your combined centre of gravity lies within

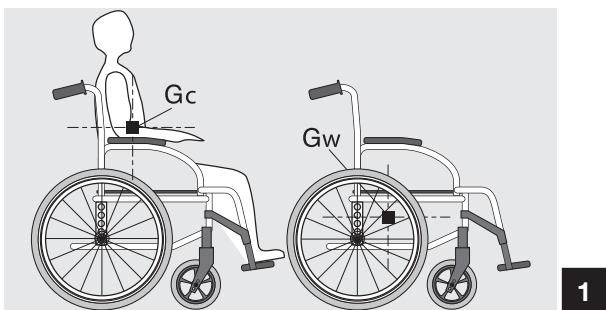

the points of contact of the forward and rear wheels with the ground.

- Weight Limit

The maximum recommended weight of the user is 127 kg.

However, the level of activity is an essential factor.

For example, an active user who weighs 75 kg may subject the wheelchair to more stress than user who weighs 100 kg. To this purpose, we recommend that you consult your retailer when choosing the model of wheelchair based upon your daily life style.

1.1. Reaching an object from the chair

The limitations on reaching out from a wheelchair indicated in the following diagrams have been calculated based on a representative sample of wheelchair users:

- Only the arms should be extended beyond the seat of the wheelchair. (figure 2).

- In any case the body and head shouldn't remain without the boundaries of the seat. (figure 3).

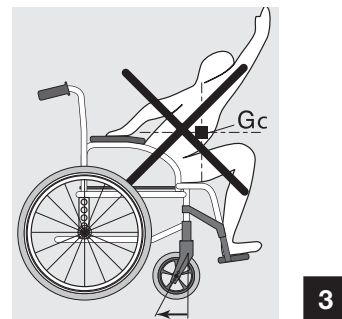
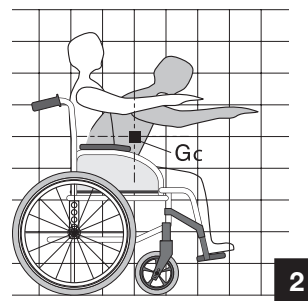

1.1.1 Leaning forward

Do not extend your chest beyond the armrest (figure 4). In order to reach an object in front of you, you must lean and bend down ; therefore, you must use the castors as a tool (pointing them forward) to maintain stability and balance. An accurate alignment of the wheels is essential for your safety (figure 5).

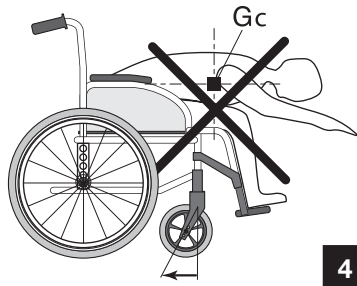

4

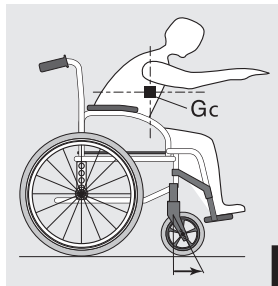

5

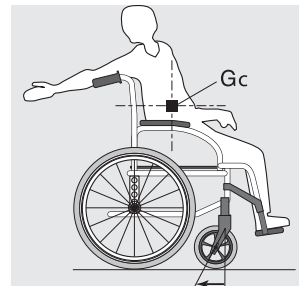

6

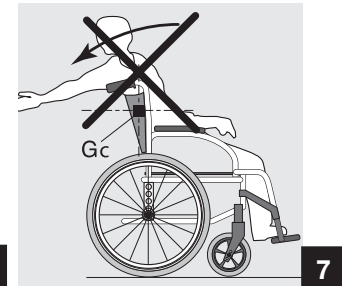

7

1.1.2 Leaning backward

Position wheelchair as close as possible to the desired object so that you can simply pick it up by stretching your arm while sitting in the chair in a normal position (figure 6). In any case, do not lean backwards because you may cause the chair to tip (figure 7).

Warning :

The hanging of additional load (back pack or similar items) onto your chair backposts can affect the rearward stability of your chair.

This can cause the chair to tip backwards causing injury.

Therefore, Invacare® strongly recommend the use of anti-tippers (available as an option) when using your backposts with additional load (back pack or similar items).

1.2. Transferring to other seats

1.2.1 Sideways transfer

This may be done without assistance provided that you are sufficiently mobile and have a strong enough torso.

- Move the wheelchair as close as possible to the seat to which you would like to sit, with the castors pointed forward.

Lock the rear wheels by applying the brakes.

Fold both footplate up and push the footrest/legrest to the side, remove / swing away the armrest to facilitate the transfer.

Shift your body towards the place where you want to sit while distributing your weight to the arms and hands (figures 8 & 8A).

- While moving from the wheelchair to the seat, your body will have little or no support. Where possible use a transfer board during transfers.



1.2.2 Front transfer (figure 9)

If you are more or less able to stand up and if your upper body is strong and mobile enough, you can transfer forward to another seat.

If you find this movement difficult, we recommend that you obtain some assistance from an attendant or carer to ensure the transfer is as smooth and safe as possible.

Lock both brakes and ensure both castor wheels are facing the forward position.

Please note that the brakes should not be used in any case as support for transfers. Fold the footplate up, then grip firmly the armrest handle, take care of your nails on the skirt-guard edges.

Push on your arms to easily lift yourself up and the attendant can help you to finalise the transfer to the place where you wish to sit.

Warning :

- Position yourself as close as possible to the place where you wish to sit.

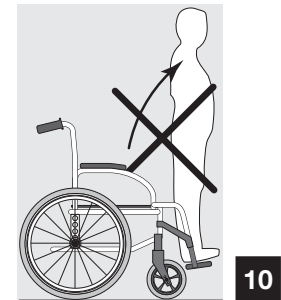
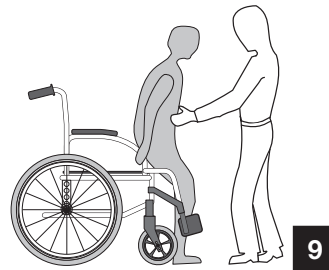

- When transferring, position yourself as far back as possible in the seat to prevent breaking screws, damaging the seat upholstery or causing the wheelchair to tip forward.
- Lock the two brakes ; they should not be used in any case as support for transfers.
- Never stand on the footrests when you are getting in or out of the wheelchair (figure 10).

1.3. Tilting (balancing on the rear wheels)

For greater safety, this operation must be performed by an attendant. The attendant should be aware of the required physical effort and use appropriate positioning in order to relieve the strain on his/her back (keep a straight back and bend your knees during this operation).

To tilt the wheelchair, the attendant must firmly grab the handles making sure both are properly fixed. Warn the occupant in the wheelchair before tilting it and remind him / her to lean backwards and make sure that both feet and hands of the user are clear of the wheels.

Place a foot on the footstep tube and move continuously until the chair reaches the equilibrium point. At this stage, the assistant will feel a difference in weight distribution, which usually occurs at approximately 30°. At this point, the wheelchair can get over the obstacle easily. Finally, the attendant slowly and gradually lowers the front down to the ground, while firmly holding the handles.

Warning :

- Be aware of detachable parts such as armrests or legrests : they must **NEVER** be used as lifting supports as they may be inadvertently released, resulting in possible injury to the user and / or attendant.
- Do not lower the wheelchair suddenly, even if it is several centimetres from the ground, as this may result in injury of the user.

1.4. Tilting, Kerbs

To get on the pavement :

- Method 1 (figure 11)

The attendant positions the wheelchair in front of the pavement facing forward. Press down on the lower tube of the frame as well as pulling on the push handles. Attendant tilts the wheelchair backwards until the castors reach the pavement; attendant pushes the wheelchair forward until the rear wheels are against the kerb and again pushes the wheelchair until the rear wheels climb over the kerb.

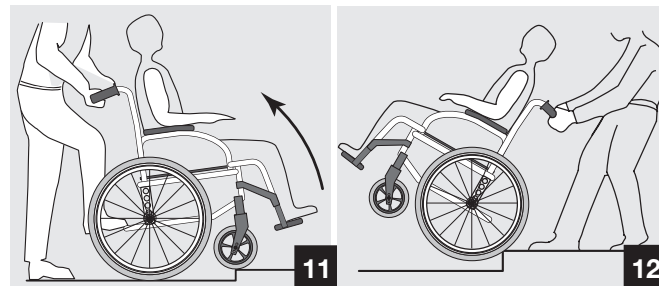

- Method 2 (figure 12)

In this case, the attendant stays on the pavement and tilts the wheelchair in a backwards position with the rear wheels against the kerb. The attendant tilts the wheelchair backwards until it is balanced and pulls the wheelchair with a steady movement until the rear wheels climb over the kerb ; then he / she lowers the castors, while making sure that the chair is far enough on the pavement so that the castors do not fall into empty space.

To get off the pavement :

The attendant positions the wheelchair facing forward on the pavement and tilts it backwards until it is balanced, then he/she pushes the wheelchair forward until the rear wheels touch the road after getting over the obstacle; then, he / she gradually lowers the castors to the ground.

1.5. Stairways

Because this is a difficult movement, we recommend using two attendants, one in front of the wheelchair and one behind the wheelchair.



Warning :

we recommend that users over 100 kg in weight do not use this stairway manoeuvre !

To climb stairways (figure 13) :

After tilting the wheelchair to the point of equilibrium, one assistant (at the back) holds the wheelchair up against the first step grasping the handles firmly to lift.

The second assistant, lifts the wheelchair above the stairs, while holding firmly a fixed part of the frame, and holds it while the first assistant takes a step and repeats the operation. The wheelchair must not be lowered until the last step has been passed and the chair is clear of the stairs.

To descend stairways :

Same operation as above, however, reverse steps as above.

Warning :

- Do not attempt to lift the wheelchair by any removable parts (such as armrests, legrests or footrests).

- Avoid using an escalator which may lead to serious injury in the event of a fall.

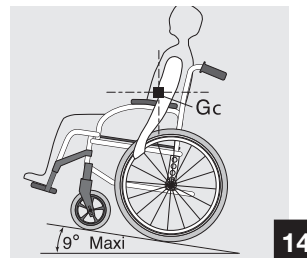

1.6. Slopes

It is recommended to avoid using ramps with a slope higher than 9° . The wheelchair risks tipping over in the event of spinning or side movement (figure 14).

Upward slopes (figure 15) :

Lean the upper body forward and your centre of gravity will move forward to a more stable position. Now move the wheelchair forward with short quick pushes on the hand rims to maintain speed and direction control. If you want to rest, apply both brakes when stopping.

Downward slopes (figure 16) :

Lean backward cautiously and your centre of gravity will move backward to a more stable position. Now let the hand rims slide in your hands. Be ready to react at any moment to control speed and direction.

Warning :

Avoid turning suddenly and never try to climb and descend a ramp diagonally (figure 17).

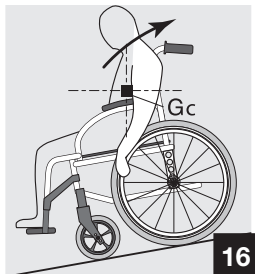
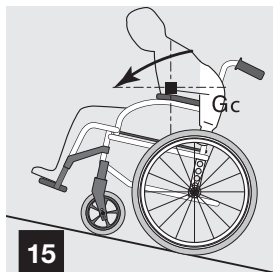

Warning :

It is recommended to avoid using ramps with a slope greater than 9 degrees and do not attempt to turn whilst on a slope. The wheel position is usually factory set and should not be change unless by the direction of a competent person who must have assessed the impact of the change on your stability in normal use.

2. Operating instructions

2.1. Unfolding and Folding the wheelchair

2.1.1 Unfolding the wheelchair (figure 18) :

- With one hand, grab the armrest or the seat support tube on one side of the wheelchair and slightly tilt it towards you (so that the rear wheel and castor lift from the ground) ;
- With the other hand, push on the seat tube until upholstery is fully extended and seat tube sits in receiver.
- Then, engage the two manual brakes, open the footrest/legrest and check the ground clearance (footrest/ground)

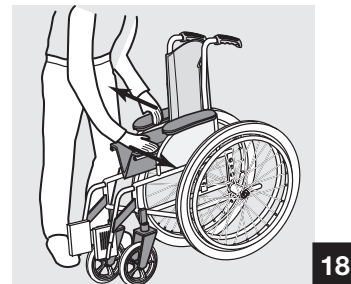
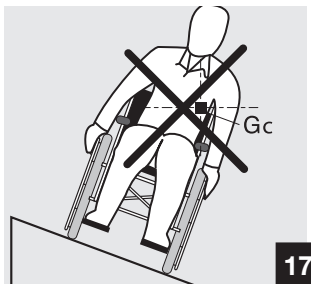

distance - see paragraph B-2.1.4). You can now sit down in the wheelchair.

2.1.2 Folding the chair (figures 19 and 20) :

- Fold and lock the footrest/legrest toward the front of the wheelchair.

- Swivel the plates into the vertical position. Using both hands, take the centre front and back edges of the seat upholstery and lift it. Or, tilt the wheelchair to one side and close it using the handles on the backrest.

Warning :

- Fold the wheelchair while keeping the seat upholstery upwards to avoid damage by the folding system.
- Caution possible finger pinch.

2.2. Wheelchair propulsion

Self propelling wheelchair propulsion is achieved through the use of the handrims mounted on the wheels.



19



20

The distance between the wheels axle position and the seat height can be adjusted to allow you to hold the handrims properly, and various accessories can be added to improve the grip (anti-slip plastic coated, etc.).

Qualified medical and paramedical staff will be able to provide you with advice regarding the propulsion which is best adapted to your disability. Any wheels adjustments to the set up of your wheelchair (see paragraph 2.2.2) should only be performed at the direction of a competent person who has fully risk assessed the implication of any changes to the wheelchair configuration.

2.3. Lifting the wheelchair

First, fold the chair (see paragraph 2.1.2), always lift the wheelchair by gripping the frame at the points (A) shown in the figure 21.

 **Warning :** Never lift the wheelchair by removable parts (armrests, footrests). Ensure the backrest posts are securely in place.

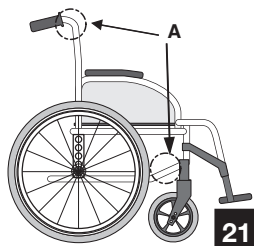

21

3. Safety inspection and maintenance

3.1. Performance control

As the user, you will be the first to notice any possible operational defects with your wheelchair. The following table indicates the easiest troubleshooting symptoms to identify and the preliminary inspection that you can perform.

In the event that the symptoms persist after adjusting the pressure in the tyres, please consult your retailer.

The inner tubes of the wheels are the only components that you can repair yourself (see paragraph B-2.3).

If the screws and nuts are not tight enough or loose, the axle fork angle is not perpendicular to the ground, please consult your retailer to get a competent person to re-set them to the correct position and tighten appropriately.

(Recommended torque minimum : M5 = 4 Nm; M6 = 7 Nm & M8 = 17 Nm)

The wheelchair swerves to the right	The wheelchair swerves to the left	The wheelchair turns or moves slowly	The castors lift	Creaking and clinking	Play in the wheelchair	Inspections
●	●	●				Make sure that pressure in the pneumatic tyre is correct (cf. § B-2.3)
		●	●	●	●	Make sure that the bolts are tight
●	●		●			Make sure that the 2 castors come in contact with the ground at the same time

3.2. General inspection

Your distributor, who has the required technical expertise, is responsible for any wheelchair repairs.

We recommend that you take the wheelchair to your retailer at least once a year for a complete inspection.

Regular maintenance allows the identification and replacement of defective and worn parts, which improves the daily operation of your wheelchair.

Regular inspections to be performed by you or your assistants :

a. General

Make sure that the wheelchair folds and unfolds easily.

Make sure that the wheelchair moves in a straight line. (no resistance or deviation)

b. Manual brakes

Make sure that the manual brakes do not touch the moving tyres.

Make sure that the manual brakes operate easily.

Make sure that the joints are not worn and do not have play.

c. Folding system

Check the folding system for worn or distorted parts.

d. Skirtguard/armrest upholstery

Make sure that all the fittings are properly tightened.

e. Armrests

Make sure that the armrests are firmly attached, but easy to remove.

f. Armpad

Make sure that the armpads are in good condition.

g. Seat and backrest upholstery

Make sure that the upholstery is in good condition.

h. Rear wheels

Make sure that the wheel nuts and precision bearings are tight.

Make sure that the wheels are parallel to the frame.

i. Handrims

Check for rough patches.

j. Spokes

Make sure that the spokes are not distorted, loose or broken.

k. Castors

Make sure that the axle is tight by turning the wheel the wheel must gradually come to a stop.

l. Fork/steering tube

Make sure that all the fittings are well tightened.

m. Pneumatic and solid tyres

Check the pressure of the pneumatic tyres (Front=250 kPa, Rear=350 kPa) check the wear of the solid tyre tread.

n. Cleaning and disinfection

Cleaning: Use only damp clothes and gentle detergent.

Do not use abrasive or scouring liquid. Rinse the wheelchair with a high-pressure cleaning or ordinary jet of water depending on how dirty the chair is. Do not aim the jet towards ball bearings (front & rear wheels, fork axles) and drainage holes. Make sure you dry the wheelchair if it is wet (e.g. after washing it or going out in the rain).

Disinfection: Spray or wipe disinfection using a tested and recognised product is permitted.

Please pay attention to the manufacturer's instructions of the medical product disinfectant you are using.

4. Transportation

Transport of wheelchairs in vehicles

The *Invacare® Action® I* Range has been tested for safety in collisions according to ISO-7176-19:2001,

Invacare® Action® I Range can be used for transport in vehicles that have been specially adapted for this purpose.

The wheelchair must be securely fastened in the vehicle according to the methods described on the following pages.

Remember that the best solution is always to move the user from the wheelchair into a normal car seat and to stow the wheelchair safely and securely in a separate compartment.

Test no : S11723 (Self Propulsion)

Date : 2011-07-29

Customer : Invacare France Operations

The safety restraint devices used in this test must be approved according to ISO-10542-1:2012. We have chosen to work with Unwin, a well-known quality manufacturer of safety restraint devices for wheelchairs. Restraint system manufacturer may improve its products, please contact them for more details.

Test no : S11556 (Transit version)

Date : 2011-11-04

Customer : Invacare UK Ltd

4.1. Observations before transport of wheelchairs in vehicles

- We recommend that wheelchair users should transfer to the seat of the vehicle and use the installed restraint system of the vehicle whenever feasible.
- The wheelchairs are tested in a basic configuration. The use in other configurations has not been tested. Please contact your dealer for further information.
- Auxiliary wheelchair equipment is either secured to the wheelchair or removed from the wheelchair and secured in the vehicle during transit. (i.e. table trays).
- Alterations or substitutions are not to be made to points of the wheelchair or to structural and frame parts without the written consent of Invacare®.
- A wheelchair-anchored posture belt with metal buckle must be fitted across the wheelchair occupant in addition to the lap and diagonal occupant restraint (3-point belt).
- Belt restraints are not to be held away from the body by wheelchair components or parts such as armrests, postural restraints, wheels, etc. (Picture 22)
- The wheelchair must be securely fastened in the vehicle with an ISO 10542-1:2012 approved 4-point belt system, according to the methods described in the manual.
- The occupied wheelchair must be tied down in an forward-facing position, with the parking brake applied.
- The wheelchair backrest should be positioned as close as possible to 90 degrees.

Please observe that even if these products and recommendations are provided in order to increase safety, injury to vehicle occupants still might occur in the event of a collision or other accidents and no guarantee is given in this respect.

Correct and incorrect placements of 3-point belt (picture 22).

4.2. Restraint systems (picture 23A, detail A)

* Non contractual picture, only for information !

Please refer to best practice recommended instructions from the safety belt manufacturer.

A. Front restraints with straps (picture 23A & detail A)

1. Connect the front straps around the front part of the frame. (See location of the attachment labels).
2. Release brakes and apply tension front straps by pulling the wheelchair backwards from the rear.
3. Re-apply wheelchair brakes.

B. Rear restraints (pictures 23B for self propulsion & 23C for Transit version)

1. Attach the snap hooks on the rear straps to the rear orange ring (A) just below the backrest tube bracket.
2. If the chair is not equipped with orange rings, attach the snape hooks on the rear straps to the frame just above the rear wheel attachments.
3. Tighten the straps.

C. Posture belt

1. The posture belt is mounted on the back frame (picture 24 & detail C).
2. Check that the posture belt on the wheelchair is correctly fastened.

If posture belt on the wheelchair is missing we recommend that the user should transfer to the seat of the vehicle, if possible. The posture belt should be used in addition to but never as a substitute for an approved passenger restraint system (3-point belt).

D. Fastening of 3-point belt (vehicle safety belt device).

Although all three points may be anchored to the vehicle floor, the diagonal belt passing over the users shoulder should be routed through a point above and behind the seated user which is fixed to the vehicle sides, before passing down to the floor. The 3-point belt should not be kept from the user's body by the parts of the wheelchair.

Note; Remove the neckrest if so equipped, its is not designed or tested to be used as a head support in a vehicle.

22

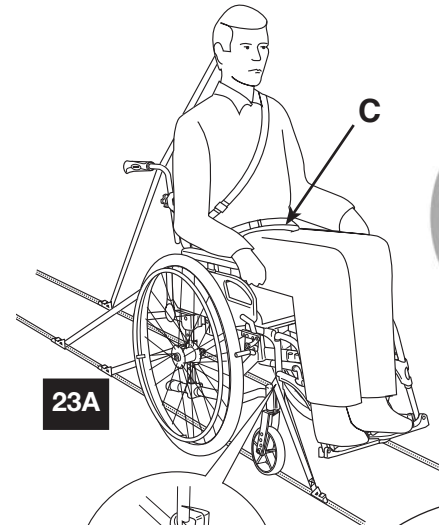

23A

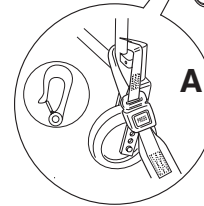

A

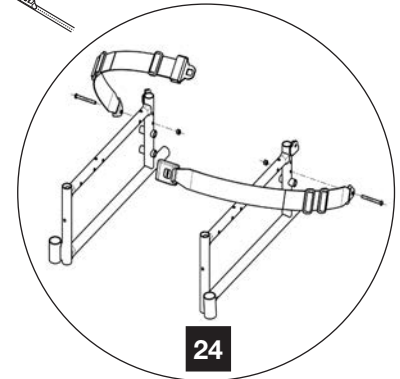

24

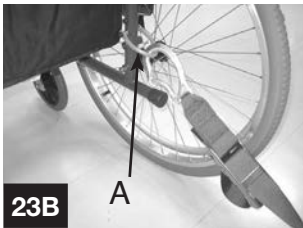

23B

A



23C

5. Summary of warranty terms

5.1. Standard Invacare terms and conditions

This is to certify that your manual wheelchair is warranted by Invacare for a period of 2 years for the frame and crossbars, all others parts 2 years also but subject to the following conditions :

- If a defect or fault is discovered the supplier / dealer from whom the appliance was purchased should be notified immediately.
- The manufacturer will not accept responsibility for damage caused by misuse or non-observance of the instructions set out in the user manual.
- During the period of warranty, any parts that have become defective due to faulty workmanship or materials, will be renewed or repaired without charge by the Invacare dealer/ supplier.
- The warranty will be forfeited should any unauthorised alteration be made to the equipment.
- The Purchaser's statutory rights under the Consumer Protection Act are not affected.

5.2. Limitation of liability

This warranty does not extend to the consequential costs resulting from fault clearance, in particular freight and travel costs, loss of earnings, expenses, etc.

Invacare shall not be liable for :

- Natural wear and tear.
- Inappropriate or incorrect use.
- Defective assembly or setting-up by the purchaser or third parties.
- Defective or neglectful treatment. Use of unsuitable spares.

6. Operating instructions for optimal safety

- Maximum user's recommended weight : 127 kg.
- Do not attempt to reach objects if you have to move forward in the seat.
- Do not attempt to pick up objects from the floor by reaching down between your knees.
- Do not lean over the top of the upholstery back to reach objects located behind you : this may cause you to tip over
- Always engage both manual brakes simultaneously.
- Manual brakes are parking brakes : they must not be used in any way to slow down the wheelchair or as support during transfers.
- Do not tilt the wheelchair (down kerbs or steps) without using an assistant. Press down on the lower tube of the frame as well as pulling on the push handles
- Do not carry the wheelchair up or down stairway or escalators with the user seated in the wheelchair, with only one attendant. This may cause serious injury.
- Do not use the wheelchair unless it has the proper tyre pressure (front = 250 kPa, rear = 350 kPa).
- Do not overinflate the tyres : this may cause the tyres to explode and cause bodily harm.
- Do not expose the wheelchair to a temperature higher than 40°C. (eg : behind the rear window of a car)
- To avoid injury, keep your fingers away from mobile parts (armrests, folding system, legrests/footrests), and maintain good posture before lifting the wheelchair.

 **Warning :** Avoid operating on wet areas as well as gravel, grass, etc. (sand and sea water particularly damage ball bearings). When using the wheelchair inside, we recommend using solid tyre castors, especially when riding on carpet.

B. DESCRIPTION OF YOUR WHEELCHAIR

I. PRESENTATION

I.1. Introduction

Your wheelchair has been factory set before you purchased it. However, it must be specifically adapted to your needs. The following detailed paragraphs describe the various functions and possible adjustments as well as available options. You can make some adjustments yourself, while others can be made only by your dealer.

Important: based upon the selected model or options, your new *Invacare® Action® I NG* wheelchair may be not equipped with all of the components or options which are described in the following pages.

NB: Some models or options are not be available in your country.

 **This is a warning symbol, it is essential that the instructions in these paragraphs are followed in order to prevent personal injury to yourself and others around you.**

 **This is an information symbol about possibility to contact your Dealer for more information.**

I.2. General description (see photo)

Your wheelchair is made of various parts and this manual describes only the main parts. We recommend that you become acquainted with the following terms in order to better understand your wheelchair operation :

- **The seat** consists of the seat and backrest upholstery, the backrest and armrests. This unit is designed to provide optimal comfort.
- **The swing-away footrest support or legrest** : this is the supporting part between the frame and the footrest which swivels to facilitate transfers and can be removed during transport.
- **The footrest** consists of an adjustable tube and the footplate which supports the foot.
- **The folding frame** consists of side frames and a folding system including the seat rails. These parts constitute the frame, which is the supporting component of the wheelchair and its strength is well tested (checked at 127 kg).
- **The steering tube** is the connection between frame and castors
- **The rear wheel** consists of the wheel, axle and handrim. The position of the rear wheels relative to the seated user determines the rearward stability and also the ease by which the user can propel the wheelchair using the handrims. Changing the rear wheel position will have a significant impact on the stability of the user.

• **The castor** consists of the front wheel and the fork. The castors provide front contact with the ground and determine the steering by the direction of the forks.

• **The manual brake** is a parking brake. The two manual brakes are used to secure the wheelchair when stationary.

2. Adjustments

2.1. Seat

2.1.1 Seat upholstery

- Standard seats

• Nylon upholstery seat with or without Velcro fastener : the Velcro fasteners are required for the proper positioning of the cushion (photo 1) ; please make sure that the cushion is properly positioned on the seat.

ⓘ Standard seats are not adjustable; in the event that they become slack, it is recommended that you ask your dealer to replace them.

⚠ Always use upholstery equipped with Velcro fasteners when you have a cushion in order to prevent sliding. Adding a cushion to the seat will raise your height above the ground and can affect your stability in all directions. If a cushion is changed it may also change the users stability.



1

ⓘ Invacare provides a wide range of seat cushions adapted to your needs. Please contact your dealer.

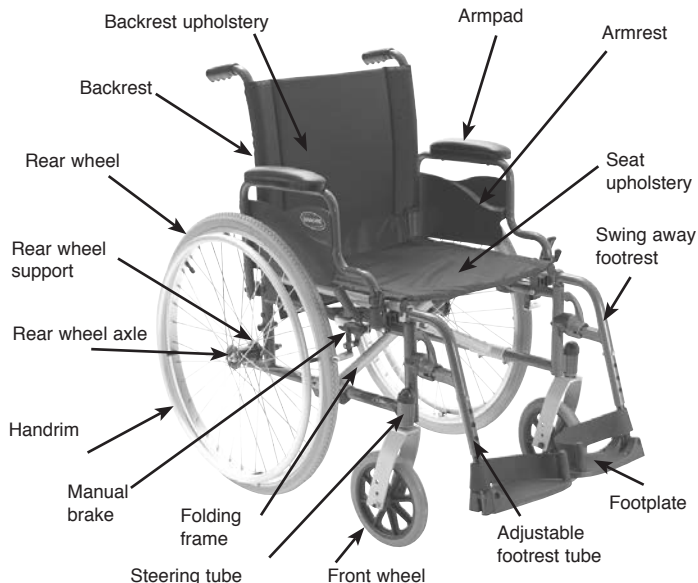

⚠ Make sure that the seat is properly positioned on the 2 seat rails to provide safety and comfort for the user. Keep your fingers away from movable parts to prevent injuries during folding and unfolding !

2.1.2 Type of backrests

- Fixed backrests :

This backrest do not require adjustment (photo 2)

⚠ Make sure push handles are locked fast before use.

- Folding backrest (photo 3) 43 cm backrest height.

EN18

• To save space when transporting folded and unoccupied, operate lever (A) by pulling it and fold the top of the backrest. To return to the initial position, bring the top in the vertical position; it locks automatically.

The intended use of reclining backrest is to get a relaxing, comfort position for the user. It is not indented to be used in a dynamic situation and it should be used on horizontal

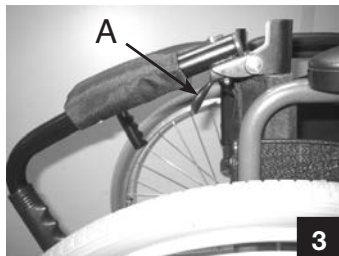

surface when the backrest is reclined (especially when the backrest angle is more than 10°). Anti-tippers are recommended for those who need to feel safer or have a specific usage.

Simultaneously pull the levers (A) to provides the same angle on both sides, release the levers when you reach the desired angle.(Photo 4)

● Mechanical version

There are 4 angles position by step of 10°.

Note : Push on the backrest canes before operating the levers, this is to release the auto-locked security system. (Photo 6).

⚠ It is recommended that this operation be performed only by the attendant. Always make sure that the backrest is locked in place to ensure perfect safety for the user. Keep away fingers from moving parts (levers, cylinders, mechanisms, etc.) to prevent injuries !

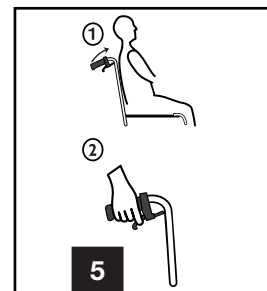

The backbrace (B) (photos 7) links the two push handles and must always be in position on recliner versions (see paragraph 2.6.1). Avoid operating levers (A) (photo 6) during a sideways transfer, for example, in order to prevent destabilising the user's position !

 If you consider there is an excessive free play in the recliner mechanism after a simple visual examination of the ratchet, please contact your Dealer.
To ensure safety for the user, when backrest is reclined, we recommend to use anti-tippers (available as an option).

 Always make sure that the backrest is properly locked in place before the user settles down in the wheelchair to prevent any injuries !

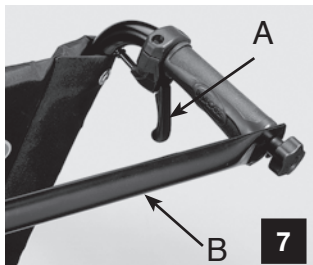

 The hanging of additional load (back pack or similar items) onto your chair backposts can affect the rearward stability of your chair.
This can cause the chair to tip backwards causing injury.
Therefore, Invacare® strongly recommend the use of anti-tippers (available as an option) when using your backposts with additional load (back pack or similar items).

2.1.3 Backrest upholstery

- Standard upholstery backrests

- The padded backrest provides excellent daily comfort for the user who does not need specific support for the upper body.

 In the event that the upholstered backrest slackens, ask for a replacement from your Dealer.

2.1.4 Footrest supports

- Standard footrest supports (photo 8) swing away during transfers and can be removed during transport. Operate lever (A) by pushing sideways and swivelling towards outside or inside in case there is not enough space. To return to the initial position, align the footrest support it locks automatically.

To remove the footrest support, simply pull up after unlocking the assembly. Reverse the procedure to reassemble, while still in the unlocked position.

- Legrest (photo 9) performs the same operation as for the footrest support to swing away or remove the legrest, by operating lever (A) which unlocks the locking system.

Angle adjustment

Pull the lever (B) with one hand while supporting the legrest with your other hand.

When a suitable angle is obtained, let go of the lever and the legrest will lock into one of seven preset positions (schema 10).

The calfpad swings away during transfers and have 3 height adjustment options. After loosening the screw (C), adjust to the desired height and firmly tighten the screw (C).

In addition, it is depth adjustable loosen the screw (D), bring to new position and firmly tighten the screw (D).

Do not place anything heavy, or let children sit on the legrest. It may cause damage to the mechanism.

The distance between the lowest part of the footrest and the ground must be at least 40 mm.

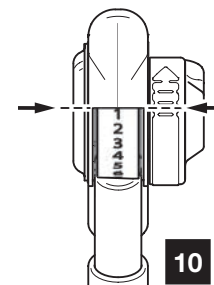
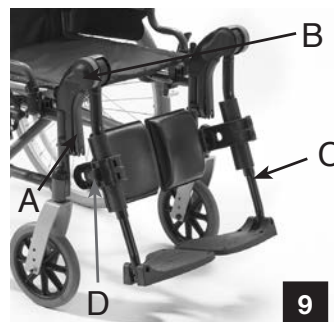
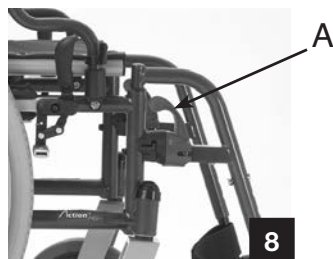

- Footrests (photo 11) : the footplate can be lifted during transfers, footrests are height adjustable and equip with a fixed footplate.

Loosen the bolt (A) to adjust to the desired height, firmly tighten the bolt after adjustment.

Straps for standard legrest : to ensure a good position of the feet, the heelstrap is adjustable by Velcro fasteners.

Note : the standard footrest supports and legrests are mounted in pairs on the wheelchair; whenever you remove them, remember that you have a right side and a left side !

 Never lift the wheelchair by the footrest supports or legrests ! Avoid putting your fingers in the free holes of the hanger, risk of fingers pinch.

Keep your fingers away from movable parts during folding, disassembling or adjustment to prevent injuries !



2.1.5 Armrests

- Swing-away (photo 12)

This range of armrests can be swung away to facilitate transfers.

To swing the armrest away, push down the dog point (A), reverse the procedure to reinsert making sure that the dog point (B) is properly engaged in its housing.

Grip firmly the armrest handle, take care of your nails on the skirt-guard edges.

Push on your arms to easily lift yourself up and the attendant can help you to finalise the transfer to the place where you wish to sit.

 Refer to paragraph 1.2.2. *Front transfer* for safety instructions. Avoid putting your fingers between the tube and the skirt-guard of the armrest, risk of fingers pinch.

When folding back down, ensure that it locks in place, otherwise it can act as a long lever and could fatigue.

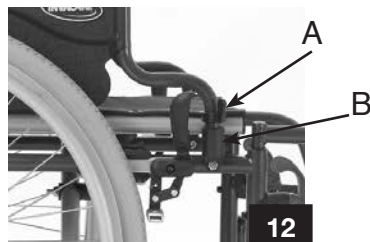

Note : the armrests are mounted in pairs on the wheelchair ; whenever you remove them, remember that you have a right and a left side !

 Never lift the wheelchair by the armrests ! Keep your fingers away from movable parts during folding, disassembling or adjusting to prevent injuries !

2.2. Frame

2.2.1 Side frame

The side frames are designed to accommodate fixation of the front and rear wheels. No adjustment is required on side frames.

EN22

2.2.2 Folding system

It consists of two cross-bars which integrate the seat rails. To fold and unfold your wheelchair, see chapter A “ General ” paragraph 2.1. No adjustment is required on folding system.

2.2.3 Seat Height adjustment (photos 13 & 14)

The *Invacare® Action® I NG* allows 2 seat heights 50 cm (A) or 45 cm (B), always delivered with 50 cm height.

To achieved 45 cm seat height, insert rear wheel quick release axle (see chapter 2.3.3 for detailed operation) into the chassis bearing (B).

Loosen the front wheel bolt (6 mm Allen key), extract the nut from A and insert into B, firmly tighten the bolt.

 The above information is given to the user for information only.

 Any wheels position and/or angle fork adjustments to the set up of your wheelchair should only be performed at the direction of a competent person who has fully risk assessed the implication of any changes to the wheelchair configuration. Please consult your dealer.

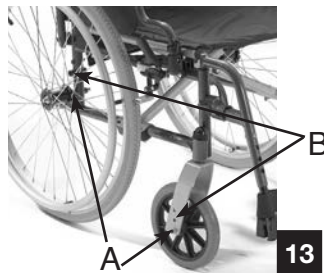

 All these adjustments and changes of position must be performed by a professional technician upon agreement by your prescribing physician. Please consult with your dealer.

2.3. Rear wheels

2.3.1 24" wheels

The 24" (610 mm) rear wheels are spoked or composite wheels.

They can be delivered with pneumatic or solid tyre.

A flat tyre (photo 15) must be removed in order to be repaired. Remove the rim assembly (tyre and inner tube), repair or replace the inner tube, reinsert in the tyre and reposition the assembly on the rim.

Comply with the inflation pressure specified on the sidewall of the tyre.



Note : remember that in order to maintain the interchangeability of the chair wheels equipped with quick-release axles, the pressure in the two tyres should be the same.



Check and adjust the brakes to ensure they are still correctly positioned and function as required.

Never exceed the pressure specified on the sidewalls of the tyre, otherwise, the tyre may explode and cause injuries ! Please make sure that the rear wheel axle is in the same hole on both sides.



Pneumatic tyres wear out. In addition, the roughness of the ground surface and driving have an impact on their longevity. Replace them regularly to avoid punctures caused by puncture.

Please consult with your Dealer.

2.3.2 Handrims

They provide the wheelchair propulsion. They can be made of anodized aluminium.

 Handrims are constantly in contact with your hands. Make sure that they are not damaged !

2.3.3 Axles

- Quick-release axles (photo 16) : depress the button (A) and insert the axle in the wheel hub. Position the assembly in the bearing (B) of the multiple adjustable wheel mounting until it locks in place.

The locking balls (C) must rise above the bearing. No significant side clearance is allowed.

To reduce clearance as much as possible (photo 17), remove the axle and adjust the nut using a 19 mm key ; then block the axle with an 11mm open-end key.

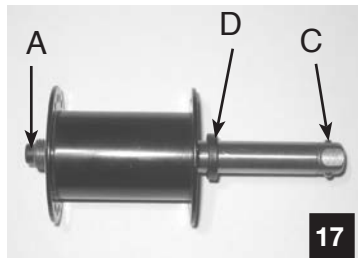
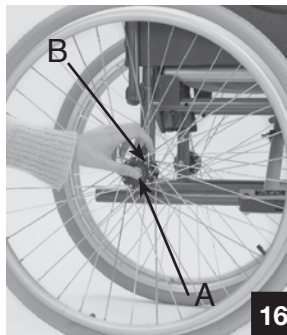

 Always make sure that the spacer (D) is in place. Make sure that the axle and the locking balls are clean. (wipe out every month with a rag soaked with fine oil)

To prevent falls, it is essential that the button (A) and the locking balls (C) are disengaged providing a perfect lock of the rear wheels.

The quick release axle is a precision part, take care of shocks and clean regularly to ensure the good working of the mechanism.

2.4. Castors

2.4.1 8" wheels

The front wheels are available in 8" (200mm) diameter. They can be delivered with pneumatic or solid tyre.

Note : refer to paragraph 2.3.1. for regular maintenance.

2.4.2 Forks

Different fork positions are available based upon the selection of floor-to-seat height, castors and rear wheels.

 Please make sure that the front wheel axle is in the same hole on both sides

 Please take advice from your dealer, if you want to replace a fork or the castors or rear wheels.

2.5. Brakes

2.5.1 Manual brakes

The manual brakes (photo 18) are designed to secure the wheelchair during long stops. They are not intended to slow down the wheelchair or to be used as support during a transfer. They must be operated simultaneously.

In order to brake, push the handle (A) forward. The handle folds back to facilitate transfers. Draw as a preliminary the handle upwards ! Once the brakes are engaged, the wheelchair should not move at all.

Note : brake adjustments are based upon the diameter and type of the wheels. After repairing a flat tyre or in the event of wear of the pneumatic or solid tyre, you may need to adjust the brake(s). To adjust the brake(s), loosen the two screws (B) and slide the brake assembly to obtain the following value between the wheel and the brake shoe in unlocked position (photo 19)

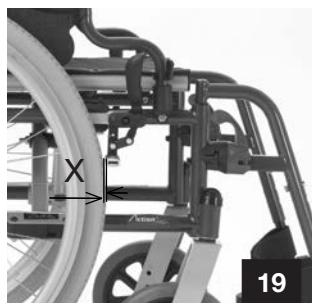
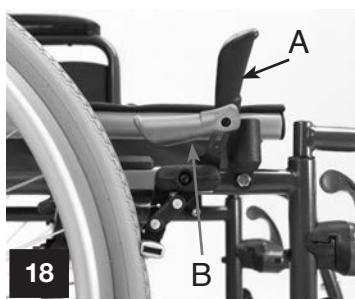

 Please make sure this adjustment is always done as describe whatever the chair configuration is.
Solid tyre X = 4 mm, Pneumatic tyre X = 5 mm

 Firmly tighten the screws (B) after adjustment.
Keep your fingers away from movable parts to prevent injuries !

2.5.2 Hub brakes, attendant control

Besides the functions provided by manual brakes, the hub brakes (photos 20 & 21) provide the slow down (for example, on a slope) and improved safety because they are still efficient when you have a flat tyre !

To slow down, gradually pull the lever (A) upwards. In addition to the manual brakes, you can lock the brake in parking position, with the lever (A) tightened, push the lock (B) to engage it in the notches of the brake handle, then pull the lock up to unlock.

EN25

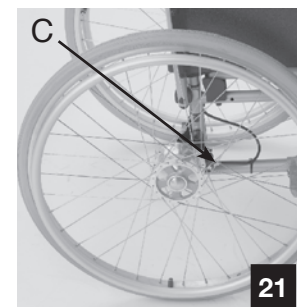
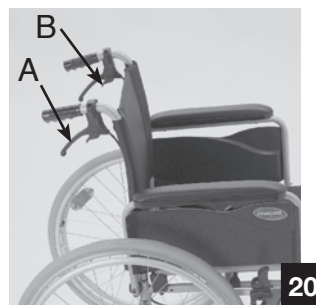

To adjust braking : turn the screw (C) counterclockwise to increase braking force and turn clockwise to reduce it.

 The specific adjustments of hub brakes must always be performed by your Dealer.

 Always operate the two brakes simultaneously and do not take slopes exceeding 5° to ensure perfect control of the wheelchair steering !

Hub brakes are running brakes only, always use the manual brakes to secure the wheelchair during short or long stops.

2.6. Options

2.6.1 Seating options

- Comfort neckrest (photo 22)

It is removable, completely loosen the ball screw (A). It is height adjustable, slightly loosen the ball screw (A), adjust to the desired height, tighten without forcing.

The cushion also is angle, depth and height adjustable by operating simultaneously the lever (B) and screws (C).

Note : make sure that the indexable lever is properly oriented to prevent any bother or injury to the user or attendant.

 Do not adjust the head rest when the user leans on it and check the mounting to the backrest in order to prevent injuries. Remove the neckrest for car transportation.

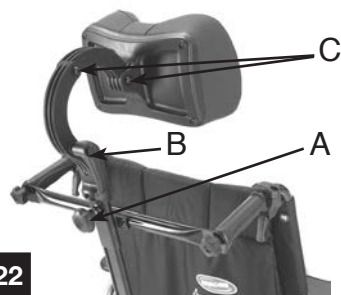

- Back brace (photo 23) : it provides tension to the backrest upholstery and provides the attendant better ergonomics when pushing the wheelchair.

Note : it swings away to facilitate the wheelchair folding; slightly loosen the button (A), pull up and swivel along the backrest until it is in vertical position.

To reposition it, reverse the procedure and firmly tighten the button (A) making sure that the button is properly tighten (B).

 It is important to ensure that the backbrace is correctly fitted and engaged at all times when the chair is in use. (see label on the backbrace) (photo 24). Do not attempt to lift the wheelchair using the backbrace ; it may come loose and the wheelchair and user drop. Keep your fingers away from movable parts to prevent injuries.

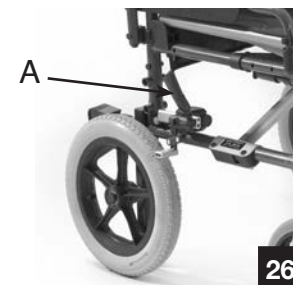
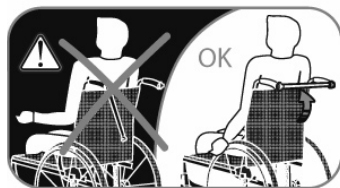

2.6.2 Propulsion options

- Transit version (photos 25 & 26) : the wheelchair is designed to be driven only by the attendant. To facilitate sideways transfers and save space, the wheelchair is equipped with rear wheels of 12" (305 mm) with solid tyres.

The manual brakes (optional hub brake) are only accessible to the attendant; operate the handle (A) to lock the wheelchair in parking position.

Note : for further information about the use of the two types of brakes, see paragraphs 2.5.1 & 2.5.2.

- Dual handrim DHR (photos 27 & 28):

This new quick release system allows the user to drive the wheelchair with a single arm using two handrims on the same wheel with 2 possible side positions of the small handrim (right or left available).

1. The removable and interchangeable rear wheels facilitate transport as well as change of the control side. To dismantle the wheel, pull the button (A) and remove the wheel from its support.

 To prevent falls and injuries, it is essential that the button (A) is fully engaged providing perfect locking of the rear wheels.

EN28

2. Two positions of the small handrim are possible to facilitate the propulsion:

1) internal position

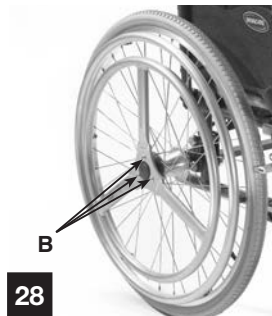

2) external position

Unscrew the three fixation bolts (B), position the small handrim depending on the needed configuration, firmly tighten the three bolts.

To fold the wheelchair, take the transmission shaft (C) off by sliding one part inside the other.

To facilitate this operation move the small handrim forwards to backwards. You can now roll the folded wheelchair.

 Please note that the transmission shaft is an integral part of the wheelchair and the user will be unable to propel the wheelchair without it.

2.6.3 Safety equipment and options

- Safety standard equipment :

Posture belt (photo 29) : to close the buckle belt, engage part (A) into part (B), to open press (C).

The posture belt is mounted on the backrest brackets.

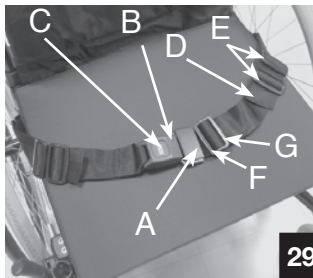

Straps should be adjusted on both sides to suit user body, thread the loop (D) through the mounting on the chair and then through the two plastic buckles (E). It is important that both buckles (E) are used. There is a danger the belt might slip if the belt is threaded through only one.

If the belt has come loose at the metallic clasp it should be adjusted, thread the loop (F) through the plastic buckle (G). Please make sure that the belt cannot slide.

Position the posture belt so that the hip bones can be felt above the belt. As a guide, adjust the length so that there is just sufficient room for your hand to slide between your body and the belt. For ease of use it is recommended that the clasp is kept in a central position where possible i.e. make adjustments to each side of metal buckle belt with double adjuster. Please check your posture belt every week, to ensure that it is in good condition; no damage, fraying etc. and that it is securely fixed to the wheelchair.

 In case the posture belt has to be replaced, the new belt fixation should conform to the scheme enclosed with each belt delivery; the belt should be mounted and adjusted by your regular dealer.

Make sure that the belts do not get caught in the spokes of the rear wheel.

Not to be used as an alternative to a 3-point occupant restraint in a vehicle. A metal buckle posture belt must be used in conjunction with the 3-point occupant restraint.

- Safety optional equipment :

Anti-tippers (photo 30) : prevent back tipping which ensures safety when using a reclining backrest, driving on slopes or crossing obstacles. These are removable : push down the button (A) and pull back. Reverse the procedure to reinstall. Make sure that the dog point (B) protrudes over the frame tube.

Anti-tippers can remain in place when the wheelchair is not used; perform a half-turn by activating the button (B) and rotating.

 The recommended distance between anti-tippers small wheels and floor is 3 to 5 centimetres ; this adjustment is required with reference to the position and diameter of the rear wheel.

Push down the button (C) and adjust the wheels holding tube for the desired distance based upon the preset holes.



30

 Make sure that the dog points locates in and protrudes through its appropriate location hole in the frame tube in order to prevent any falls.

Note : Make sure that the anti-tipper wheel is ALWAYS located out side the rear wheel volume.

All these adjustments and changes of position must be performed by a professional technician because these can affect the stability and the safety of the user ! Please consult your dealer.

2.6.4. Other option

EN30 - Transparent tray (photo 31) : it is positioned on the armpads of the armrests (full length ones only). Slide the tray forward or backward based upon the user's build.

 Do not place very heavy and unstable objects, containers with very hot and corrosive liquids on the tray, which may cause serious injury if they fall.



3. Specifications and tool

3.1. Standard wheelchair specifications

Maximum user weight :	127 kg
Seat width :	41/43/45/48/51 cm
Seat depth :	42,5 cm
Floor/seat height :	50/45 cm
Rear wheel :	24" (610 mm) pneumatic tyre
Castors :	8" (200 mm) solid tyre
Parking brake :	Manual brake with indexed brake shoe
Backrest :	Fixed, Folding
Armrests :	Swing-away
Footrest supports & Legrests :	Removable and swing-away
Seat upholstery :	Black nylon on reinforced upholstery
Frame :	Steel, epoxy coated
Wheelchair average weight :	16,5 kg









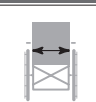

3.2. Tools for adjustments and regular maintenance (not supplied)

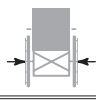
Function	Tool
Brake	5 mm Allen key
Footrest tube	5 mm Allen key
Footplate	5 mm Allen key
Adjustable armrests	5 mm Allen key 10 mm open-end wrench
Armpad	T20 Torx key
Castor	13 mm open-end Wrench(X2)
Quick-release axle	19 mm open-end wrench 11 mm open-end wrench

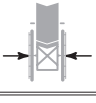
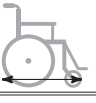
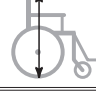
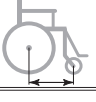
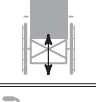

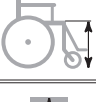
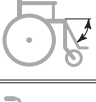
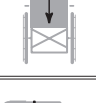















After sale and disposal recommendations

- It is compulsory to use original Invacare® spare parts which you can buy through any Invacare® dealer.
- For repair, please contact your local Invacare® dealer.
- Disposal : the metal parts can be disposed of for scrap metal through recycling. Plastic parts are disposed of as plastic scrap. Disposal must be carried out in accordance with the respective national regulation. Please apply to your municipal authorities/local government for details about local disposal companies.

3.3. Dimensions and labelling

Picture	Description	Min/Max value	Picture	Description	Min/Max value
	Seat effective width (mm)	410/510		Backrest height including headrest (mm)	1045/1350
	Overall width (mm)	615/715		Overall length (mm)	1085
	Width of folded wheelchair (mm)	305		Length without footrest (mm)	855
	Total height (mm)	855/965		Distance between front wheel and rear wheel (mm)	455
	Height from ground to back seat (mm)	430/480		Backrest angle (°)	0/30
	Height from ground to front seat (mm)	450/500		Bracket angle (°)	72
	Backrest height (mm)	410		Distance between footrest and seat (mm)	330/455
	Wheelchair height when backrest is folded (mm)	680/730		Distance between armrest and backrest (mm)	235/340

EN32

Picture	Description	Min/Max value	Picture	Description	Min/Max value
	Fixed armrest height (mm)	240		Maximum obstacle height (mm)	128
	Adjustable armrest height (mm)	N/A		Maximum down slope (0°)	22
	Notched armrest height (mm)	N/A		Maximum up slope (0°)	12/22
	Rear wheel diameter (mm)	610		Maximum lateral super elevation (0°)	20
	Handrim diameter (mm)	530		Removable parts	Wheels Footrests
	Seat plane angle (0°)	3		Overall weight when empty (kg)	16,5 19,2
	Height without rear wheel (mm)	615		User's maximum weight (kg)	127
	Turning circle (mm)	880		Weight of the heaviest removed part (kg)	11,2 13,3
	Cushion thickness (mm)	50		Seat material Fire class	Nylon:M4 BS EN 1021 1/2

Labelling

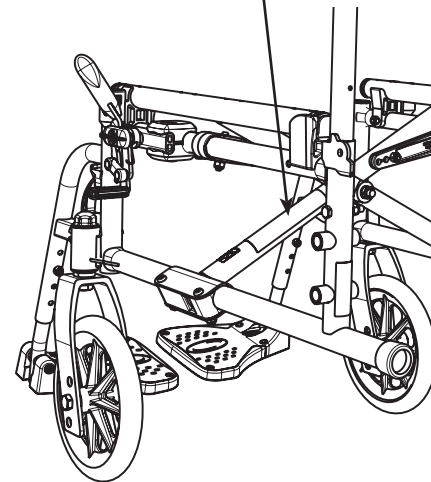
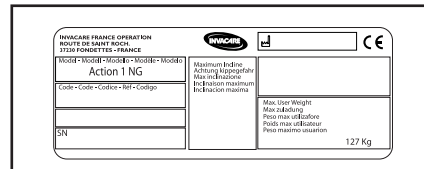

Manufacturer : Invacare® France Operations SAS - Route de Saint Roch - 37230 Fondettes - France



Invacare® Australia Pty Ltd.

1 Ienton Place, North Rocks NSW 2151 **Australia** ☎ (61) 2 8839 5333 **Fax** (61) 2 8839 5353

Invacare® n.v.

Autobaan 22 8210 Loppem (Brugge) **Belgium & Luxemburg** ☎ +32 (50) 831010 **Fax** +32 (50) 831011

Invacare® AIS

Sdr. Ringvej 37 2605 Brøndby **Danmark** ☎ (kundeservice) +45 - (0) 3690 0000 **Fax** (kundeservice) +45 - (0) 3690 0001

Invacare® GmbH

Alemannenstraße 10, D-88316 Isny **Deutschland** ☎ +49 (0) 75 62 7 00 0 **Fax** +49 (0) 75 62 7 00 66

Invacare® European Distributor Organisation

Kleiststraße 49, D-32457 Porta Westfalica **Deutschland** ☎ +49 (0) 31 754 540 **Fax** +49 (0) 57 31 754 541

Invacare® SA

c/Areny s/n Poligon Industrial de Celrà 17460 Celrà (Girona) **España** ☎ +34 - (0) 972 - 49 32 00 **Fax** +34 - (0) 972 - 49 32 20

Invacare® Poirier SAS

Route de St Roch F-37230 Fondettes **France** ☎ +33 - (0) 2 47 62 64 66 **Fax** +33 - (0) 2 47 42 12 24

Invacare® Mecc San s.r.l.

Via dei Pini, 62 I-36016 Thiene (VI) **Italia** ☎ +39 - (0) 445-380059 **Fax** +39 - (0) 445-380034

Invacare® Ireland Ltd

Unit 5 Seatown Business Campus, Seatown Rd, Swords, County Dublin **Ireland** ☎ (353) 1 8107084 **Fax** (353) 1 8107085

Invacare® NZ

4 Westfield Place Mt. Wellington Auckland **New Zealand** ☎ (kundeservice) +64 - 22 57 95 10 **Fax** (kundeservice) +64 - 22 57 95 01

Invacare® AS

Grensvingen 9 0603 Oslo **Norge** ☎ (kundeservice) +47 - 22 57 95 10 **Fax** (kundeservice) +47 - 22 57 95 01

Invacare® PORTUGAL Lda

Rua Estrada Velha, 949 4465-784 Leça do Balio **Portugal** ☎ +351-225105946 **Fax** +351-225105739

Invacare® AB

Fagerstagatan 9 163 91 Spånga **Sverige** ☎ (kundtjänst) +46 - (0) 8 761 70 90 **Fax** (kundtjänst) +46 - (0) 8 761 81 08

Invacare® B.V.

Celsiusstraat 46 NL-6716 BZ Ede **Nederland** ☎ +31 - (0) 318 - 69 57 57 **Fax** +31 - (0) 318 - 69 57 58

Invacare® Ltd

Pencoed Technology Park, Pencoed, Bridgend CF35 5AQ **United Kingdom**
☎ Customer service +44 - (0) 1656 - 776222 **Fax** +44 - (0) 1656 - 776220



Manufacturer

Invacare® France Operations SAS
Route de Saint Roch
37230 Fondettes
France

N°. I545629-EN VD 2013-08-30

Making Life's experiences Possible™



Yes, you can.®