

Invacare® **Action**⁴®



Yes, you can.



User guide



Foreword

The information contained in this manual is subject to change without notice. Some information is submitted under copyright – all rights reserved. Any information in this document cannot be photocopied or duplicated without prior written authorization by Invacare.

As the European and world leader manufacturer of wheelchairs, Invacare endeavours to supply a wide range of wheelchairs to meet all the needs of the user in everyday life. However, final selection of the wheelchair rests solely with the user and his/her qualified health advisor.

Proper and efficient use of the wheelchair that you have chosen is based upon the medical prescription which was issued for you on the basis of your pathology and the nature of your disability. Your wheelchair is especially designed to be used inside, and with certain restrictions outside. Please comply with traffic regulations.

Stamp of the Distributor

Introduction

Dear Customer

Thank you for purchasing an Invacare wheelchair.

This model was designed to provide you with all the benefits and features to meet your needs. Only quality components were selected for your wheelchair based upon rigorous inspections during the entire manufacturing process.

This manual describes the operating limits of your wheelchair, maintenance operations and adjustments that you or your assistant can make.

However, all the repairs (except for inner tubes) as well as some adjustments, require specific technical training and, therefore, must be performed by your distributor.

The Invacare® Action⁴® is designed for both indoor and outdoor use with the purpose of helping people who are not able to walk over a long distance.

TABLE OF CONTENTS

A. GENERAL GUIDELINES

	Page
1. Safety and operating limits	
1.1 Reaching an object from the chair	3
1.2 Transferring to other seats	5
1.3 Tilting	6
1.4 Tilting, road-kerbs	6
1.5 Stairs	7
1.6 Slopes	7
2. Operating instructions	
2.1 Folding and Unfolding the wheelchair	8
2.2 Operating the Wheelchair	9
3. Safety inspection and maintenance	
3.1 Performance control	10
3.2 General inspection	10
4. Transportation	11
5. Warranty	14
6. Summary of operating instruction	14

B. DESCRIPTION OF YOUR CHAIR

	Page
1. Presentation	
1.1 Introduction	15
1.2 General description	15
2. Adjustments	
2.1 Seat elements	16
2.1.1 Seat upholstery	16
2.1.2 Backrest type	17
2.1.3 Backrest upholstery	18
2.1.4 Hangers & footplates	19
2.1.5 Armrests	20
2.2 Folding frame	21
2.2.1 Side frame	21
2.2.2 Double folding mechanism	21
2.2.3 Steering tube	21
2.3 Rear wheel	22
2.3.1 24" & 22" wheels	22
2.3.2 Handrims	22
2.3.3 Axles	23
2.4 Castors	23
2.4.1 8", 6" & 5" wheels	23
2.4.2 Front fork	24
2.5 Brakes	24
2.5.1 Manual brake	24
2.5.2 Hub brakes	25
2.6 Options & accessories	25
2.6.1 Seat options	25
2.6.2 Propulsion options	26
2.6.3 Safety options	26
2.6.4 Tray	27
3 Technical specification and equipment	
3.1 Standard wheelchair specifications	28
3.2 Tools for adjustments and regular maintenance (Not supplied)	29
3.3 Dimensions	30

A GENERAL GUIDELINES

1. Safety and operating limits

For a safe operation of your wheelchair, the following parameters should be observed :

- Stability and balance

Your wheelchair has been designed to provide the stability you need during normal daily activities.

Any movement in the wheelchair will have an impact on the position of the centre of gravity, which may lead to the wheelchair tipping and a fall.

To improve your safety when you move a lot or you transfer your weight from one place to another, we recommend using seat belts.

- Weight distribution (figure 1)

Many actions cause the user of a wheelchair to reach out, lean over or move about within the wheelchair and outside it. These movements cause a change to normal balance, centre of gravity (G) and weight distribution of the wheelchair.

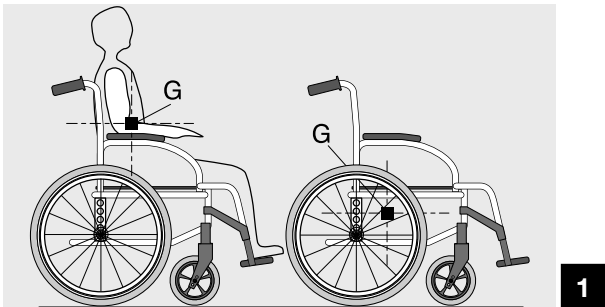

- Weight Limit

The maximum recommended weight of the user is 125kg and 150 kg for 50,5 - 55,5 & 60,5 cm seat width. However, the level of activity is an essential factor. For example, an active user who weighs 75 kg may subject the wheelchair to more stress than that of a user who weighs 100 kg. To this purpose, we recommend that you consult your retailer when choosing the model of wheelchair based upon your daily life style.

1.1 Reaching an object from the chair

The limitations on reaching out from a wheelchair indicated in the following diagrams have been calculated based on a representative sample of wheelchair users:

- Only the arms should be extended beyond the seat of the wheelchair. (figure 2).
- The body and head should remain within the boundaries of the seat. (figure 3).

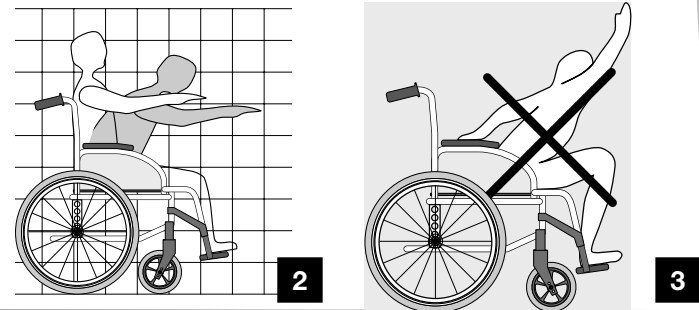

1.1.1 Leaning forward

Do not extend your chest over the armrest (figure 4). In order to reach an object in front of you, you must lean and bend down ; therefore, you must use the castors as a tool (pointing them forward) to maintain stability and balance. An accurate alignment of the wheels is essential for your safety (figure 5).

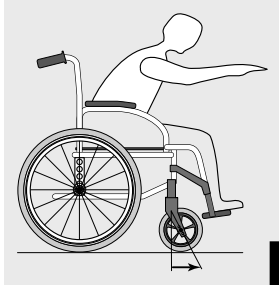
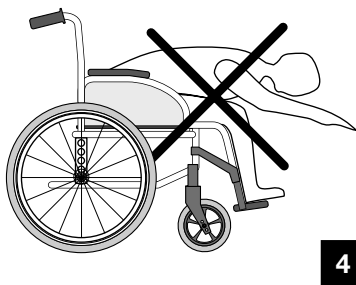

1.1.2 Leaning backward

Position wheelchair as close as possible to the desired object so that you can simply pick it up by stretching your arm while sitting in the chair in a normal position. In any case, do not lean backwards because you may cause the chair to tip (figures 6 and 7).

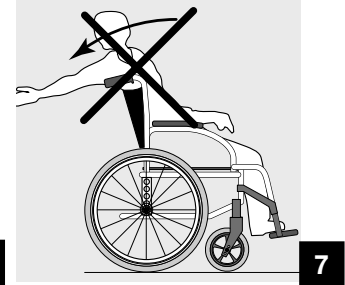

1.2 Transferring to other seats

1.2.1. Sideways transfert

This may be done without assistance provided that you are sufficiently mobile and have a strong enough torso.

- Move the wheelchair as close as possible to the seat to which you would like to sit, with the castors pointed forward. Lock the wheels by applying the brakes. Move the weight of your body towards the seat (figure 8)
- While moving from the wheelchair to the seat, your body will have little or no support. Where possible use a transfer board during transfers.
- If you are more or less able to stand up and if your upper body is sufficiently strong and mobile, you can transfer forward to another seat. Fold the footplate up and push the footrest/legrest to the side, bend your body forward leaning on the two armrests and lift yourself up; then shift your body towards the place where you want to sit while distributing your weight to the arms and hands (figure 9A).

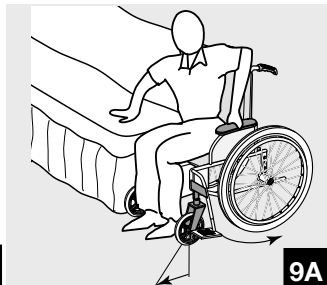

1.2.2. Front transfert (figure 9B)

If you are more or less able to stand up and if your upper body is strong and mobile enough, you can transfer forward to another seat.

As you may find this movement difficult, we recommend that you obtain some assistance from an attendant or carer to ensure the transfer is as smooth and safe as possible.

Lock both brakes and ensure both castor wheels are facing the forward position.

Please note that the brakes should not be used in any case as support for transfers. Then, grip firmly the armrest handle, take care of your nails on the skirt-guard edges.

Push on your arms to easily lift yourself up and the attendant can help you to finalise the transfer to the place where you wish to sit.

 **Warning :**

- Position yourself as close as possible to the place where you wish to sit.

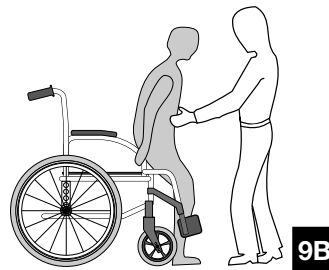

- When transferring, position yourself as far back as possible in the seat to prevent breaking screws, damaging the seat upholstery or causing the wheelchair to tip forward.
- Lock the two brakes ; they should not be used in any case as support for transfers.
- Never stand on the footrests when you are getting in or out of the wheelchair (figure 10).

1.3 Tilting (balancing on the rear wheels)

For greater safety, this operation must be performed by an attendant. The attendant should be aware of the required physical effort and use appropriate positioning in order to relieve the strain on his/her back (keep a straight back and bend your knees during this operation).

To tilt the wheelchair, the attendant must firmly grab the handles making sure both are properly fixed. Warn the occupant in the wheelchair before tilting it and remind him / her to lean backwards and make sure that both feet and hands of the user are clear of the wheels. Place a foot on the footstep tube and move continuously until the chair reaches the equilibrium point. At this stage, the assistant will feel a difference in weight distribution, which usually occurs at approximately

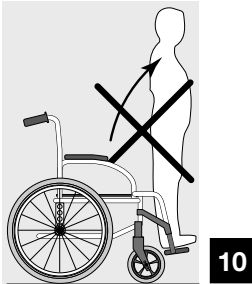

30°. At this point, the wheelchair can get over the obstacle easily. Finally, the attendant slowly and gradually lowers the front down to the ground, while firmly holding the handles.

Warning :

- Be aware of detachable parts such as armrests or legrests : they must NEVER be used as lifting supports as they may be inadvertently released, resulting in possible injury to the user and / or attendant.
- Do not lower the wheelchair suddenly, even if it is several centimetres from the ground, as this may result in injury of the user.

1.4 Tilting, Kerbs

To get on the pavement :

- Method 1 (figure 11)

The attendant positions the wheelchair in front of the pavement facing forward. Attendant tilts the wheelchair backwards until the castors reach the pavement; attendant pushes the wheelchair forward until the rear wheels are against the kerb and again pushes the wheelchair until the rear wheels climb over the kerb.

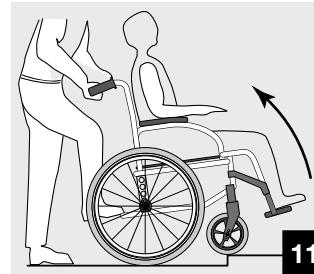

- Method 2 (figure 12)

In this case, the attendant stays on the pavement and moves the wheelchair in a backwards position with the rear wheels against the kerb. The attendant tilts the wheelchair backwards until it is balanced and pulls the wheelchair with a steady movement until the rear wheels climb over the kerb ; then he / she lowers the castors, while making sure that the chair is far enough on the pavement so that the castors do not fall into empty space.

To get off the pavement :

The attendant positions the wheelchair facing forward on the pavement and tilts it backwards until it is balanced, then he/she pushes the wheelchair forward until the rear wheels touch the road after getting over the obstacle; then, he / she gradually lowers the castors to the ground.

1.5 Stairways

Because this is a difficult movement, we recommend using two attendants, one in front of the wheelchair and one behind the wheelchair.

Warning :

we recommend that users over 125 kg in weight do not use this operation !

To climb stairways (figure 13) :

After tilting the wheelchair to the point of equilibrium, one assistant (at the back) holds the wheelchair up against the first step grasping the handles firmly to lift..

The second assistant, lifts the wheelchair above the stairs, while holding firmly a fixed part of the frame, and holds it while the first assistant takes a step and repeats the operation.

The wheelchair must not be lowered until the last step has been passed and the chair is clear of the stairs.

To descend stairways :

Same operation as above, however, in reverse order.

Warning :

- Do not attempt to lift the wheelchair by any removable parts (such as armrests, legrests or footrests).

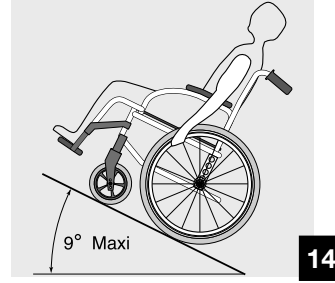
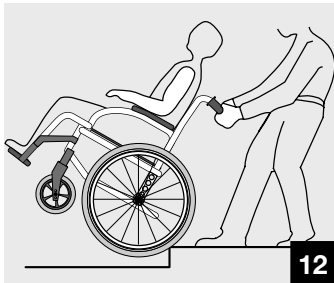

- Avoid using an escalator which may lead to serious injury in the event of a fall.

1.6 Slopes

It is recommended to avoid using ramps with a slope higher than 9°. The wheelchair risks tipping over in the event of spinning or side movement (figure 14).

Upward slopes (figure 15) :

Lean the upper body forward and move the wheelchair forward with short quick pushes on the hand rims to maintain speed and direction control. If you want to rest, apply both brakes when stopping.

Downward slopes (figure 16) :

Lean backward cautiously and let the hand rims slide in your hands. Be ready to react at any moment to control speed and direction.

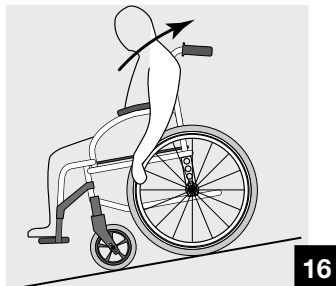
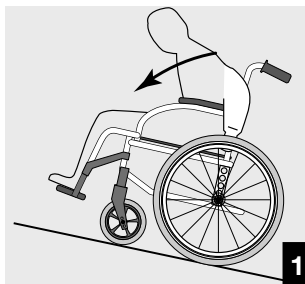

Warning :

- Avoid turning suddenly and never try to climb and descend a ramp diagonally (figure 17).

2. Operating instructions

2.1 Unfolding and Folding the wheelchair

2.1.1 Unfolding the wheelchair (figure 18) :

- With one hand, grab the armrest or the seat support tube on one side of the wheelchair and slightly tilt it towards you (so that the rear wheel and castor lift from the ground) ;
- With the other hand, push on the seat upholstery until the tube supporting the upholstery is fully unfolded. The seat upholstery must be fully extended ;
- Then, engage the two manual brakes, open the footrest/legrest and check the ground clearance (footrest/ground distance - see § B-2.1.4). You can now sit down in the wheelchair.

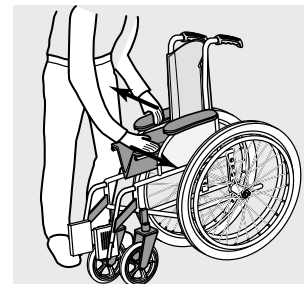
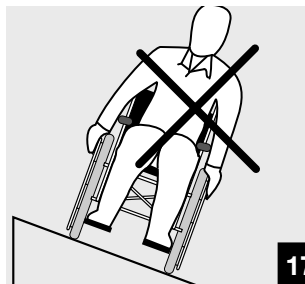

2.1.2 Folding the chair (figures 19 and 20) :

- Fold and lock the footrest/legrest toward the front of the wheelchair.
- Swivel the plates into the vertical position. Using both hands, take the centre front and back edges of the seat upholstery and lift it. Or, tilt the wheelchair to one side and close it using the handles on the backrest.

Warning :

- Fold the wheelchair while keeping the seat upholstery upwards to avoid damage by the folding system.

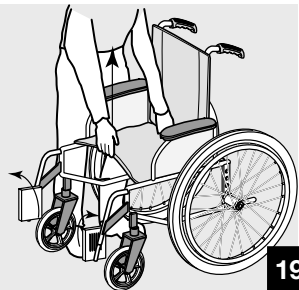

2.2 Wheelchair propulsion

Wheelchair propulsion is provided by the handrims mounted on the wheels. The handrims can be adjusted based upon your height to allow you to hold them properly, and various accessories can be added to improve the grip (anti-slip plastic coated, capstan spigot kit, etc.)

Qualified medical and paramedical staff will be able to provide you with advice regarding the propulsion which is best adapted to your disability.

3. Safety inspection and maintenance

3.1 Performance control

As the user, you will be the first to notice the possible operational defects of your wheelchair. The following table indicates the easiest troubleshooting symptoms to identify and the preliminary inspection that you can perform.

In the event that the symptoms persist after adjusting the pressure in the tyres and tightening screws and nuts, please consult your retailer.

The inner tubes of the wheels are the only components that you can repair yourself (see § B-2.3).

The wheelchair swerves to the right	The wheelchair swerves to the left	The wheelchair turns or moves slowly	The castors lift	Creaking and clinking	Play in the wheelchair	Inspections
●	●	●				Make sure that pressure in the pneumatic tyre is correct (cf. § B-2.3)
		●	●	●	●	Make sure that the bolts are tight
●	●	●				Check the adjustment on the fork angle
●	●		●			Make sure that the 2 castors come in contact with the ground at the same time

3.2. General inspection

Your distributor, who has the required technical expertise, is responsible for any wheelchair repairs. We recommend that you take the wheelchair to your retailer at least once a year for a complete inspection. Regular maintenance allows the identification and replacement of defective and worn parts, which improves the daily operation of your wheelchair.

Regular inspections to be performed by you or your assistants :

a. General

Make sure that the wheelchair folds and unfolds easily.
Make sure that the wheelchair moves in a straight line. (no resistance or deviation)

b. Manual brakes

Make sure that the manual brakes do not touch the moving tyres.

Make sure that the manual brakes operate easily.
Make sure that the joints are not worn and do not have excessive play.

c. Folding system

Check the folding system for worn or distorted parts.

d. Skirtguard/armrest upholstery

Make sure that all the fittings are properly tightened.

e. Armrests

Make sure that the armrests are firmly attached, but easy to remove.

f. Armpad

Make sure that the armpads are in good condition.

g. Seat and backrest upholstery

Make sure that the upholstery is in good condition.

h. Rear wheels

Make sure that the wheel nuts and precision bearings are tight.

Make sure that the wheels are parallel to the frame.

i. Handrims

Check for rough patches.

j. Spokes

Make sure that the spokes are not distorted, loose or broken.

k. Castors

Make sure that the axle is tight by turning the wheel the wheel must gradually come to a stop.

l. Fork/steering tube

Make sure that all the fittings are well tightened.

m. Pneumatic and solid tyres

Check the pressure of the pneumatic tyres (value indicated on the side) check the wear of the solid tyre tread.

n. Maintenance

Do not use any product to clean parts except for the upholstery which can be washed with soap and water only.

Make sure you dry the wheelchair if it is wet (e.g. after washing it or going out in the rain).

Avoid riding on wet areas as well as gravel, grass, etc.



sand and sea water particularly damage ball bearings. When using the wheelchair inside, we recommend using solid tyre castors, especially when riding on carpet. Do not expose the wheelchair to a temperature higher than 40°C (e.g. in a vehicle).

4. Transportation

Transport of wheelchairs in vehicles

The Invacare® Action⁴ has been tested for safety in collisions according to ISO-7176-19, Invacare® Action⁴ can be used for transport in vehicles that have been specially adapted for this purpose. The wheelchair must be securely fastened in the vehicle according to the methods described on the following pages.

Remember that the best solution is always to move the user from the wheelchair into a normal car seat.

4.1 Test report from dynamic safety restraint test (ISO-7176-19)

Test no : P501858A (fixed backrest) & P501858B (Folding backrest), **Customer :** Invacare Rea AB, **Date :** 2005-04-05
Testing to be carried out

Pulse specification : ISO-7176-19

Wheelchair Manufacturer :

Invacare France Opérations SAS

Model : Action⁴

Weight : 15.5 kg (fixed) 16 kg (folding)

Configuration : Forward facing

Safety restraint device Manufacturer :

Unwin Safety Systems

Model : 4 Pt WWR/ATF/K/R

Attachment device : Unwin Low Profile Rail

User safety belt : Manufacturer: Unwin Safety Systems

(www.unwin-safety.com)

Model : 3 Pt WWR/HD/ATF/K/R

Test dummy : Hybrid III

Weight : 76.5 kg

Test configuration

Chassis : Height 46 cm

Backrest : Fixed/folding

Seat : sling type

Armrest : Height adjustable

Legrest : Swing in/swing out

Rear wheel : 24" pneumatic

Castor : 8" x 1/4" solid

Accessories : Heel strap

Tested : 2005-04-05

The safety restraint devices used in this test must be approved according to ISO-10542. We have chosen to work with Unwin, a well-known quality manufacturer of safety restraint devices for wheelchairs.

4.2 Observations before transport of wheelchairs in vehicles

• We recommend that wheelchair users should transfer to the seat of the vehicle and use the installed restraint system of the

vehicle whenever feasible.

- The wheelchairs are tested in a basic configuration. The use in other configurations has not been tested. See user manual, section «Test report from dynamic safety restraint test», for test configuration.
- Auxiliary wheelchair equipment is either secured to the wheelchair or removed from the wheelchair and secured in the vehicle during transit. (i.e. table trays).
- Alterations or substitutions are not to be made to points of the wheelchair or to structural and frame parts without the written consent of Invacare®.
- A wheelchair-anchored posture belt must be fitted across the wheelchair occupant in addition to the lap and diagonal and restraint (3-point belt).
- Belt restraints are not to be held away from the body by wheelchair components or parts such as armrests, postural restraints, wheels, etc. (Picture 22)
- The wheelchair must be securely fastened in the vehicle with an ISO 10542-2 approved 4-point belt system, according to the methods described in the manual.
- The occupied wheelchair must be tied down in an forward-facing configuration, with the parking brake applied.
- The test dummy weight is 75 kg, according to ISO 7176-19, although the chairs are approved for users up to 125 kg or 150 kg.
- The wheelchair backrest should be positioned as close as possible to 90 degrees.
- If possible, a headrest should be used during transit, in order to reduce the risk of neck injury. The headrest should be placed as high as possible.

Please observe that even if these products and recommendations are provided in order to increase security and safety.

Correct and Incorrect placements of belt (picture 21)

4.3 Restraint methods (picture 22)

* Non contractual picture, only for information !

Please refer to best practice recommended instructions from the safety belt manufacturer.

A. Frontal restraints with straps

1. Connect the frontal straps around the frontal part of the frame.
2. Release brakes and tension front straps by pulling the wheelchair backwards from the rear.
3. Re-apply wheelchair brakes.

B. Rear restraints

1. Attach the snap hooks on the rear straps to the frame just above the rear wheel attachments.
2. Tighten the straps.

C. Pelvic belt

1. The pelvic belt is mounted on the back frame (picture 23).
2. Check that the pelvic belt on the wheelchair is correctly fastened.

If pelvic belt on the wheelchair is missing we recommend that the user should transfer to the seat of the vehicle, if possible.

D. Fastening of safety belt

The safety belt should not be kept from the user's body by the parts of the wheel chair.

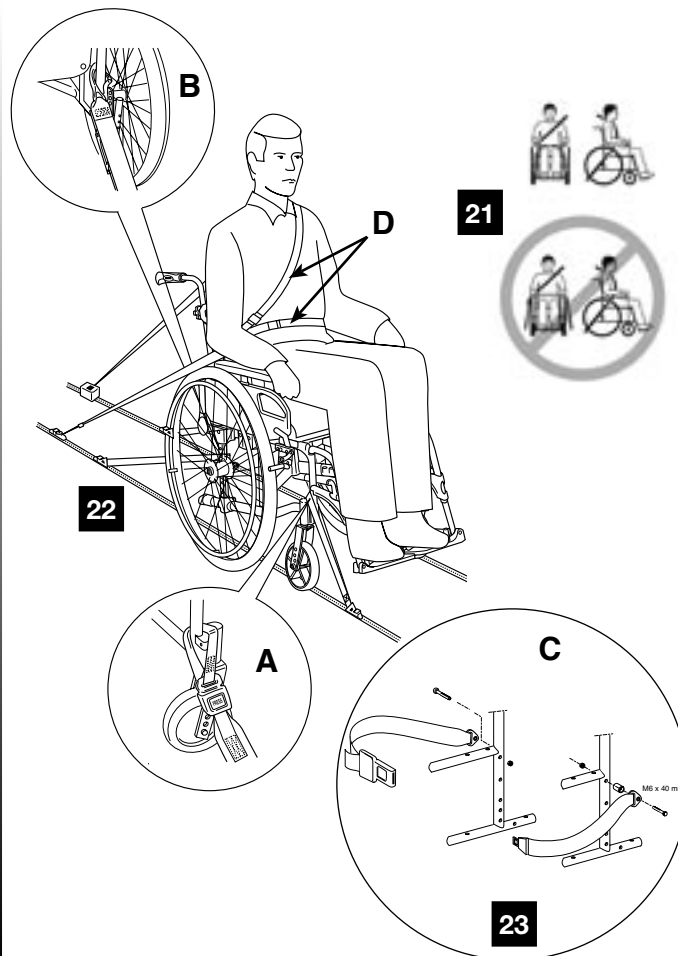

5. Summary of warranty terms

5.1 Standard Invacare terms and conditions

This is to certify that your manual wheelchair is warranted by Invacare for a period of 2 years for the frame and crossbars, all others parts one year, subject to the following conditions :

- Only wheelchairs purchased at the displayed price recommended by Invacare are covered by the Invacare warranty.
- If a defect or fault is discovered the supplier / dealer from whom the appliance was purchased should be notified immediately.
- The manufacturer will not accept responsibility for damage caused by misuse or non-observance of the instructions set out in the user manual.
- During the period of warranty, any parts that have become defective due to faulty workmanship or materials, will be renewed or repaired without charge by the Invacare dealer/supplier.
- The warranty will be forfeited should any unauthorised alteration be made to the equipment.
- The Purchaser's statutory rights under the Consumer Protection Act are not affected.

5.2 Limitation of liability

This warranty does not extend to the consequential costs resulting from fault clearance, in particular freight and travel costs, loss of earnings, expenses, etc.

Invacare shall not be liable for :

- Natural wear and tear.

- Inappropriate or incorrect use.
- Defective assembly or setting-up by the purchaser or third parties.
- Defective or neglectful treatment use of unsuitable spares.

6. Summary of operating instructions for optimal safety

- Maximum user's recommended weight : 125 kg or 150 kg.
- Do not attempt to reach objects if you have to move forward in the seat.
- Do not attempt to pick up objects from the floor by reaching down between your knees.
- Do not lean over the top of the upholstery back to reach objects located behind you : this may cause you to tip over
- Always engage both manual brakes simultaneously.
- Manual brakes are parking brakes : they must not be used in any case to slow down the wheelchair or as support during transfers.
- Do not tilt the wheelchair (down kerbs or steps) without using an assistant.
- Do not carry in the stairways or escalator; user sited in the wheelchair which only one attendant; this may cause serious injury.
- Do not use the wheelchair unless it has the proper tyre pressure as indicated on the side wall of the tyre.
- Do not overinflate the tyres : this may cause the tyres to explode and cause bodily harm.
- Do not expose the wheelchair to a temperature higher than 40°C.
- To avoid injury, keep your fingers away from mobile parts (armrests, folding system, legrests/footrests), and maintain good posture before lifting the wheelchair.

B. DESCRIPTION OF YOUR WHEELCHAIR

1. PRESENTATION

1.1 Introduction

Your wheelchair has been factory set before you purchased it. However, it must be specifically adapted to your needs. The following detailed paragraphs describe the various functions and possible adjustments as well as available options. You can make some adjustments yourself, while others can be made only by your dealer.

Important: based upon the selected model or options, your new Action⁴ wheelchair may be equipped with all of the components or options which are described in the following pages.

 **This is a warning symbol ; you must imperatively follow the instructions that are provided in these paragraphs to prevent personal injuries as well as injuries to people around you !**

1.2 General description (see photo)

Your wheelchair is made of various parts and this manual describes only the main parts. We recommend that you become acquainted with the following terms in order to better understand your wheelchair operation :

- **The seat** consists of the seat and backrest upholstery, the backrest and armrests. This unit is designed to provide optimal comfort.
- **The swing-away footrest support or legrest** : this is the supporting part between the frame and the footrest which swivels to facilitate transfers and can be removed during transport.
- **The footrest** consists of an adjustable tube and the footplate which supports the foot.
- **The folding frame** consists of side frames and a folding system including the seat rails. These parts constitute the frame, which is the supporting component of the wheelchair and its strength is well tested (checked at 125 kg and 150 kg for 50,5 - 55,5 & 60,5 cm seat width).
- **The steering tube** is the connection between frame and castors ; it allows the adjustment of the seat angle.
- **The rear wheel** consists of the wheel, axle and handrim. The rear wheels ensure the rear stability and allow the propulsion of the wheelchair using the handrims.

They are mounted on the multiple adjustment wheel support brackets.

- **The castor** consists of the front wheel and the fork. The castors provide front contact with the ground and determine the steering by the direction of the forks.
- **The manual brake** is a parking brake. The two manual brakes are used to secure the wheelchair when stationary.

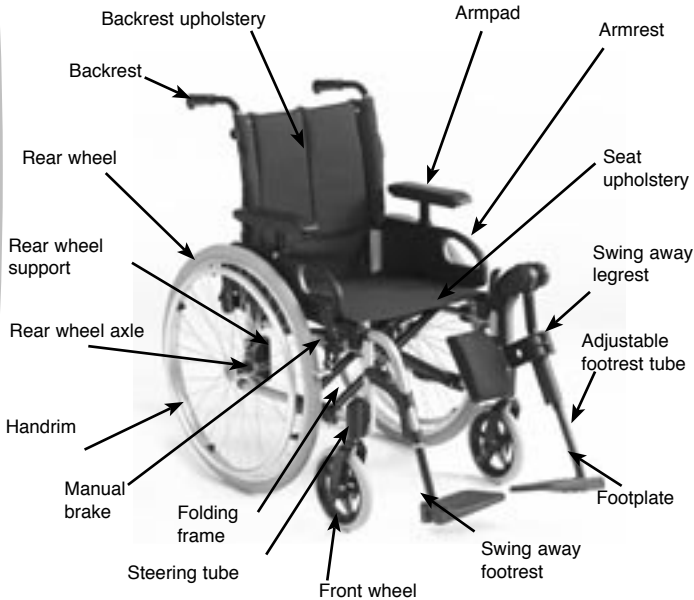

2. Adjustments

2.1 Seat

2.1.1 Seat upholstery

- Standard seats

- Nylon upholstery seat with or without Velcro fastener : the Velcro fasteners are required for the proper positioning of the cushion (photo 1) ; please make sure that the cushion is properly positioned on the seat.

- Padded seat : it provides comfortable support to the user.

▲ Standard seats are not adjustable; in the event that they become slack, it is recommended to request your dealer to replace them.

⚠ Always use upholstery equipped with Velcro fasteners when you have a cushion in order to prevent sliding.

▲ Invacare provides a wide range of seat cushions adapted to your needs. Please contact your dealer.



2.1.2 Type of backrests

- Standard fixed backrests :

This backrest do not require adjustments, they can be equiped with padded backrest or tension-adjustable backrest.

- Height adjustable fixed backrest: (photo 2)

Fold the chair slightly to facilitated the operation, loosen screws (A) with an Allen key (5 mm). Adjust to the desired height and firmly tighten the two screws (A).

- Folding backrest (photo 3)

45 cm backrest height.

• To save space during transport, operate lever (B) by pulling or pushing it and fold the top of the backrest.

To return to the initial position, bring the top in the vertical position; it locks automatically.

 Always make sure that the backrest is properly locked in place before the user settles down in the wheelchair to prevent any injuries !

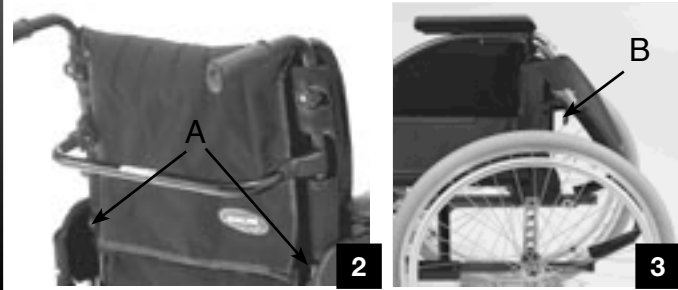

- Reclining backrest 0° - 30° - 39/41/43 or 47/49/51 cm backrest height.

Angle can be adjusted very easily which provides a comfortable rest position :

Simultaneously pull the levers (A) to provides the same angle on both sides, release the levers when you reach the desired angle.(Photo 4)

• Mechanical version

There are 4 angles position by step of 10°.

Note : Push on the backrest canes before operating the levers, this is to release the auto-locked security system. (Photo 5).

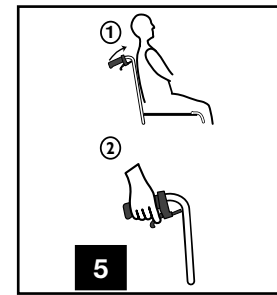
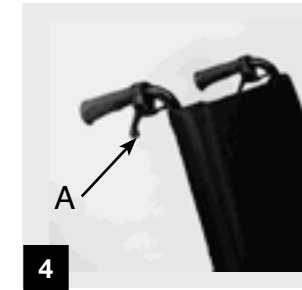

- Gas strut version (0° to 30° continuously (Photo 6).

Pneumatic jacks provides help to raised the user by the attendant, always operated with the user sited in the wheelchair.



It is recommended that this operation be performed only by the attendant. Always make sure that the backrest is locked in place to ensure perfect safety for the user. Keep away fingers from moving parts (levers, cylinders, mechanisms, etc.) to prevent injuries !

Avoid operating levers (A) (photo 6A) during a sideways transfer, for example, in order to prevent destabilising the user's position ! To ensure safety for the user, when backrest is reclined, we recommend to use anti-tippers (available as an option).

▲ Maintenance of reclining backrest mechanism varies with use. Please contact your Dealer.

Based upon the development of your disability, you can choose an Action⁴ backrest that meets your needs. Please consult with your Dealer.



6

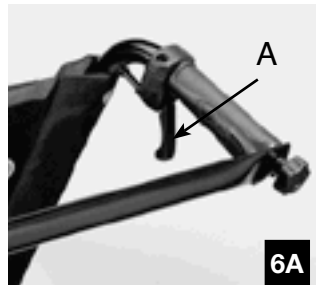

6A

2.1.3 Backrest upholstery

- Standard upholstery backrests

▲ In the event that the upholstered backrest slackens, ask for a replacement from your Dealer.

- Tension adjustable backrest (photo 7) it allows adjustment of the backrest curvature based upon user's body posture. Lift the flap (A) and pull the straps (B) in order to stretch or slacken them. Each strap can be adjusted separately. Reposition the flap (A).



Check the quality and positioning of the Velcro fasteners. Always make this adjustment before the user settles down in the wheelchair to prevent injuries !

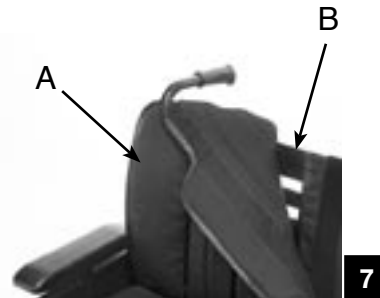

7

2.1.4 Hangers (Footrest supports) and footplates

- Standard footrest supports (photo 8) they swing away during transfers and can be removed during transport.

Operate lever (A) by pushing sideways and swivelling towards outside or inside in case there is not enough space. To return to the initial position, align the footrest support it locks automatically.

To remove the footrest support, simply pull up after unlocking the assembly. Reverse the procedure to reassemble, while still in the unlocked position.

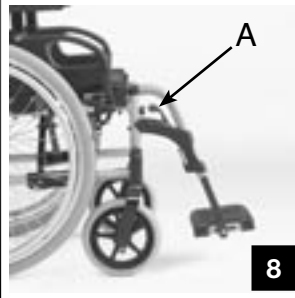

- Legrest (photo 9 & 10) performs the same operation as for the footrest support to swing away or remove the legrest, by operating lever (A) which unlocks the locking system.

To adjust the angle, support the leg with one hand while loosening the locking knob (B) with the other hand. Lift or lower the legrest in the desired position and firmly tighten the knob (B).

The calfpad swings away during transfers and is height adjustable by sliding. After loosening the screw (C), adjust to the desired height and firmly tighten the screw (C). In addition, it is depth adjustable loosen the screw (D), bring to new position and firmly tighten the screw (D).

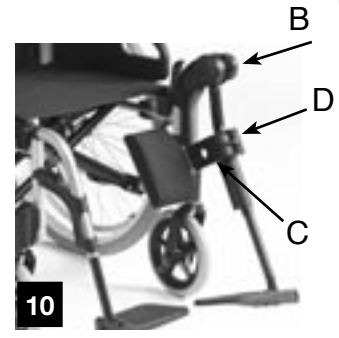

- Footrests (photo 11 & 12) : the footplate can be lifted during transfers footrests are height adjustable and can be equipped with a fixed or articulated footplate (optional). Loosen the screw (A) to adjust to the desired height, firmly tighten the screw after adjustment.

The footplate can be articulated by indexed plate (optional) loosen the screw (B), adjust to the desired angle and tighten securely.

- Straps : to ensure a good position of the feet, two types of straps can be provided; the heelrest strap (plain or adjustable by Velcro fasteners) and the calfpad strap attached to the footrest support are both adjustable by Velcro fasteners.

Note : the standard footrest supports and legrests are mounted in pairs on the wheelchair; whenever you remove them, remember that you have a right side and a left side !

 Never lift the wheelchair by the footrest supports or legrests !
Keep your fingers away from movable parts during folding, disassembling or adjustment to prevent injuries !

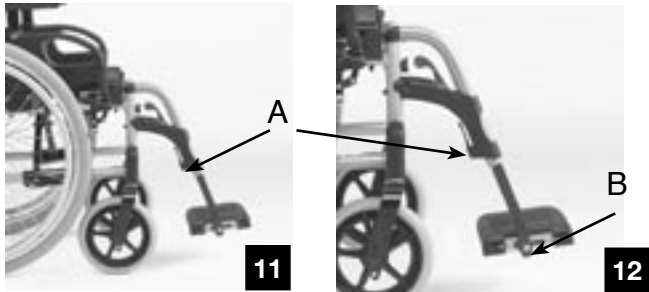

2.1.5 Armrests

- Removable simple n°1 (photo 13) : to remove armrests, simply pull them up. Previously, press on the push pin (D) located at the bottom of the armrest vertical upright. Reverse the procedure to reinstall them. To adjust their height (3 positions), remove the screw (A), adjust to the desired height and reposition the screw (A), tighten without forcing.

The armrests with central fixation (n°1 & n°4) from now on are equipped with a support adjustable (in 2 parts) which enables you to reduce the plays and to facilitate the vertical tube extraction, it is necessary to tighten or loosen the 4 screws (B) according to the anticipated result (photo 14).

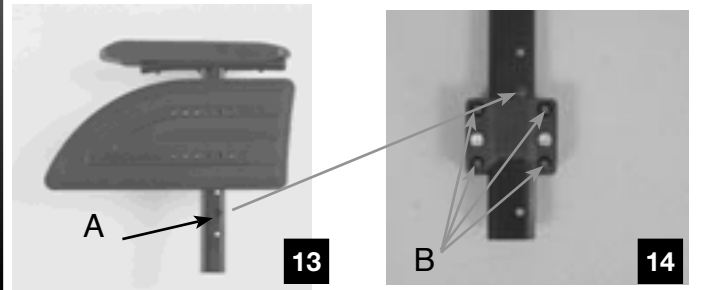

- Swing-away, removable n°2 (photo 16 and 17)

This range of armrests can be swung away to facilitate transfers and disassembling during transport.

To swing the armrest away, push down the dog point (A), reverse the procedure to reinsert making sure that the dog point (B) is properly engaged in its housing.

To remove the armrest, swing it back completely and pull it up. Reverse the procedure to reinstall.

The new design includes handle (C) and hollowed skirt-guard (D) to facilitate front transfer.

Grip firmly the armrest handle, take care of your nails on the skirt-guard edges.

Push on your arms to easily lift yourself up and the attendant can help you to finalise the transfer to the place where you wish to sit.

In the event the armrest handle covers (C) become slippery, it is recommended to request your dealer to replace them.

 refer to paragraph 1.2.2. *Front transfert* for safety instructions.

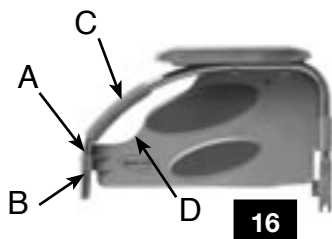

16



17

• Adjustable monobloc n°5 (photo 18 and 19) : To swing the armrest away, activate the grey trigger (A). To automatically reinsert it swing it down and make sure that the guide (B) is properly engaged in its housing.

To adjust the armpad in height and depth, slightly loosen the ball screw (C), adjust for the desired height based upon the preset holes and firmly tighten the screw ; slightly loosen the two screws (D) and slide the armrest down for the desired depth, firmly tighten the two screws (D).

Note : the armrests are mounted in pairs on the wheelchair; whenever you remove them, remember that you have a right and a left side !

 Never lift the wheelchair by the armrests !

Keep your fingers away from movable parts during folding, disassembling or adjustment to prevent injuries !

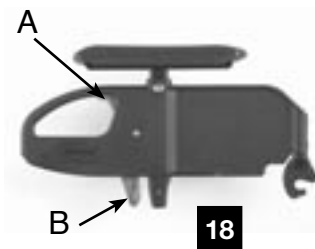

18

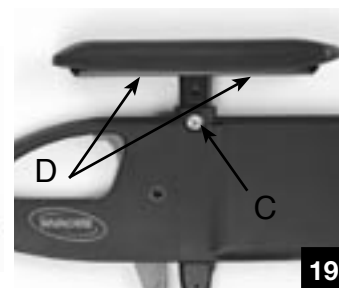

19

2.2 Frame

2.2.1 Sides

The sides or side frames are designed to accommodate the steering tubes for the castors and multiple adjustment wheel mounting for rear wheels.

These wheel mountings allow five height positions and two longitudinal positions (advanced for better handling or backward for better stability).

2.2.2 Double folding system

It consists of two double cross-bars which integrate the seat rails.

To fold and unfold your wheelchair, see chapter A “ General ” paragraph 2.1.

2.2.3 Steering tubes

They provide seat dump (0° , 3° or 6°) based upon user's capacity, propulsion, desired floor-to-seat height and selected front and rear wheels.

▲ All these adjustments and changes of position must be performed by a professional technician upon agreement by your prescribing physician. Please consult with your dealer.

2.3 Rear wheels

2.3.1 Wheels

The 24" (610 mm) and 22" (550 mm) wheels are only spoked wheels. They can be delivered with pneumatic or solid tyre.

A flat tyre (photo 20) must be removed in order to be repaired. Remove the rim assembly (tyre and inner tube), repair or replace the inner tube, reinsert in the tyre and reposition the assembly on the rim.

Comply with the inflation pressure specified on the sidewall of the tyre.

Note : remember that in order to maintain the interchangeability of the chair wheels equipped with quick-release axles, the pressure in the two tyres should be the same.



 Never exceed the pressure specified on the sidewalls of the tyre, otherwise, the tyre may explode and cause injuries !

▲ Pneumatic tyres wear out. In addition, the roughness of the ground surface and driving have an impact on their longevity. Replace them regularly to avoid trouble caused by puncture. Please consult with your Dealer.

2.3.2 Handrims

They provide the wheelchair propulsion. They can be made of anodized aluminium or coated with nonslip plastic (optional).

 Handrims are constantly in contact with your hands. Make sure that they are not damaged !



2.3.3 Axles

The axles connect the wheels and frame (photo 21). Fixed and quick-release axles are available

- Fixed axles: regularly check the axle tightening.

- Quick-release axles (photo 22) : depress the button (A) and insert the axle in the wheel hub. Position the assembly in the bearing (B) of the multiple adjustable wheel mounting until it locks in place. The locking balls (C) must rise above the bearing. No significant side clearance is allowed.

To reduce clearance as much as possible, remove the axle and adjust the nut using a 19 mm key ; then block the axle with an 11mm open-end key.

 Make sure that the axle and the locking balls are clean. To prevent falls, it is essential that the button (A) and the locking balls (C) are disengaged providing a perfect lock of the rear wheels. The quick release axle is a precision part, take care of shocks and clean regularly to ensure the good working of the mechanism.

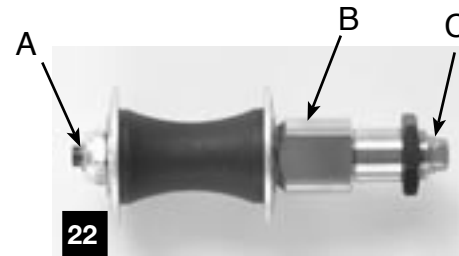

2.4 Castors

2.4.1 Wheels

The front wheels are available in 8" (200mm) diameter and in two widths, 1 3/8" (32 mm) and 2" (50mm), or in 6" (150mm) diameter and a single width of 1 3/8" (32mm). They can be delivered with pneumatic or solid tyre.

A 5" (100 mm) diameter soft roll (medium hard) is available.

Note : refer to paragraph 2.3.1. for regular maintenance.

2.4.2 Forks

Different fork positions are available based upon the selection of floor-to-seat height, castors and rear wheels.

▲ Please take advice from your dealer, if you want to replace or remove the castors or rear wheels.

2.5 Brakes

2.5.1 Manual brakes

The manual brakes (photo 23) are designed to secure the

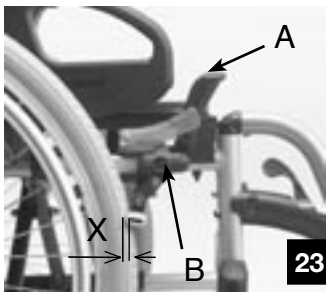

wheelchair during long stops. They are not intended to slow down the wheelchair or to be used as support during a transfer.

They must be operated simultaneously.

In order to brake, push the handle (A) forward. The handle folds back to facilitate transfers. Draw as a preliminary the handle upwards ! Once the brakes are engaged, the wheelchair should not move at all.

Note : brakes adjustments are based upon the diameter and type of the wheels.

After repairing a flat tyre or in the event of wear of the pneumatic or solid tyre, you may need to adjust the brake(s).

To adjust the brake(s), loosen the two screws (B) and slide the brake assembly to obtain the following value between the wheel and the brake shoe in unlocked position :

Solid tyre X = 6 mm, Pneumatic tyre X = 5 mm



Firmly tighten the screws (B) after adjustment. Keep your fingers away from movable parts to prevent injuries !

2.5.2 Hub brakes

Besides the functions provided by manual brakes, the hub brakes provide the slow down (for example, on a slope) and improved safety because they are still efficient when you have a flat tyre !

Two versions are available: (photos 24 and 25) attendant control and dual control (attendant and user).

To slow down, gradually pull the lever (A) upwards.

To lock the brake in parking position, with the lever (A) tightened, push the lock (B) to engage it in the notches of the brake handle ; then pull the lock up to unlock.

To adjust braking : turn the screw (C) counterclockwise to increase braking force and turn clockwise to reduce it.

▲ The specific adjustments of hub brakes must always be performed by your Dealer.

⚠ Always operate the two brakes simultaneously and do not take slopes exceeding 5% to ensure perfect control of the wheelchair steering !

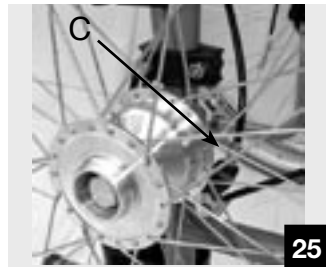
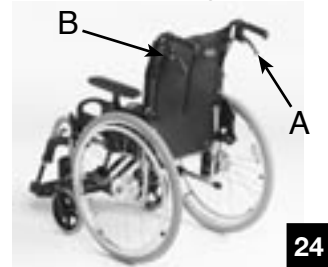

2.6. Options

2.6.1 Seating options

- Back brace (photo 26) : it provides tension to the backrest upholstery and provides the attendant better ergonomics when pushing the wheelchair.

Note : it swings away to facilitate the wheelchair folding; slightly loosen the button (A), pull up and swivel along the backrest until it is in vertical position.

To reposition it, reverse the procedure and firmly tighten the button (A) making sure that the button is properly tighten (B).

- Swing away back brace (photo 27) : Press the push pin (C) and fold down the back brace. Reverse the procedure to reinstall. Note that the push pin (C) should be locked in its hole.

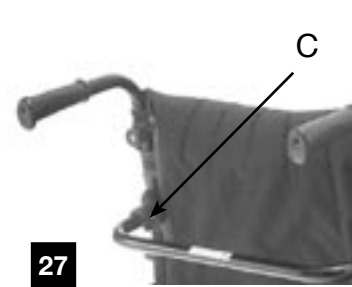
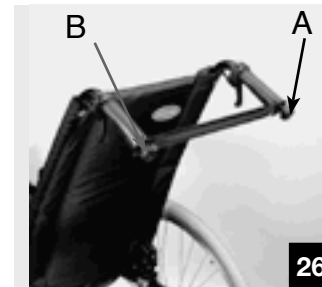

 Do not lift the chair by handling the back brace. There is a risk to unlocked the back brace by push it up. Keep your fingers away from movable parts to prevent injuries.

2.6.2 Propulsion options

- Transit version (photo 28) : the wheelchair is designed to be driven only by the attendant. To facilitate sideways transfers and save space, the wheelchair is equipped with rear wheels of 12" (315 mm) with pneumatic or solid tyre.

The manual brakes (optional hub brake) are only accessible to the attendant; operate the handle (A) to lock the wheelchair in parking position.

Note : for further information about the use of the two types of brakes, see paragraphs 2.5.1 & 2.5.2.



28

2.6.3 Safety options

- Pelvic belt

- Velcro fastener (photo 29) : position the two Velcro strips one over the other based upon the user's build.
- Buckle fastener (photo 30) : to close the buckle, engage part (A) into part (B), to open press (C).

Straps should be adjusted to suit user, insert into part (B) of the buckle and adjust the loop (D) based on the remaining length.

 The belt fixing should be conform to the scheme enclosed with each belt delivery; the belt should be mounted and adjusted by your regular dealer.

Make sure that the belts do not get caught in the spokes of the rear wheel.

The pelvic belt must not be used as safety belt in a car.



29

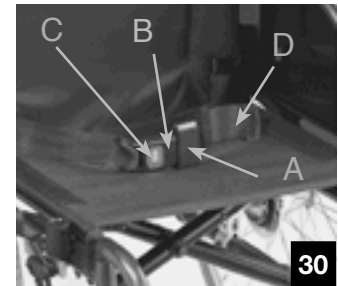

30

- Anti-tippers with tipping lever (photo 31) : prevent back tipping which ensures safety when using a reclining backrest, driving on slopes or crossing obstacles.

It is height adjustable and also act as tipping lever (see paragraph Tipping lever)

Anti-tippers can remain in place when the wheelchair is not used; perform a half-turn by activating the button (A schema 32) to its indexing.

 The recommended distance between anti-tippers small wheels and floor is 3 to 5 centimetres ; this adjustment is required with reference to the position and diameter of the rear wheel.

Push down the button (A schema 32) and adjust the wheels holding tube for the desired distance based upon the preset holes.

 Make sure that the dog points come out of their positioning hole in order to prevent any falls.

- Tipping lever (photo 33) : it allows the attendant to easily tip the wheelchair when crossing an obstacle (pavement, step, etc.) ; push down the lever with your foot (right or left) and maintain balance using the push handles.

The tipping lever is mounted the same as the anti-tippers, in the same tube.

2.6.4. Transparent tray (photo 34) : it is positioned on the armpads of the armrests (full length ones only). Slide the tray forward or backward based upon the user's build.

 Do not place very heavy and instable objects, containers with very hot and corrosive liquids on the tray, which may cause serious injury if they fall.

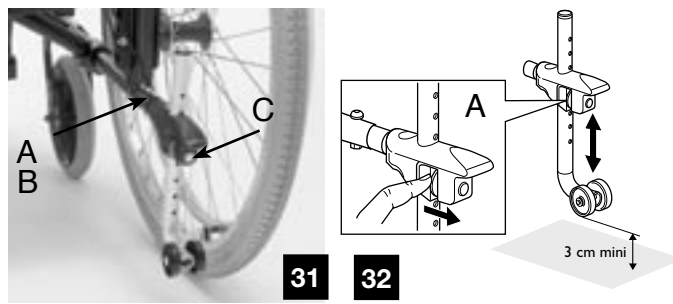

3. Specifications and tool

3.1. Standard wheelchair specifications

Maximum user weight :	125 kg (150 kg)
Seat width :	38/40.5/43/45,5/48 cm (50,5/55,5/60,5 cm)
Seat depth :	40/45 cm
Floor/seat height :	51/48.5/46/43.5/41/38,5 cm
Rear wheel :	24" (610 mm) pneumatic tyre
Castors :	8" (200 mm) solid tyre
Parking brake :	Manual brake with indexed brake shoe
Backrest :	Fixed, folding and reclining
Armrests :	Removable, removable and swing-away
Footrest supports & Legrests :	Removable and swing-away
Seat upholstery :	Black nylon on reinforced upholstery
Frame :	Aluminium, epoxy coated
Wheelchair average weight :	15 kg

3.2. Tools for adjustments and regular maintenance (not supplied)

Function	Tool
Brake	5 mm Allen key
Footrest tube	5 mm Allen key
Footplate	5 mm Allen key
Adjustable armrests n°5	5 mm Allen key
Simple armrests n°1	4 mm Allen key
	10 mm open-end wrench
Armpad	T20 Torx key
Castor	13 mm open-end Wrench(X 2)
Quick-release axle	19/27 mm open-end wrench
	11/19 mm open-end wrench

After sale and disposal recommendations

- It is compulsory to use original Invacare® spare parts which you can buy through any Invacare® dealer.
- For repair, please contact your local Invacare® dealer.
- Disposal : the metal parts can be disposed of for scrap metal through recycling. Plastic parts are disposed of as plastic scrap metal. Plastic parts are disposed of as plastic scrap. Disposal must be carried out in accordance with the respective national regulation. Please apply to your municipal authorities/local government for details about local disposal companies.

3.3. Dimensions

Picture	Description	Min/Max value	Picture	Description	Min/Max value
	Seat effective width (mm)	380/605		Backrest height including headrest (mm)	1045/1290
	Overall width (mm)	590/815		Overall length (mm)	1050/1110
	Width of folded wheelchair (mm)	305		Length without footrest (mm)	830/900
	Total height (mm)	900/1030		Distance between front wheel and rear wheel (mm)	390/550
	Height from ground to back seat (mm)	360/510		Backrest angle (°)	0/30
	Height from ground to front seat (mm)	385/510		Bracket angle (°)	80
	Backrest height (mm)	380/510		Distance between footrest and seat (mm)	350/480
	Wheelchair height when backrest is folded (mm)	N/A		Distance between armrest and backrest (mm)	250/350

Picture	Description	Min/Max value	Picture	Description	Min/Max value
	Fixed armrest height (mm)	200/260		Maximum obstacle height (mm)	128
	Adjustable armrest height (mm)	190/295		Maximum down slope (0°)	21
	Notched armrest height (mm)	130		Maximum up slope (0°)	18
	Rear wheel diameter (mm)	560/610		Maximum lateral super elevation (0°)	18,5
	Handrim diameter (mm)	470/520		Removable parts	Wheels Armrests Footrests
	Seat plane angle (0°)	0/6		Overall weight when empty (kg)	15/15,5
	Height without rear wheel (mm)	605		User's maximum weight (kg)	125 150
	Turning circle (mm)	850		Weight of the heaviest removed part (kg)	9
	Cushion depth (mm)	50		Seat material Fire class	Nylon:M4 NF EN 1021-1 NF EN 1021-2



Yes, you can.

Invacare® France Operations SAS

Route de Saint Roch

37230 FONDETTES

Invacare® n.v.

Autobaan 22 8210 Loppem (Brugge) **Belgium** ☎ +32 (50) 831010 **Fax** +32 (50) 831011

Invacare® A/S

Sdr. Ringvej 39 2605 Brøndby **Danmark** ☎ (kundeservice) +45 - (0) 3690 0000 **Fax** (kundeservice) +45 - (0) 3690 0001

Invacare® Deutschland GmbH

Kleislstraße 49 32457 Porta Westfalica **Deutschland**

☎ (Technische Hotline) 01 80 - 5 26 22 64 **Fax** (Technische Hotline) 01 80-5 26 22 75

Invacare® SA

c/Areny s/n Poligon Industrial de Celrà 17460 Celrà (Girona) **España** ☎ +34 - (0) 972 - 49 32 00 **Fax** +34 - (0) 972 - 49 32 20

Invacare® Poirier SAS

Route de St Roch F-37230 Fondettes **France** ☎ +33 - (0) 2 47 62 64 66 **Fax** +33 - (0) 2 47 42 12 24

Invacare® Mecc San s.r.l.

Via dei Pini, 62 I-36016 Thiene (VI) **Italia** ☎ +39 - (0) 445-380059 **Fax** +39 - (0) 445-380034

Invacare® AS

Grensesvingen 9 0603 Oslo **Norge** ☎ (kundeservice) +47 - 22 57 95 10 **Fax** (kundeservice) +47 - 22 57 95 01

Invacare® PORTUGAL Lda

Rua Senhora de Campanhã 105 4369-001 Porto **Portugal** ☎ +351-225105946 **Fax** +351-225105739

Invacare® AB

Fagerstagatan 9 163 91 Spånga **Sverige** ☎ (kundtjänst) +46 - (0) 8 761 70 90 **Fax** (kundtjänst) +46 - (0) 8 761 81 08

Invacare® B.V.

Celsiusstraat 46 NL-6716 BZ Ede **The Nederland** ☎ +31 - (0) 318 - 69 57 57 **Fax** +31 - (0) 318 - 69 57 58

Invacare® Ltd

South Road Bridgend Mid Glamorgan CF31 3PY **United Kingdom**

☎ (Customer Service) +44 - (0) 1656 - 647 327 **Fax** (Customer Service) +44 - (0) 1656 - 649 016



AC4-G-01 UK V2
04/2006