

New products  
added



 MADE IN THE  
 NETHERLANDS

relief by air





## Lifetime warranty is a unique Vicair service that applies to the latest generation of Vicair SmartCells.

We stand for the quality of these cells and therefore will always replace them in case some of them unexpectedly do not last a lifetime. Vicair Lifetime Warranty is an off-the-shelf service, no registration necessary. You can recognize the latest generation SmartCells by their black Vicair logo-print.

relief by air

# CONTENTS

## VICAIR IS FOR EVERYBODY AND EVERY BODY

**Vicair is for everyone.** We are always striving to provide wheelchair users of all shapes, ages and sizes the best possible seating solution by offering versatile standard cushion models, each of which can be adjusted to more specific individual needs.

When faced with a seating challenge that requires more than an adjusted standard model, the Vicair Technology allows us to create the most uniquely shaped wheelchair seating solutions.

**This is why Vicair cushions are the very best at safeguarding the three most important pillars of seating and positioning in wheelchairs:**

- **High quality skin protection**  
Redistributing pressure, minimizing shear forces and controlling microclimate.
- **Providing optimal postural support**  
Stabilizing the sitting posture, contouring and adjusting to the user's body.
- **User friendly**  
Extremely lightweight, ready for use and easy to maintain and wash.

As we've done since 1993, we will continue to provide the best possible individual seating solution to whomever is in need. Whether that solution comes in the shape of a standard product or in a shape that is especially designed and created to exactly fit the most unique body contours.

For us it is all about making a positive difference in the daily life of wheelchair users. To do this we will always make sure that Vicair products are the perfect fit for Everybody and Every Body. Now and in the future.

**That's why Vicair is the Perfect Package.**

Vicair technology .....	4
-------------------------	---

Cushion sizes.....	5
--------------------	---

### Vicair O2 seat cushions

Vicair Adjuster O2 .....	7
Vicair Vector O2 .....	8
Vicair Active O2 .....	9
Vicair AllRounder O2 .....	11
Vicair Adjuster 12 O2 .....	12
Vicair XXtra O2 .....	13
Vicair Centre Relief O2 .....	14
Vicair Multifunctional O2 .....	15
Vicair Pommel cushion O2 .....	16
Vicair Junior Vector O2 .....	17

### Cushion covers

Vicair O2 Top Cover .....	19
Vicair Comfair Cover.....	20
Vicair Incotec Cover.....	20
Vicair Reversible Cover .....	21
Vicair Air Exchange Cover .....	21

### Liberty seat cushions

Vicair Liberty .....	23
Vicair Liberty Profile.....	24
Vicair Liberty TC.....	25

### Vicair seat cushions

Vicair 4 .....	27
----------------	----

### Back cushions

Vicair Multifunctional back O2.....	29
Vicair Anatomic back .....	30
Vicair Liberty back .....	31
Vicair Strap back.....	32
Vicair Back Connector .....	32

### Mattresses

Vicair Mattress 415 .....	33
Custom Made.....	35
Quality, Warranty, ISO and MDR .....	35

# VICAIR TECHNOLOGY



The best medium for pressure redistribution is air. Unfortunately, there are a few drawbacks; air is unstable and it tends to leak. Vicair solved these issues when they created Vicair SmartCells.

The unique Vicair air-technology, which uses the small air-filled SmartCells, was developed in cooperation with the Amsterdam Rehabilitation Centre. It was awarded the Grand Prix at the 'Salon des Inventions' in Geneva, Switzerland. Vicair develops and produces its product line in the Netherlands for customers all over the world.

*Relief by Air: How does it work?*

Vicair products are designed for **high-performance skin protection, for optimal postural support and to be user-friendly**. When you sit on a Vicair wheelchair cushion, you are supported by hundreds of air-filled SmartCells. SmartCells contain a sealed volume of air, redistributing forces evenly and **minimizing peak pressures** in high risk areas. SmartCells will deform and move when loaded, which **enables immersion, envelopment and limits shear and friction forces on the skin**. All important factors that facilitate skin protection.



**High performance skin protection**  
*Redistributing forces evenly, minimizing peak pressures, immersion, envelopment, limiting shear and friction forces, and microclimate control.*

Temperature and humidity at the skin's surface – also known as microclimate – also influence the skin's integrity.



Uncontrolled microclimate forms an indirect risk for developing pressure injuries. For optimal protection it is recommended to keep the skin dry and cool. Therefore **Vicair O2 products are made of perforated material** and have an open mesh bottom. This allows excess moisture to drain away from the skin and air to flow so heat build-up is decreased.

**Optimal postural support**  
*Stabilizing and adapting to postural changes, multicompartment design that matches anatomical shape of the body's surface.*

Each Vicair cushion has a unique multicompartment design that matches the shape of the body's surface, each compartment has an optimized SmartCell filling. **Adapting to postural changes** occurs through a combination of movements and deformation of the SmartCells. The SmartCells move inside the cushion compartments with so little friction that they resemble the behaviour of a viscous fluid, hence the name Vicair – Viscous Air. The SmartCell size in combination with the size of the compartment will influence the degree of movement of the cells.



# CUSHION SIZE

The amount of SmartCells in every compartment is optimized to provide an optimal degree of firmness for the corresponding body surface. **Creating a unique combination of skin protection and postural stability.**

## User friendly

*Ready for use, lightweight, safe over time and fully machine washable.*

For most wheelchair users a Vicair cushion is **ready to use straight out of box**. In case of specific needs the filling grade of each compartment can be easily adjusted, even whilst the cushion is being sat on. Vicair wheelchair cushions are **safe to use over time**: hundreds of SmartCells create several layers between the user's body surface and the base under the Vicair product. Making Vicair products safe to use, even in the unlikely event of failure of some SmartCells. That's why **no daily checks are required** and in case of an unfortunate SmartCell failing we offer **lifetime warranty on the latest generation of SmartCells**. Furthermore, Vicair O2 products can be **machine washed in their entirety**, SmartCells remaining inside the compartments, for easy cleaning whilst any adjustments to your set-up are maintained. Last but not least, Vicair wheelchair cushions are **extremely lightweight**, making them easy to transport during transfers and no heavy burden for the wheelchair users that roll around with them all day.

**It's not only the unique technique of the Vicair cushions that provides an optimal seating position. Next to the seat cushion a proper set-up of the wheelchair is extremely important.**

Think of the adjustment of the foot plate, correct seating angle, right back support height, but also the seat to floor height.

To get the correct size of wheelchair cushion, Vicair recommends to measure as follows:

The width (X) of the cushion and the wheelchair seat should match. When the cushion rests against arm support or side-guards, the width of a Vicair seat cushion may be up to 2,5 cm (1") wider.\* The depth (Y) of the cushion and seat should match.

When ordering a Vicair cushion, first mention the width (X) of the cushion and then the depth (Y).

\* Exception: The width of the Vicair Active O2 should always match the width of the wheelchair seat.

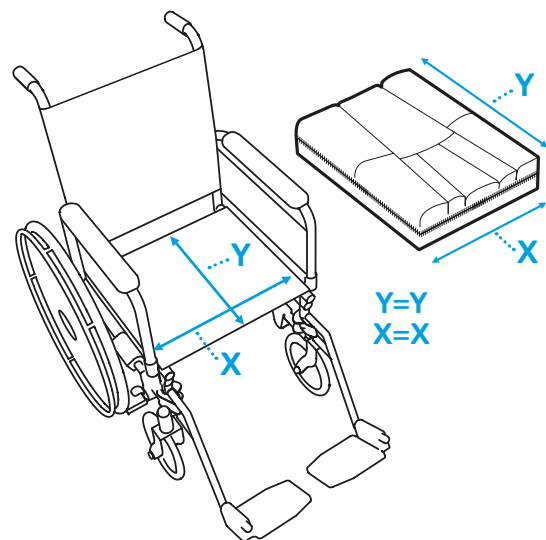



# VICAIR<sup>®</sup>

# O2

The Vicair O2 cushions tackle the hygiene issues caused by incontinence. The open structure of the Vicair O2 cushions allows the cushions to be easily washed in any washing machine. Without the need for a laundry bag, and without removing the SmartCells. These cushions are ideal for both institutional and home use, in situations where incontinence, temperature and humidity is an issue.

## Highest level of skin protection

## Exceptional stability & positioning

## Easy to maintain; no inflation necessary



**100% MACHINE WASHABLE**  
The cushion is, with the SmartCells inside, fully machine washable at 60°C.

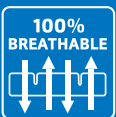

**100% BREATHABLE**  
The open structure of the cushion provides optimal temperature and moisture regulation.

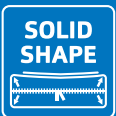

**SOLID SHAPE**  
New design ensures that the cushion keeps its shape and volume, resulting in improved support and skin protection.



**READY FOR USE**  
The standard filling ensures that for most wheelchair users the cushion is ready for use straight out of the box.



**PRESSURE INJURY TREATMENT PLAN**  
The cushion is a high quality addition to a pressure injury treatment plan (stage I-IV).

relief by air



THE OPTIMAL CUSHION FOR WHEELCHAIR USERS WITH BODY ASYMMETRY

Pre-ischial bar limits sliding forward | converts shear into normal forces

Follows the body's contours for equal pressure distribution | support IT-coccyx area | managing pelvic asymmetry



Thigh support

Mid height zip closure for easy adjustment when client is seated | cushion keeps its shape, enhancing the user's skin protection

- PRESSURE INJURY TREATMENT PLAN**
- 100% BREATHABLE**
- SOLID SHAPE**
- MACHINE WASHABLE**
- READY FOR USE**
- 145 STANDARD SIZES**

- ▲ Individual solution for asymmetry
- ▲ Minimizes sliding and shear forces
- ▲ Optimal adjustment to the body's contours for equal pressure distribution

The Vicair Adjuster 02 consists of 5 individual compartments, designed to contour under loading. Each compartment is designed to influence a specific area of the pelvis, striking a unique balance between preserving skin and underlying tissue at the ischials, coccyx and trochanters, positioning the pelvis and supporting the femurs. For specific needs the filling of each of the 5 compartments can be easily adjusted. Allowing you to change the density of each compartment benefitting users who: (1) need accommodation of a mild to severe fixed pelvic obliquity or correction of a flexible pelvic obliquity; (2) benefit from additional support of the thighs, for instance users with an above knee amputation.

**AVAILABLE COVERS**  
Vicair 02 Top Cover, Comfair Cover, Incotec Cover and Reversible Cover.

PRODUCT PERFORMANCE	
<b>Skin protection / Anti decubitus</b>	
Pressure redistribution	▲▲▲▲▲
Shear force reduction	▲▲▲▲▲
Microclimate control	▲▲▲▲▲
Impact & vibration damping	▲▲▲▲▲
<b>Positioning</b>	
Lateral stability	▲▲▲▲△
Frontal stability	▲▲▲▲▲
Sliding reduction	▲▲▲▲▲
Allows manual adjustments	▲▲▲▲▲
Increasing endurance	▲▲▲▲△
<b>Maintenance &amp; Safety</b>	
Durability	▲▲▲▲▲
Reliability	▲▲▲▲▲
Functionality when misused	▲▲▲▲△
Easy to maintain	▲▲▲▲▲
Level of hygiene	▲▲▲▲▲
<b>Functionality &amp; Application</b>	
Comfort	▲▲▲▲▲
Ultra light weight	▲▲▲▲▲
Allows easy transfers	▲▲▲△△
Available standard sizes	▲▲▲▲▲
Maximum user weight	▲▲▲▲△

TECHNICAL SPECIFICATIONS	
Thickness	6 and 10
Average weight	725 grams
Max. user weight	250 kg
Machine washable	60°C max.

**CUSHION SIZES**  
■ Standard (Sizes >53 cm thickness 10 only)  
■ On request

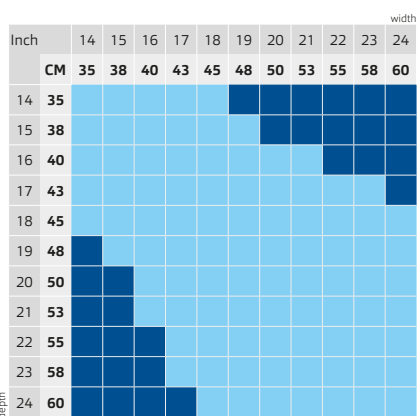

## THE MOST STABLE CUSHION FOR WHEELCHAIR USERS

**Ischial well - Two compartments**  
for superior pressure reduction in the IT-coccyx area & extra positioning possibilities

**Trochanter support**  
firmer density to provide lateral stability | redistributes pressure to help create an ischial well

**Front compartments** provide leg alignment and stability | easily adjustable for individual positioning needs

**Mid height zip closure** for easy adjustment when client is seated | cushion keeps its shape, enhancing the user's skin protection



- PRESSURE INJURY TREATMENT PLAN**
- 100% BREATHABLE**
- SOLID SHAPE**
- MACHINE WASHABLE**
- READY FOR USE**
- 145 STANDARD SIZES**

- ▲ **Nine adjustable compartments for optimal stability**
- ▲ **Expanding the user's reach**
- ▲ **Extra positioning of the thighs**

The Vicair Vector 02 is a pre-contoured cushion which consists of 9 individual compartments. Each compartment is designed to influence a specific area of the pelvis, striking a unique balance between preserving skin at the ischials and coccyx by re-distributing pressures, stabilizing the pelvis and positioning of the femurs. For specific needs the filling of each of the 9 compartments can be easily adjusted. Allowing you to change the density of each compartment benefitting users who: (1) Need correction or accommodation of an asymmetric pelvis. (2) Want (partial) off-loading of the ischial and coccyx area. (3) Need correction or accommodation for better thigh alignment. (e.g. abduction, one side foot propulsion, opening pelvic thigh angle).

### AVAILABLE COVERS

Vicair 02 Top Cover, Comfair Cover, Incotec Cover and Reversible Cover.

### PRODUCT PERFORMANCE

Skin protection / Anti decubitus	
Pressure redistribution	▲▲▲▲▲
Shear force reduction	▲▲▲▲▲
Microclimate control	▲▲▲▲▲
Impact & vibration damping	▲▲▲▲▲
Positioning	
Lateral stability	▲▲▲▲▲
Frontal stability	▲▲▲▲▲
Sliding reduction	▲▲▲▲▲
Allows manual adjustments	▲▲▲▲▲
Increasing endurance	▲▲▲▲▲
Maintenance & Safety	
Durability	▲▲▲▲▲
Reliability	▲▲▲▲▲
Functionality when misused	▲▲▲▲△
Easy to maintain	▲▲▲▲▲
Level of hygiene	▲▲▲▲▲
Functionality & Application	
Comfort	▲▲▲▲▲
Ultra light weight	▲▲▲▲▲
Allows easy transfers	▲▲▲▲△
Available standard sizes	▲▲▲▲▲
Maximum user weight	▲▲▲▲△

### TECHNICAL SPECIFICATIONS

Thickness	6 and 10 cm
Average weight	725 grams
Max. user weight	250 kg
Machine washable	60°C max.

### CUSHION SIZES

- Standard (Sizes >53 cm thickness 10 only)
- On request

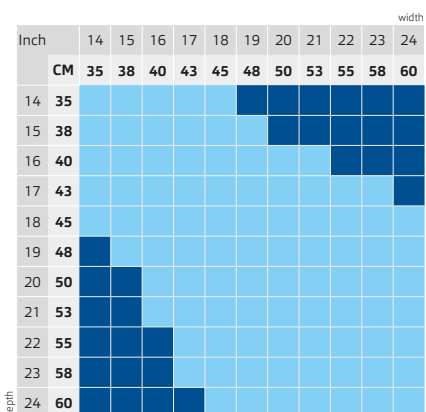



## FOR THE ACTIVE WHEELCHAIR USER

**Ischial well - Two compartments**  
for superior pressure reduction in the IT-coccyx area & extra positioning possibilities

**Trochanter support**  
firmer density to provide lateral stability | redistributes pressure to help create an ischial well

**Ergonomically-shaped foam**  
for easy transfers

**SmartCell – Foam barrier**  
limits sliding forward

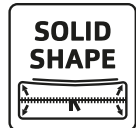
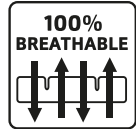

- ▲ Perfect for users who transfer frequently
- ▲ Excellent lateral and frontal stability
- ▲ Features a nifty storage pouch for personal items



The Vicair Active 02 is a pre-contoured cushion which consists of 4 individual compartments filled with Smartcells at the back of the cushion and an anatomically contoured foam inlay at the front. Striking a unique balance between preserving skin at high risk areas at the ischials and coccyx by redistribution of pressures, stabilizing the pelvis and facilitating easy transfers. For specific needs the filling of each of the 4 SmartCell filled compartments can be easily adjusted. Allowing you to change the density of each compartment benefitting users who: (1) Need correction or accommodation of an assymetric pelvis. (2) Want (partial) off-loading of the ischial and coccyx area. (3) Benefit from additional lateral support.

### PRODUCT PERFORMANCE

#### Skin protection / Anti decubitus

Pressure redistribution	▲▲▲▲△
Shear force reduction	▲▲▲▲△
Microclimate control	▲▲▲▲△
Impact & vibration damping	▲▲▲▲△

#### Positioning

Lateral stability	▲▲▲▲▲
Frontal stability	▲▲▲▲▲
Sliding reduction	▲▲▲▲▲
Allows manual adjustments	▲▲▲▲△

#### Maintenance & Safety

Durability	▲▲▲▲▲
Reliability	▲▲▲▲▲
Functionality when misused	▲▲△△△
Easy to maintain	▲▲▲▲△
Level of hygiene	▲▲▲▲△

#### Functionality & Application

Comfort	▲▲▲▲▲
Ultra light weight	▲▲▲▲△
Allows easy transfers	▲▲▲▲▲
Available standard sizes	▲▲▲▲▲
Maximum user weight	▲▲▲▲△

### TECHNICAL SPECIFICATIONS

Thickness	6 and 9 cm
Average weight	1250 grams
Max. user weight	200 kg
Machine washable	60°C (without foam)

### CUSHION SIZES

- Standard (Sizes >53 cm thickness 9 only)
- On request

Inch	width										
	14	15	16	17	18	19	20	21	22	23	24
CM	35	38	40	43	45	48	50	53	55	58	60
14	35										
15	38										
16	40										
17	43										
18	45										
19	48										
20	50										
21	53										
22	55										
23	58										
24	60										

### AVAILABLE COVERS

Not applicable. The Vicair Active 02 only has one cover serving as inner and outer cover.

**FOLLOW US ONLINE**



EXPLORE YOUR POSSIBILITIES



- ▲ Stays with you during activities
- ▲ Skin protection outside the wheelchair
- ▲ Extremely light to support optimal mobility

The Vicair AllRounder O2 is a cushion that is strapped on to your body. It provides a moderate level of skin protection for individuals who are at risk of developing pressure injuries.

This occasional use activity cushion is used to provide comfort and prevent pressure injuries in situations outside the wheelchair. The Vicair AllRounder O2 consists of 5 individual compartments, designed to contour under loading. Each compartment is designed to influence a specific area of the pelvis. The standard filling of the AllRounder O2 is ready to use out of the box and fits most users who: play/sit on the ground, practice sports outside of their wheelchair, like gardening, go up and down stairs and use it during redecorating/refurbishing etc.

PRODUCT PERFORMANCE	
<b>Skin protection / Anti decubitus</b>	
Pressure redistribution	▲▲▲▲△
Shear force reduction	△△△△△
Microclimate control	▲▲▲▲△
Impact & vibration damping	▲▲▲▲△
<b>Positioning</b>	
Lateral stability	N/A
Frontal stability	N/A
Sliding reduction	N/A
Allows manual adjustments	N/A
Increasing endurance	N/A
<b>Maintenance &amp; Safety</b>	
Durability	▲▲▲▲▲
Reliability	▲▲▲▲▲
Functionality when misused	▲▲△△△
Easy to maintain	▲▲▲▲△
Level of hygiene	▲▲▲▲△
<b>Functionality &amp; Application</b>	
Comfort	▲▲▲▲▲
Ultra light weight	▲▲▲▲▲
Allows easy transfers	▲▲▲△△
Available standard sizes	▲▲▲▲▲
Maximum user weight	▲▲▲▲△

TECHNICAL SPECIFICATIONS	
Thickness	N/A
Average weight	800 grams
Max. user weight	100 kg
Machine washable	60°C max.

CUSHION SIZE	
Small	< 38 cm
Medium	38 – 42,5 cm
Large	43 – 48 cm

**Determining the correct hip width**  
 Measure the width of your hips to check which size matches the size of your body. When seated, hold a tape measure horizontally above the widest point of your upper legs, closely against the front of your hips. Do not follow your leg contours, keep the tape measure straight. Measure from A to B (or B to A). Choose the larger size if the measured size is in between two sizes.

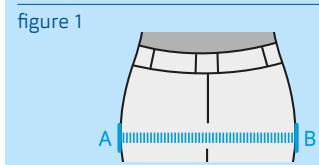



OPTIMAL CUSHION FOR POSITIONING

Follows the body's contours

for equal pressure distribution | support IT-coccyx area | managing pelvic asymmetry

Pre-ischial bar limits sliding forward | converts shear into normal forces



Mid height zip closure for easy adjustment when clients are seated | cushion keeps its shape, enhancing the user's skin protection

Thigh support

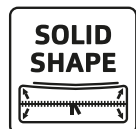
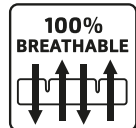

- ▲ Minimizes sliding and shear forces
- ▲ Individual solution for asymmetry
- ▲ Optimal adjustment to the body's contours for equal pressure distribution

The Vicair Adjuster 12 02 consists of 6 individual compartments, designed to contour under loading. It automatically manages obliquities and is individually adjustable to support more extreme asymmetry. The thickness of the cushion ensures perfect positioning. Each compartment is designed to influence a specific area of the pelvis, striking a unique balance between preserving skin and underlying tissue at the ischials, coccyx and trochanters, positioning the pelvis and supporting the femurs. For specific needs the filling of each of the 6 compartments can be easily adjusted, allowing you to change the density of each compartment.

PRODUCT PERFORMANCE

Skin protection / Anti decubitus

Pressure redistribution	▲▲▲▲▲
Shear force reduction	▲▲▲▲▲
Microclimate control	▲▲▲▲▲
Impact & vibration damping	▲▲▲▲▲

Positioning

Lateral stability	▲▲▲▲△
Frontal stability	▲▲▲▲▲
Sliding reduction	▲▲▲▲▲
Allows manual adjustments	▲▲▲▲▲
Increasing endurance	▲▲▲▲△

Maintenance & Safety

Durability	▲▲▲▲▲
Reliability	▲▲▲▲▲
Functionality when misused	▲▲▲▲△
Easy to maintain	▲▲▲▲▲
Level of hygiene	▲▲▲▲▲

Functionality & Application

Comfort	▲▲▲▲▲
Ultra light weight	▲▲▲▲▲
Allows easy transfers	▲▲△△△
Available standard sizes	▲▲▲▲▲
Maximum user weight	▲▲▲▲△

TECHNICAL SPECIFICATIONS

Thickness	12 cm
Average weight	900 grams
Max. user weight	250 kg
Machine washable	60°C max.

CUSHION SIZES

- Standard
- Special Size
- Custom Size

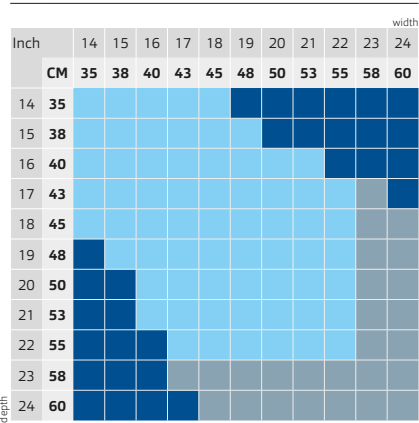

AVAILABLE COVERS

Vicair O2 Top Cover, Comfair Cover, Incotec Cover and Reversible Cover.

ESPECIALLY DEVELOPED FOR BARIATRICS

Pre-ischial bar limits sliding forward | converts shear into normal forces

Follows the body's contours for equal pressure distribution | support IT-coccyx area | managing pelvic asymmetry

Thigh support

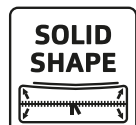
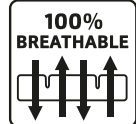

- ▲ User weight up to 500kg
- ▲ Shaped like the Vicair Adjuster 02
- ▲ Wider size range than other Vicair products

The Vicair XXtra 02 consists of 5 individual compartments, designed to contour under loading and contains especially designed – large – SmartCells to be able to support bariatric individuals. Each compartment is designed to influence a specific area of the pelvis, striking a unique balance between preserving skin and underlying tissue at the ischials, coccyx and trochanters, positioning the pelvis and supporting the femurs. The wheelchair cushion is able to support a body weight up to 500KG. For specific needs the filling of each of the 5 compartments can be easily adjusted, allowing you to change the density of each compartment.

**PRODUCT PERFORMANCE**

**Skin protection / Anti decubitus**

Pressure redistribution	▲▲▲▲▲
Shear force reduction	▲▲▲▲▲
Microclimate control	▲▲▲▲▲
Impact & vibration damping	▲▲▲▲▲

**Positioning**

Lateral stability	▲▲▲▲△
Frontal stability	▲▲▲▲▲
Sliding reduction	▲▲▲▲▲
Allows manual adjustments	▲▲▲▲▲
Increasing endurance	▲▲▲▲△

**Maintenance & Safety**

Durability	▲▲▲▲▲
Reliability	▲▲▲▲▲
Functionality when misused	▲▲▲▲△
Easy to maintain	▲▲▲▲▲
Level of hygiene	▲▲▲▲▲

**Functionality & Application**

Comfort	▲▲▲▲▲
Ultra light weight	▲▲▲▲▲
Allows easy transfers	▲▲▲△△
Available standard sizes	▲▲▲▲△
Maximum user weight	▲▲▲▲▲

**TECHNICAL SPECIFICATIONS**

Thickness	10 cm
Average weight	900 grams
Max. user weight	500 kg
Machine washable	60°C max.

**CUSHION SIZES**

- Standard
- On request

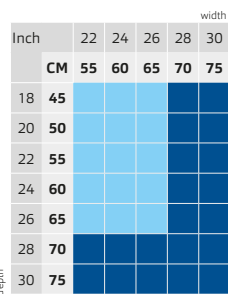

**AVAILABLE COVERS**

Vicair O2 Top Cover, Comfair Cover and Incotec Cover.

OFFLOADING PRESSURE IN THE HIGH RISK AREA



- ▲ For completely offloading of the rectal area
- ▲ Adjustable non-contact area
- ▲ Stable positioning

The Vicair Centre Relief 02 consists of 5 individual compartments, designed to contour under loading. Each compartment is designed to influence a specific area of the pelvis, striking a unique balance between preserving skin and underlying tissue at the ischials, coccyx and trochanters, positioning the pelvis and supporting the femurs. The unique feature is the circular compartment towards the rear of the cushion. Designed especially for (partial) offloading of the coccyx/rectal area. For specific needs the filling of each of the 5 compartments can be easily adjusted, for individuals who: (1) require (partial) offloading of the rectal area, (2) have coccyx problems, (3) have localized deep pressure injuries.

**PRODUCT PERFORMANCE**

**Skin protection / Anti decubitus**

Pressure redistribution	▲▲▲▲▲
Shear force reduction	▲▲▲▲△
Microclimate control	▲▲▲▲▲
Impact & vibration damping	▲▲▲▲▲

**Positioning**

Lateral stability	▲▲▲▲△
Frontal stability	▲▲▲▲▲
Sliding reduction	▲▲▲△△
Allows manual adjustments	▲▲▲▲▲
Increasing endurance	▲▲▲▲△

**Maintenance & Safety**

Durability	▲▲▲▲▲
Reliability	▲▲▲▲▲
Functionality when misused	▲▲▲△△
Easy to maintain	▲▲▲▲▲
Level of hygiene	▲▲▲▲▲

**Functionality & Application**

Comfort	▲▲▲▲▲
Ultra light weight	▲▲▲▲▲
Allows easy transfers	▲▲▲△△
Available standard sizes	▲▲▲△△
Maximum user weight	▲▲▲▲△

**TECHNICAL SPECIFICATIONS**

Thickness	10 cm
Average weight	750 grams
Max. user weight	250 kg
Machine washable	60°C max.

**CUSHION SIZES**

- Standard
- On request

Inch	width										
	14	15	16	17	18	19	20	21	22	23	24
CM	35	38	40	43	45	48	50	53	55	58	60
14	35	38	40	43	45	48	50	53	55	58	60
15	38	40	43	45	48	50	53	55	58	60	
16	40	43	45	48	50	53	55	58	60		
17	43	45	48	50	53	55	58	60			
18	45	48	50	53	55	58	60				
19	48	50	53	55	58	60					
20	50	53	55	58	60						
21	53	55	58	60							
22	55	58	60								
23	58	60									
24	60										

**AVAILABLE COVERS**

Vicair O2 Top Cover, Comfair Cover, Incotec Cover and Reversible Cover.



**COMFORT AND SKIN PROTECTION IN A TILT-IN-SPACE WHEELCHAIR**

Longer compartments to fit into tilt-in-space chairs | follow the body's contours for equal pressure distribution | support IT-coccyx area | managing pelvic asymmetry

Pre-ischial bar limits sliding forward | converts shear into normal forces

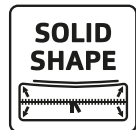
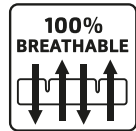

- ▲ Ideal for use in tilt-in-space chair with adjustable seat depth
- ▲ Vicair Adjuster O2 design with deeper rear end compartments
- ▲ Optimal adjustment to the body's contours for equal pressure distribution

The Vicair Multifunctional O2 consists of 5 individual compartments, designed to contour under loading. The cushion features a special 8 cm thick design with elongated rear end compartments for optimal use in tilt-in-space wheelchairs. 8 cm thickness is thick enough to protect the skin and low enough for optimal accessibility under tables, counter tops, desks etc. Each compartment is designed to influence a specific area of the pelvis, striking a unique balance between preserving skin and underlying tissue at the ischials, coccyx and trochanters, positioning the pelvis and supporting the femurs. For specific needs the filling of each of the 5 compartments can be easily adjusted, allowing you to change the density of each compartment.

**PRODUCT PERFORMANCE**

**Skin protection / Anti decubitus**

Pressure redistribution	▲▲▲▲▲
Shear force reduction	▲▲▲▲▲
Microclimate control	▲▲▲▲▲
Impact & vibration damping	▲▲▲▲▲

**Positioning**

Lateral stability	▲▲▲▲△
Frontal stability	▲▲▲▲▲
Sliding reduction	▲▲▲▲▲
Allows manual adjustments	▲▲▲▲▲
Increasing endurance	▲▲▲▲△

**Maintenance & Safety**

Durability	▲▲▲▲▲
Reliability	▲▲▲▲▲
Functionality when misused	▲▲▲▲△
Easy to maintain	▲▲▲▲▲
Level of hygiene	▲▲▲▲▲

**Functionality & Application**

Comfort	▲▲▲▲▲
Ultra light weight	▲▲▲▲▲
Allows easy transfers	▲▲▲▲△
Available standard sizes	▲▲▲▲△
Maximum user weight	▲▲▲▲△

**TECHNICAL SPECIFICATIONS**

Thickness	8 cm
Average weight	850 grams
Max. user weight	250 kg
Machine washable	60°C max.

**CUSHION SIZES**

cm	inches
37x52	14¾x20¾
40x52	16x20¾
45x52	18x20¾
50x52	20x20¾

Sizes in width x depth

**AVAILABLE COVERS**

Vicair O2 Top Cover, Comfair Cover and Incotec Cover.

**PRESSURE RELIEF AND STABILITY WITH A DETACHABLE POMMEL**

Follows the body's contours for equal pressure distribution | support IT-coccyx area | managing pelvic asymmetry

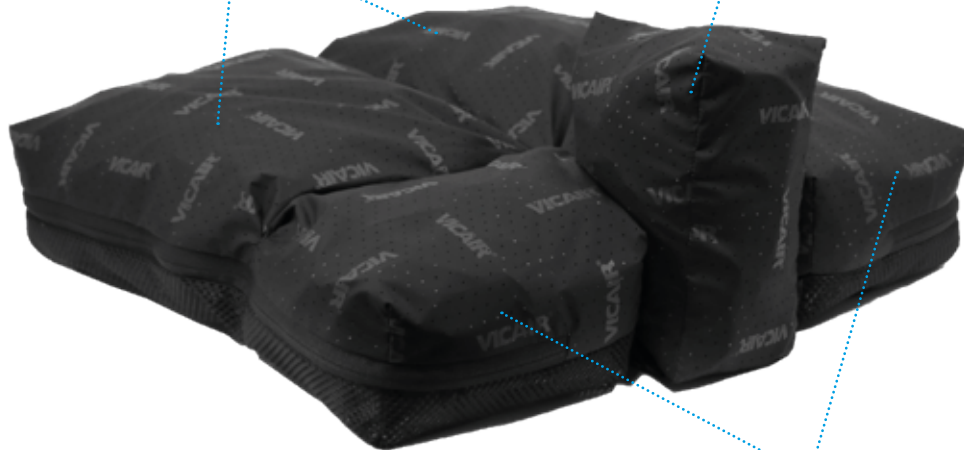

Medial thigh support

Thigh support

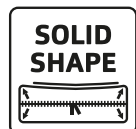
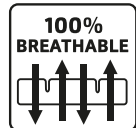

- ▲ Ideal for users with adducted conditions
- ▲ Detachable medial thigh support
- ▲ Cushion and medial thigh support covered separately for ease of use

The Vicair Pommel cushion 02 consists of 5 individual compartments including a detachable medial thigh support. This cushion is ideal for individuals with adducted conditions, where the knees or thighs are pulled together. The detachable medial thigh support gently separates the knees and/or thighs relieving the area of pressure that could normally result in pain. The SmartCell filling ensures a softer padded surface between the knees and/or thighs, redistributing pressure in this area and therefore also reducing the risk for pressure injuries. The detachable medial thigh support can be removed to facilitate forward transfers or catheterisation whilst remaining in the wheelchair.

**PRODUCT PERFORMANCE**

**Skin protection / Anti decubitus**

Pressure redistribution	▲▲▲▲▲
Shear force reduction	▲▲▲▲△
Microclimate control	▲▲▲▲▲
Impact & vibration damping	▲▲▲▲▲

**Positioning**

Lateral stability	▲▲▲▲△
Frontal stability	▲▲▲▲▲
Sliding reduction	▲▲▲▲△
Allows manual adjustments	▲▲▲▲▲
Increasing endurance	▲▲▲▲△

**Maintenance & Safety**

Durability	▲▲▲▲▲
Reliability	▲▲▲▲△
Functionality when misused	▲▲▲△△
Easy to maintain	▲▲▲▲△
Level of hygiene	▲▲▲▲▲

**Functionality & Application**

Comfort	▲▲▲▲▲
Ultra light weight	▲▲▲▲▲
Allows easy transfers	▲▲▲△△
Available standard sizes	▲▲▲▲▲
Maximum user weight	▲▲▲▲△

**TECHNICAL SPECIFICATIONS**

Thickness	10 cm
Average weight	850 grams
Max. user weight	250 kg
Machine washable	60°C max.

**CUSHION SIZES**

- Standard
- On request

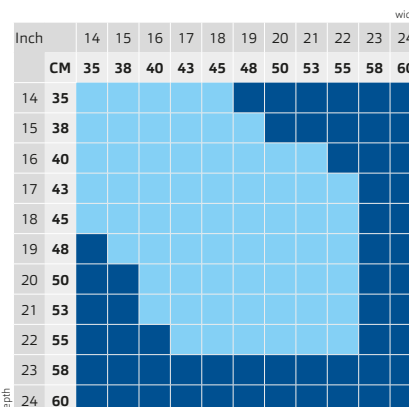

**AVAILABLE COVERS**

Comfair Cover and Incotec Cover.

THE OPTIMAL PEDIATRIC CUSHION

**Trochanter and thigh support**  
firmer density for positioning | provides lateral stability

**Ischial well**  
lower pressure

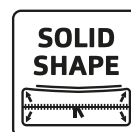
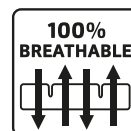

- ▲ Especially designed for children
- ▲ Filled with small-sized SmartCells for optimal pressure redistribution
- ▲ Built to provide carefree mobility

The Vicair Junior Vector 02 is a pre-contoured cushion which consists of 9 individual compartments. This cushion is designed especially for smaller people and pediatric use. Unique are its special, smaller sized SmartCells that safeguard pressure management and positioning properties even in the smallest of cushion sizes. Due to the anthropometrics of the pelvis of the target group, the thickness of only 6 cm is excellent for individual positioning and skin protection. Each compartment is designed to influence a specific area of the pelvis, striking a unique balance between preserving skin at the ischials and coccyx by re-distributing pressures, stabilizing the pelvis and positioning of the femurs. For specific needs the 9 compartments can be easily adjusted.

**PRODUCT PERFORMANCE**

**Skin protection / Anti decubitus**

Pressure redistribution	▲▲▲▲△
Shear force reduction	▲▲▲▲△
Microclimate control	▲▲▲▲▲
Impact & vibration damping	▲▲▲▲▲

**Positioning**

Lateral stability	▲▲▲▲▲
Frontal stability	▲▲▲▲▲
Sliding reduction	▲▲▲▲△
Allows manual adjustments	▲▲▲▲▲
Increasing endurance	▲▲▲▲▲

**Maintenance & Safety**

Durability	▲▲▲▲▲
Reliability	▲▲▲▲▲
Functionality when misused	▲▲▲▲△
Easy to maintain	▲▲▲▲▲
Level of hygiene	▲▲▲▲▲

**Functionality & Application**

Comfort	▲▲▲▲▲
Ultra light weight	▲▲▲▲▲
Allows easy transfers	▲▲▲▲△
Available standard sizes	▲▲△△△
Maximum user weight	▲▲▲△△

**TECHNICAL SPECIFICATIONS**

Thickness	9 cm
Average weight	450 grams
Max. user weight	100 kg
Machine washable	60°C max.

**CUSHION SIZES**

- Standard
- On request

Inch	width					
	10	11	12	13	14	
10	25	28	30	33	35	
11	28	30	33	35		
12	30	33	35			
13	33	35				
14	35					

**AVAILABLE COVERS**

Vicair O2 Top Cover, Comfair Cover and Incotec Cover.





**VICAIR<sup>®</sup>**

**COVERS**

A **cover** to match every  
**situation** and every Vicair  
wheelchair **cushion**

# GENERAL VICAIR COVER INFORMATION

All Vicair covers are made of a multi-way stretchable fabric. This enhances the fantastic immersion and envelopment properties of the Vicair cushions and takes away the negative hammocking effect that is often created when using extra layers of fabric on a cushion.

The backside of all covers has a small loophole, through which you can pull the blue loop attached to back of each cushion. This makes it easy to quickly check if the cushion is placed correctly inside the cover

Hook and loop strips are attached to the bottom of each cover, except for the Vicair O2 Top Cover. The loop strip is sown onto the cover and the hook side has an adhesive strip that you can attach to the seating plane of the wheelchair if there is none yet.

The Vicair O2 Top Cover does not require any extra attachment accessories. Due to the open bottom, the loop strips attached to the bottom of Vicair O2 wheelchair cushions are fully functional. They can easily be attached onto the hook strips of your seating plane, or to the adhesive ones supplied with the cushion.

All Vicair Covers comply with EN1021-1, 1021-2 and CAL117.



**VICAIR®**

**O2 TOP COVER**

## DESIGNED TO ENHANCE THE MICROCLIMATE REGULATION PROPERTIES OF VICAIR O2 WHEELCHAIR CUSHIONS



- ▲ **Enhancing microclimate without compromising envelopment and immersion**
- ▲ **Easily pulled over the top of the cushion**
- ▲ **Shipped in pairs of two - one for use and a spare**

The Vicair O2 Top Cover enhances the microclimate regulation properties of the Vicair O2 wheelchair cushions, without compromising their perfect envelopment and immersion properties. What makes the Vicair O2 Top Cover unique is its closed top and open bottom design. The cover is made out of a 4-way stretch fully permeable fabric with an anti-slip material on its bottom ridge. It only covers the top part, allowing the cushion to breathe to its maximum capacity.

Due to the fully permeable properties and open bottom, the cover can regulate microclimate by managing both heat and moisture.

### TECHNICAL SPECIFICATIONS

Materials	Polyester fabric, polyurethane anti-slip coating, latex free
Machine washable	60°C max.

**DESIGNED TO ENHANCE THE EXCELLENT PRESSURE MANAGEMENT PROPERTIES OF VICAIR CUSHIONS**



- ▲ **Optimal immersion and envelopment**
- ▲ **Designed to prevent hammocking**
- ▲ **3D mesh sides to enhance breathability**

The Comfair Cover enhances the excellent pressure management properties of Vicair cushions, but without compromising microclimate properties of the Vicair O2 wheelchair cushions. The most prominent quality of the Comfair Cover is its ability to optimize the immersion and envelopment properties of Vicair cushions, while preventing the negative effects of hammocking. This is possible due to its unique pleated design. The cover is made out of a 4-way stretch fully permeable fabric at the top, a 3D mesh side and a bottom from anti-slip material. The 3D mesh sides allow extra breathability, to support the microclimate regulation properties of the Vicair O2 cushions.

**TECHNICAL SPECIFICATIONS**

Materials	Polyester fabric, polyester 3D mesh polyurethane anti-slip coating, latex free
Machine washable	60°C max.

**DESIGNED TO PROTECT VICAIR CUSHIONS FROM LIQUIDS**



- ▲ **Liquid resistant fabric**
- ▲ **Easy to wipe clean and disinfect**
- ▲ **Popular choice in care center environments**

The Incotec Cover protects the Vicair wheelchair cushions from liquids, but without compromising their excellent pressure management properties. The Incotec Cover can be considered to be ideal in situations where moisture plays a large and/or very frequent role. Other situations where this cover can come in handy, is when the ability to easily wipe the cover clean is desired. The Incotec Cover is for this very reason often chosen in care center environments. It is made out of a 4-way stretch semi-permeable fabric at the top and a bottom from anti-slip material. The top fabric won't allow moisture to go through the cover, but is still somewhat breathable.

**TECHNICAL SPECIFICATIONS**

Materials	Polyester, fluid resistant polyurethane coating, polyurethane anti-slip coating, latex free
Machine washable	60°C max.



**ONE COVER - TWO USABLE SIDES**



- ▲ Liquid resistant fabric
- ▲ One side: easy to clean and disinfect
- ▲ Other side: softer, comfort feel

The Reversible Cover has two usable sides: the standard liquid resistant side and a softer comfort side that can be taken into use by turning the cover inside out. In order to turn the cover inside out the top and bottom side need to be completely unzipped from each other. The cover is made out of a 4-way stretch semi-permeable fabric at the top and a bottom from anti-slip material. When the liquid resistant side is in use, it won't allow moisture to go through but is still somewhat breathable. In this set up the cover can easily be wiped clean. When the softer side is in use the cover is still liquid resistant but harder to wipe clean. This side feels softer and can be experienced as more comfortable.

**TECHNICAL SPECIFICATIONS**

Materials	Polyester, fluid resistant polyurethane coating, polyurethane anti-slip coating, latex free
-----------	---

Machine washable 60°C max.

**BREATHABLE COVER FOR CUSHIONS THAT DO NOT HAVE MICROCLIMATE PROPERTIES**



- ▲ 3D mesh to enhance breathability
- ▲ Available for a seat and back cushion
- ▲ Anti-slip bottom

The Air Exchange Cover is designed for a select number of Vicair wheelchair cushions that do not have sufficient breathability properties themselves. The cover is designed to enhance breathability, the exchange of air, around those cushions as much as possible.

The cover is made out of stretchable, fully permeable 3D mesh fabric, with a bottom from anti-slip material. The 3D mesh fabric is what supports the exchange of air and enhances breathability.

**TECHNICAL SPECIFICATIONS**

Materials	Polyester 3D mesh polyurethane anti-slip coating, latex free
-----------	--

Machine washable 60°C max.



**VICAIR<sup>®</sup>**

**LIBERTY CUSHIONS**

## ULTRA-LIGHTWEIGHT, EASY TO USE AND COMFORTABLE

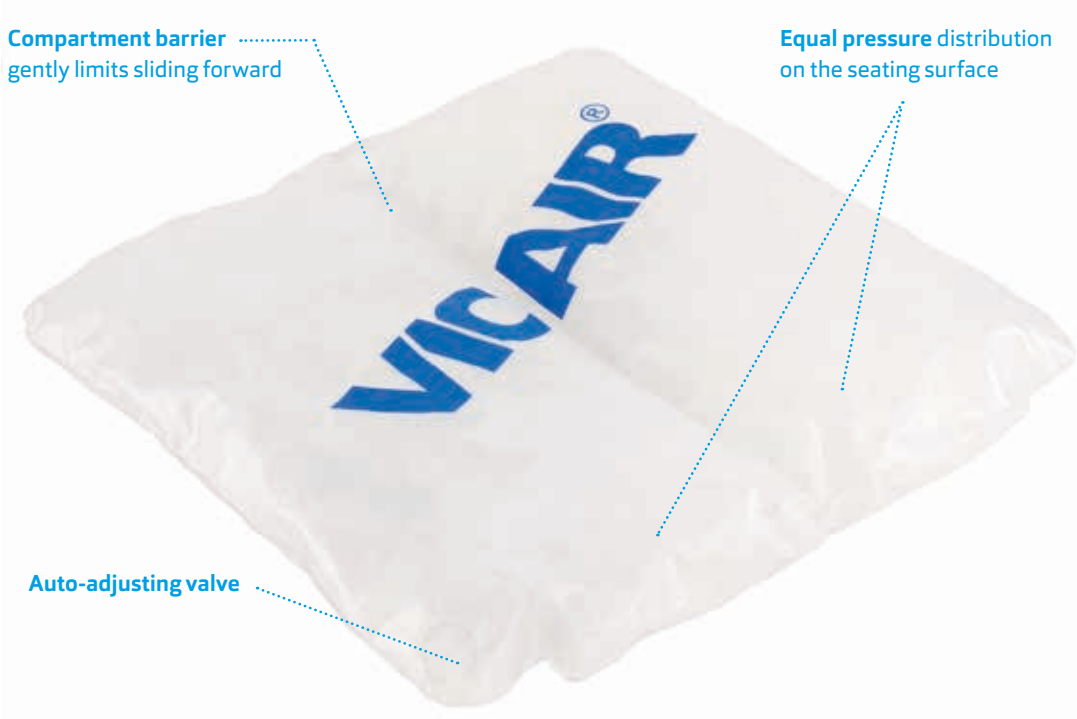

- ▲ Air valve automatically adapts the cushion to your body shape and weight
- ▲ Two compartment layout limits sliding
- ▲ Easy to clean and disinfect

The Vicair Liberty is an easy to use and comfortable wheelchair cushion. It is designed for users who require comfort in combination with a low to medium level of support and pressure injury prevention. The cushion is ready-for-use, rain proof and with two compartments it provides an even pressure distribution. This makes it an ideal cushion in a large variety of situations.

The automatic valve makes sure that the cushion adjust to every seating plane and every body contour.

This Vicair cushion is extremely lightweight.

### PRODUCT PERFORMANCE

#### Skin protection / Anti decubitus

Pressure redistribution	▲▲▲▲△
Shear force reduction	▲▲▲▲△
Microclimate control	▲▲▲▲△
Impact & vibration damping	▲▲▲▲△

#### Positioning

Lateral stability	▲▲▲▲△
Frontal stability	▲▲▲▲△
Sliding reduction	▲▲▲▲△

Allows manual adjustments N/A

Increasing endurance ▲▲▲▲△

#### Maintenance & Safety

Durability	▲▲▲▲△
Reliability	▲▲▲▲△
Functionality when misused	▲▲▲▲△
Easy to maintain	▲▲▲▲▲
Level of hygiene	▲▲▲▲△

#### Functionality & Application

Comfort	▲▲▲▲△
Ultra light weight	▲▲▲▲▲
Allows easy transfers	▲▲▲▲△
Available standard sizes	▲▲▲▲△
Maximum user weight	▲▲▲▲△

### TECHNICAL SPECIFICATIONS

Thickness	5 cm
Average weight	350 grams
Max. user weight	150 kg

### CUSHION SIZES

- Standard
- Not available

Inch	width										
	14	15	16	17	18	19	20	21	22	23	24
CM	35	38	40	43	45	48	50	53	55	58	60
14	35	■	■	■	■	■	■	■	■	■	■
15	38	■	■	■	■	■	■	■	■	■	■
16	40	■	■	■	■	■	■	■	■	■	■
17	43	■	■	■	■	■	■	■	■	■	■
18	45	■	■	■	■	■	■	■	■	■	■
19	48	■	■	■	■	■	■	■	■	■	■
20	50	■	■	■	■	■	■	■	■	■	■
21	53	■	■	■	■	■	■	■	■	■	■
22	55	■	■	■	■	■	■	■	■	■	■
23	58	■	■	■	■	■	■	■	■	■	■
24	60	■	■	■	■	■	■	■	■	■	■

### AVAILABLE COVERS

Comfair Cover and Incotec Cover.

## LIGHTWEIGHT POSITIONING SUPPORT, COMFORTABLE AND EASY TO USE



- ▲ **More stability thanks to the shape of the integrated foam base**
- ▲ **Air valves automatically adapt the cushion to your body shape and weight**
- ▲ **Comfortable and rain proof**

The Vicair Liberty Profile is an easy to use and comfortable wheelchair cushion. Designed for comfort in combination with a low to medium level of support and pressure injury prevention. The Vicair Liberty Profile has an integrated foam base with a semi-circle cut out at the location of the sitting bones. The combination of SmartCells and foam-base supports pelvic stability and offers a high level of comfort in the IT-Coccyx zone. The added second valve allows an even easier automatic adaption to the body shape.

This Vicair cushion is ready-for-use, rain proof and very lightweight.

### AVAILABLE COVERS

Air Exchange Cover and Incotec Cover.

### PRODUCT PERFORMANCE

#### Skin protection / Anti decubitus

Pressure redistribution	▲▲▲△△
Shear force reduction	▲▲△△△
Microclimate control	▲▲△△△
Impact & vibration damping	▲▲▲△△

#### Positioning

Lateral stability	▲▲▲△△
Frontal stability	▲▲▲△△
Sliding reduction	▲▲▲△△
Allows manual adjustments	N/A
Increasing endurance	▲▲▲△△

#### Maintenance & Safety

Durability	▲▲▲△△
Reliability	▲▲▲△△
Functionality when misused	▲▲▲△△
Easy to maintain	▲▲▲△△
Level of hygiene	▲▲▲△△

#### Functionality & Application

Comfort	▲▲▲△△
Ultra light weight	▲▲▲△△
Allows easy transfers	▲▲▲△△
Available standard sizes	▲▲▲△△
Maximum user weight	▲▲▲△△

### TECHNICAL SPECIFICATIONS

Thickness	6 cm
Average weight	600 grams
Max. user weight	150 kg

### CUSHION SIZES

- Standard
- Not available

Inch	width										
	14	15	16	17	18	19	20	21	22	23	24
CM	35	38	40	43	45	48	50	53	55	58	60
14	35										
15	38										
16	40										
17	43										
18	45										
19	48										
20	50										
21	53										
22	55										
23	58										
24	60										



**FOR A COMFORTABLE TOILET VISIT**

Easy clean surface

Easily attached to toilet seat by use of 2 straps

Flat compartment to allow small adjustment to toilet seat shape

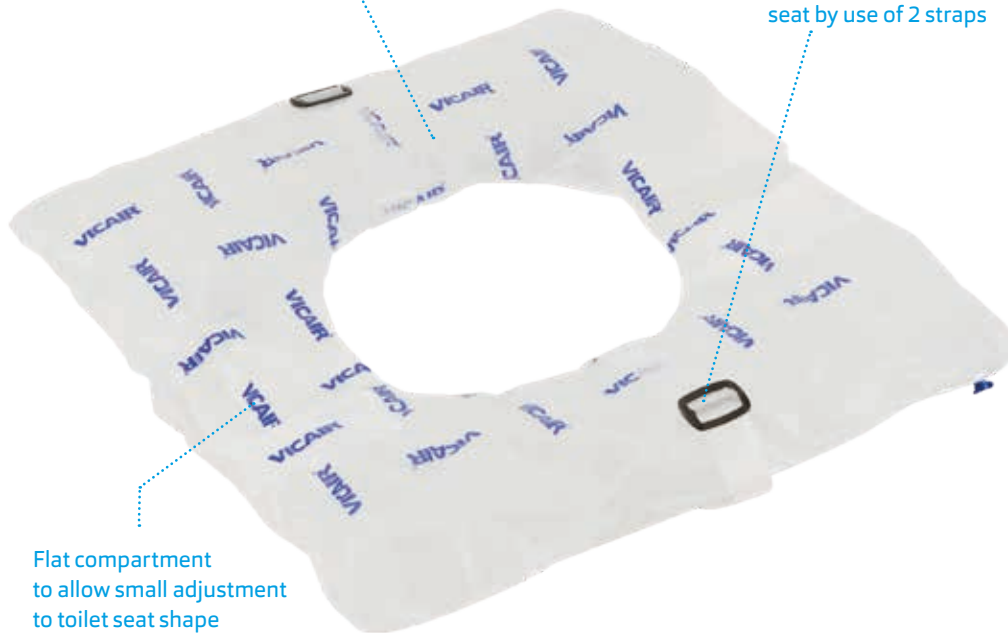

- ▲ Changes the hard toilet seat into a comfortable seating surface
- ▲ Straps for an easy fix onto the toilet seat
- ▲ Watertight which makes it easy to clean and disinfect

The Vicair Liberty TC is a toilet seat cushion that offers comfort and skin protection during toilet visits. It is ideal to use when bowel and bladder management results in a longer toilet routine. The cushion is easy to install: simply strap the lightweight cushion onto the toilet seat. With two available sizes the Liberty TC can be installed on a wide range of toilet seats. The Liberty TC's width is easily adjustable and of course it is easy to clean and disinfect.

**PRODUCT PERFORMANCE**

**Skin protection / Anti decubitus**

Pressure redistribution	▲▲▲▲△
Shear force reduction	▲▲▲▲△
Microclimate control	▲▲▲▲△
Impact & vibration damping	▲▲▲▲△

**Positioning**

Lateral stability	▲▲▲▲△
Frontal stability	N/A
Sliding reduction	N/A
Allows manual adjustments	N/A

Increasing endurance ▲▲▲▲△

**Maintenance & Safety**

Durability	▲▲▲▲△
Reliability	▲▲▲▲△
Functionality when misused	▲▲▲▲△
Easy to maintain	▲▲▲▲△
Level of hygiene	▲▲▲▲△

**Functionality & Application**

Comfort	▲▲▲▲△
Ultra light weight	▲▲▲▲△
Allows easy transfers	▲▲▲▲△
Available standard sizes	▲▲▲▲△
Maximum user weight	▲▲▲▲△

**TECHNICAL SPECIFICATIONS**

Thickness	5 cm
Average weight	350 grams
Max. user weight	150 kg

**CUSHION SIZES**

cm	inches
43x43	17x17
50x45	20x18

Sizes in width x depth



**VICAIR<sup>®</sup>**

**4**

The most **user friendly**  
high performance  
**skin protection**  
wheelchair cushion



## EXTREMELY USER-FRIENDLY AND HIGH PERFORMANCE SKIN PROTECTION

**Colour coded label**  
Easily shows if cushion and cover are the same size

**Safe to use in all directions:**  
top = bottom; left = right;  
front = back.

**4 equal compartments**

- PRESSURE INJURY TREATMENT PLAN**
- 100% BREATHABLE**
- SOLID SHAPE**
- MACHINE WASHABLE**
- READY FOR USE**

- ▲ High performance skin protection by even pressure re-distribution
- ▲ Extreme ease of use
- ▲ Supporting the pelvis and thighs for a stable sitting posture

The Vicair 4 consists of 4 identical individual compartments designed to contour under loading. The cushion is always placed correctly, as all four sides can be either front or back even the top and bottom are identical. The configuration of the four compartments is designed to work together to strike a unique balance between comfort, preserving skin and pelvic support. The four identical individual compartments allow for a foolproof correct positioning on the seating surface. Vicair 4 cushions and covers have the unique feature of colour coded labels, easily showing if the cushion and cover are the same size. This is considered to be beneficial in environments where many wheelchair cushions are in use at once, such as care centres.

### AVAILABLE COVERS

Comfair Cover and Incotec Cover.

### PRODUCT PERFORMANCE

#### Skin protection / Anti decubitus

Pressure redistribution	▲▲▲▲▲
Shear force reduction	▲▲▲△△
Microclimate control	▲▲▲▲▲
Impact & vibration damping	▲▲▲▲▲

#### Positioning

Lateral stability	▲▲▲▲△
Frontal stability	▲▲▲▲▲
Sliding reduction	▲▲▲▲▲
Allows manual adjustments	N/A
Increasing endurance	▲▲▲▲△

#### Maintenance & Safety

Durability	▲▲▲▲▲
Reliability	▲▲▲▲▲
Functionality when misused	▲▲▲▲▲
Easy to maintain	▲▲▲▲▲
Level of hygiene	▲▲▲▲▲

#### Functionality & Application

Comfort	▲▲▲▲▲
Ultra light weight	▲▲▲▲▲
Allows easy transfers	▲▲▲△△
Available standard sizes	▲▲▲△△
Maximum user weight	▲▲▲▲△

### TECHNICAL SPECIFICATIONS

Thickness	8 cm
Average weight	800 grams
Max. user weight	250 kg
Machine washable	60°C max.

### CUSHION SIZES

- Available
- Not available

Inch	width				
	16	17	18	19	20
CM	40	43	45	48	50
16	■				
17		■			
18			■		
19				■	
20					■



**VICAIR<sup>®</sup>**

**SOFT BACK**

**Extremely lightweight**

**Easy to apply**

**Easy to set up**

**Highly adjustable,  
so better positioning  
options and comfort**

**Little to no maintenance**

relief by air



**THE BEST BACK SUPPORT FOR USERS OF MANUAL TILT-IN-SPACE WHEELCHAIRS AND POWERCHAIRS**



- ▲ Supporting different postures
- ▲ Follows the human spine alignment
- ▲ Optimal pressure redistribution

Excellent pressure redistribution, comfort and support make this back support cushion perfect in a large variety of situations. It can be used in several types of back systems and in tilt-in-space chairs with adjustable seat depth. The cushion is easily fixed onto the solid back support by use of hook and loop strips. With the Vicair Back Connector the Multifunctional O2 Back can also be used on tension adjustable backs such as the Vicair Strap Back. The cushion is developed to support an upright position by creating extra support at lumbar thoracic extension of the spine. It also automatically adapts to the body's contours. The cushion can be adjusted to accommodate optimal positioning and/or pressure management, this while the user is still leaning against the cushion.

**AVAILABLE COVERS**  
Comfair Cover.

PRODUCT PERFORMANCE	
<b>Skin protection / Anti decubitus</b>	
Pressure redistribution	▲▲▲▲▲
Shear force reduction	▲▲▲▲△
Microclimate control	▲▲▲▲▲
Impact & vibration damping	▲▲▲▲▲
<b>Positioning</b>	
Lateral stability	▲▲▲▲△
Frontal stability	N/A
Sliding reduction	▲▲▲▲▲
Allows manual adjustments	▲▲▲▲▲
Increasing endurance	▲▲▲▲▲
<b>Maintenance &amp; Safety</b>	
Durability	▲▲▲▲▲
Reliability	▲▲▲▲▲
Functionality when misused	▲▲▲▲△
Easy to maintain	▲▲▲▲△
Level of hygiene	▲▲▲▲▲
<b>Functionality &amp; Application</b>	
Comfort	▲▲▲▲▲
Ultra light weight	▲▲▲▲△
Allows easy transfers	▲▲▲▲△
Available standard sizes	▲▲▲▲△
Maximum user weight	▲▲▲▲△

TECHNICAL SPECIFICATIONS	
Length	36-60 cm
Average weight	975 grams
Max. user weight	150 kg
Machine washable	60°C max.
Loss of seat depth	3 cm

**CUSHION SIZES**  
■ Standard  
■ On request

length	width												
	Inch	14½	14¾	16	16½	17	18	18½	19	20	21½	23	24
CM	36	37	40	41	43	45	46	48	50	54	58	60	
14½	36												
15	38												
16	40												
17	43												
18	45												
19	48												
20	50												
20¾	52												
21½	54												
23	58												
24	60												

**OPTIMAL POSITIONING AND SUPPORT FOR EVERY INDIVIDUAL MANUAL WHEELCHAIR USER**



**PRESSURE INJURY TREATMENT PLAN**

- ▲ **Optimal positioning through a combination of SmartCells and Strap back**
- ▲ **Offloading the spinal column**
- ▲ **Dynamically moulds to the individual's back contours**

The Vicair Anatomic back is a highly comfortable universal back support, that enables optimal positioning and high quality pressure redistribution. Ready for use, as it dynamically adjusts to the contours of the user's back, but also allowing a large variety of individual adjustments. Adjustments can be made with the client still leaning against the cushion. The lightweight cushion is used in combination with the easy-install Vicair Strap back and can be used in wheelchairs without a back support plate. It is extremely suitable to use with (extreme) spine deformities. The Anatomic back follows asymmetric body contours and keeps you safe and stable.

**PRODUCT PERFORMANCE**

**Skin protection / Anti decubitus**

Pressure redistribution	▲▲▲▲▲
Shear force reduction	▲▲▲▲△
Microclimate control	▲▲▲△△
Impact & vibration damping	▲▲▲▲▲

**Positioning**

Lateral stability	▲▲▲▲△
Frontal stability	N/A
Sliding reduction	▲▲▲▲△
Allows manual adjustments	▲▲▲▲▲
Increasing endurance	▲▲▲▲▲

**Maintenance & Safety**

Durability	▲▲▲▲▲
Reliability	▲▲▲▲▲
Functionality when misused	▲▲▲▲△
Easy to maintain	▲▲▲▲▲
Level of hygiene	▲▲▲△△

**Functionality & Application**

Comfort	▲▲▲▲▲
Ultra light weight	▲▲▲▲△
Allows easy transfers	▲▲▲▲△
Available standard sizes	▲▲▲▲▲
Maximum user weight	▲▲▲▲△

**TECHNICAL SPECIFICATIONS**

Length	32-56 cm
Average weight	900 grams
Max. user weight	150 kg
Loss of seat depth	3 cm

**CUSHION SIZES**

- Standard
- On request

		width					
		Inch	12	14	16	18	20
		CM	30	35	40	45	50
length	12¾	32	■	■	■	■	■
	16	40	■	■	■	■	■
	19	48	■	■	■	■	■
	22½	56	■	■	■	■	■

**AVAILABLE COVERS**

Air Exchange Cover.

**EXCELLENT FOR MANUAL WHEELCHAIR USERS WITH BACK PAIN**



Air technology inside for comfort, support and pressure redistribution



Combine with easy-install adjustable Vicair Strap back for positioning and balance



- ▲ Easy to apply on a standard (folding) wheelchair
- ▲ Automatically adapts to change, including reclining back support
- ▲ Excellent for users with back pain

The Vicair Liberty back cushion changes your wheelchair back from standard into extremely comfortable. Combined with the easy-install Vicair Strap back, the cushion offers perfect pain relief, and follows and gently supports postural and/or anatomical anomalies. This extremely lightweight back cushion is easy in transport, as the wheelchair can still be folded when the cushion is attached to it. An easy solution to create comfort and support.

**PRODUCT PERFORMANCE**

**Skin protection / Anti decubitus**

Pressure redistribution	▲▲▲△△
Shear force reduction	▲▲▲△△
Microclimate control	▲▲△△△
Impact & vibration damping	▲▲▲△△

**Positioning**

Lateral stability	▲▲▲△△
Frontal stability	N/A
Sliding reduction	▲▲▲△△
Allows manual adjustments	N/A
Increasing endurance	▲▲▲△△

**Maintenance & Safety**

Durability	▲▲▲△△
Reliability	▲▲▲△△
Functionality when misused	▲▲▲△△
Easy to maintain	▲▲▲△△
Level of hygiene	▲▲▲△△

**Functionality & Application**

Comfort	▲▲▲△△
Ultra light weight	▲▲▲△△
Allows easy transfers	▲▲▲△△
Available standard sizes	▲▲△△△
Maximum user weight	▲▲▲△△

**TECHNICAL SPECIFICATIONS**

Length	45 cm
Average weight	350 grams
Max. user weight	150 kg
Loss of seath depth	3 cm

**CUSHION SIZES**

Available in 3 sizes. Mentioned cm/inches are the min-max distance between the back canes of the wheelchair.

	cm	inches
LBS/1	36-40	14¼ - 16
LBS/2	40-44	16 - 17½
LBS/3	44-48	17½ - 19

**AVAILABLE COVERS**

Comfair Cover.

**PERFECT TO USE IN COMBINATION WITH LIBERTY BACK AND ANATOMIC BACK**

Hook and look strips to attach cushion

Adjustable straps to adjust to back contours. Number of straps depends on Strap back length



Easy and secure full length hook and loop attachment to wheelchair canes, with screw fixation for additional security



Double zip at the front for addition of lateral support

Double zip at the back to allow fixation of stabilisation bar

- ▲ Easy to apply on manual wheelchairs
- ▲ Perfect positioning and comfort qualities
- ▲ Very lightweight

The Vicair Strap back is a perfect base for Vicair wheelchair back cushions. Quickly installed and combined with your choice of Vicair back cushion it is a high quality alternative to your standard wheelchair back system. The adjustable straps enhance the function of the Vicair back cushions, by offering thoracic stability and backrest positioning.

**USED WITH**

Vicair Liberty back, Vicair Anatomic back, Vicair Multifunctional O2 back (in combination with the Vicair Back Connector)

**TECHNICAL SPECIFICATIONS**

Max. user weight 150 kg

**USE YOUR MULTIFUNCTIONAL O2 BACK CUSHION ON A TENSION ADJUSTABLE STRAP BACK**

Loop fabric to easily install back cushion

Back side made of loop fabric and 3 hook strips



Vanity flap including storage pouch, attachable to the wheelchair seat plane



- ▲ Follows every curve
- ▲ Perforated foam for microclimate properties
- ▲ Easy to apply

The Vicair Back Connector is designed to attach the Vicair Multifunctional O2 back cushion to a tension adjustable strap back, like the Vicair Strap back. The Back Connector is placed against the front side of the straps. It closes the gaps between the straps, while still smoothly following the contours created by the adjusted straps. This then forms a solid base for the Multifunctional O2 back cushion.

**USED WITH**

Vicair Multifunctional O2 back (in combination with the Vicair Strap Back)

**TECHNICAL SPECIFICATIONS**

Max. user weight 150 kg



## FOR OPTIMAL LYING COMFORT



- ▲ Optimal pressure redistribution
- ▲ Pain relief
- ▲ Extremely suitable for immobile users

Pain relief, unrest reduction, reduce the risk of paratonia and excellent in a pressure injury treatment plan up to category IV (clinically proven). These are just some examples of the immediate relief provided by the Vicair Mattress 415. The design offers optimal pressure redistribution, reduction of shear forces, optimal immersion and envelopment, stable – yet comfortable – positioning. It's ideal in situations where alternating pressure is a contra-indication (e.g. Osteoporosis, Bone Tumors).

The Vicair SmartCell air-filling makes the Vicair Mattress 415 an extremely lightweight and non-powered alternative to other air-technique replacement mattresses. The Vicair Mattress 415 is low maintenance and comes with a semi permeable, fluid proof and breathable cover. It can be used on any type of bedframe and bedframe position (e.g. semi fowler's position).

CPR can be performed on a patient without the use of a board. Our standard available mattresses are easy to adjust to specific needs of the client. Custom shapes and sizes on request.

### PRODUCT PERFORMANCE

#### Skin protection / Anti decubitus

Pressure redistribution	▲▲▲▲▲
Shear force reduction	▲▲▲▲▲
Microclimate control	▲▲▲▲△
Impact & vibration damping	▲▲▲▲▲

#### Maintenance & Safety

Durability	▲▲▲▲▲
Reliability	▲▲▲▲▲
Functionality when misused	▲▲▲▲△
Easy to maintain	▲▲▲▲△
Level of hygiene	▲▲▲▲△

#### Functionality & Application

Comfort	▲▲▲▲▲
Ultra light weight	▲▲▲▲▲
Allows easy transfers	▲▲▲▲△
Available standard sizes	▲▲▲▲△
Maximum user weight	▲▲▲▲△

### TECHNICAL SPECIFICATIONS

Thickness	15 cm
Average weight	10 kg
Max. user weight	250 kg

### MATTRESS SIZES

Standard	On request	Not available
----------	------------	---------------

Inch	width											
	27	28	30	32	34	36	38	40	42	44	46	48
CM	68	70	75	80	85	90	95	100	105	110	115	120
56	Standard	Not available	Not available	Not available	Not available	Not available	Not available	Not available	Not available	Not available	Not available	Not available
72	Standard	Standard	Standard	Standard	Standard	Standard	Standard	Standard	Standard	Standard	Standard	Standard
74	Standard	Standard	Standard	Standard	Standard	Standard	Standard	Standard	Standard	Standard	Standard	Standard
76	Standard	Standard	Standard	Standard	Standard	Standard	Standard	Standard	Standard	Standard	Standard	Standard
78	Standard	Standard	Standard	Standard	Standard	Standard	Standard	Standard	Standard	Standard	Standard	Standard
80	Standard	Standard	Standard	Standard	Standard	Standard	Standard	Standard	Standard	Standard	Standard	Standard
82	Standard	Standard	Standard	Standard	Standard	Standard	Standard	Standard	Standard	Standard	Standard	Standard
84	Standard	Standard	Standard	Standard	Standard	Standard	Standard	Standard	Standard	Standard	Standard	Standard
86	Standard	Standard	Standard	Standard	Standard	Standard	Standard	Standard	Standard	Standard	Standard	Standard
88	Standard	Standard	Standard	Standard	Standard	Standard	Standard	Standard	Standard	Standard	Standard	Standard



# CUSTOM MADE ENDLESS POSSIBILITIES

Medical practitioners often work with complex cases in the field of seating and positioning. Generally our Vicair Adjuster O2 and Vector O2 cushions are able to offer a solution, but sometimes it is necessary to provide a solution that is custom made for the client. For those situations it is possible to create a Vicair Custom Made seat- or back cushion.

Since 1993 Vicair has been creating products specifically designed for clients with complex disabilities or with specific body contours. The flexibility of the Vicair technique, based on SmartCells, makes this relatively easy to do. Our R&D team department consists of a medical doctor, a physiotherapist and a product designer.

The request for a Vicair Custom Made product is usually made by one of the product specialists of our distributors. They work closely together with the medical practitioner in the process of ordering the Vicair Custom Made product.

First the specific case is discussed in a Vicair R&D team meeting. Based on the description of the client's medical background and needs, the R&D department is able to start designing the product and creates a 3D drawing. The drawing will be discussed with the product specialist and the medical practitioner. After the design has been approved, the production of the cushion commences. Vicair has its own Product Design Studio, so within a few weeks the Vicair Custom Made product is ready to be shipped. The medical practitioner further guides the installation of the product.

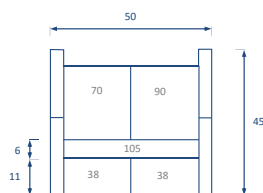
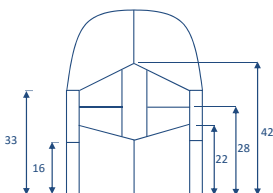
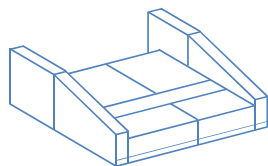
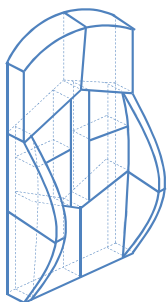

# QUALITY WARRANTY ISO



## Quality

Vicair is devoted to the development and production of products that will positively influence the daily comfort of the wheelchair user, to offer him or her as much freedom as possible.

We expect our products to be of very high quality, to ensure a reliable and safe result. During production all procedures and processes are performed as documented in our quality management system, in which we have implemented the applicable ISO standards and CE regulations.

## Warranty

Vicair offers a limited warranty against defects in workmanship and materials for a period of 24 months (for mattresses this is 5 years) after the original date of purchase, provided the product has been used normally. Any damage arising from abnormal use, or caused by improper handling, cleaning, or negligence, is excluded from this warranty. Should a defect in materials or workmanship occur within 24 months (for mattresses this is within 5 years) from the original date of purchase, Vicair will, at its own choice, repair or replace the product free of charge. The cushion cover is excluded from this warranty. The latest generation Vicair SmartCells (grey with black logo print) have a lifelong warranty period.

Remedies for breach of express warranties herein are limited to repair or replacement of the product. In no event shall damages for breach of any warranty include any consequential damages or exceed the cost of non-conforming goods sold.

## ISO certified

Vicair is ISO 13485 certified. This means it has a comprehensive quality management system for the design and manufacture of medical devices.

## MDR compliant

On the 26th of May 2021 the new Medical Device Regulation (MDR), a set of regulations that governs the production and distribution of medical devices in Europe, came into force. The MDR is mandatory for medical device companies that want to sell their products in the European marketplace.

At Vicair we work with MDR-compliant regulatory systems, processes, and documents to continually monitor the safety and performance of our products.

relief by air

**VICAIR<sup>®</sup>**

Bruynvisweg 5  
1531 AX Wormer  
The Netherlands  
T + 31 (0)75 642 99 99  
info@vicair.com  
vicair.com

Follow us on

