

Tel: 01 810 7084 Fax: 01 810 7085  
Email: ordersireland@invacare.com  
Online spares available at www.invacare.ie

January 2020

Customer Ref:	Account No :
Contact No:	Order No :
Delivery address :	Order Qty :
	Order Date :

## Küschall® Ultra Light IRELAND

### Standard Features:



- Active, Lightweight, Folding Aluminium Frame
- Multiple Adjustments including Front and Rear Seat Heights and Centre of Gravity
- Fixed Front Frame choice of 70° or 80° Angles with Flip up Plastic Footrests
- Choice of 12 Seat Widths 280mm - 500mm (11" - 20")
- Choice of 10 Seat Depths 320mm - 500mm (12" - 20")
- Fixed Backrest Tubes set at 90° with Standard Light Nylon Upholstery
- Standard Push Handles
- Fixed Carbon Clothesguards
- 5" Comfort Front Castors with Black Tyres
- 24" Self Propel Q/R Wheels with Grey Aluminium Handrims & Schwalbe Black & Grey Pneumatic Tyres
- Pull to Lock Brake
- Choice of 13 Frame Colours

**Standard Base Price: €2,203**



\* Configurations may vary from the image shown

	<input checked="" type="checkbox"/>	Please make your selection with a cross in the box	◆ Standard feature	○ Free of Charge
		Customer weight =	Kg	
Code	<input checked="" type="checkbox"/>	Description		Ireland
DDU0010		Küschall® Ultra-Light		€2,203
DDZ0000		MYKüschall® Ultra-Light Special Basic Model - PLEASE COMPLETE DETAILS AT THE END OF THE FORM		P.O.A.

### SEATING CHOICE

#### FRONT FRAME

DDU0203	70° Front frame angle		◆
DDU0212	80° Front frame angle	(NC: 0820,0821,0822,0855)	○

#### Folding back function is limited when selected with Tapered frames

DDU0201	70° Tapered frame angle	(NC: 0118,0120)	○
DDU0243	80° Tapered frame angle	(NC: 0118,0120,0820,0821,0822,0855)	○

#### SEAT WIDTH (SW) & SEAT DEPTH (SD)

	Seat Width in mm											
	280mm DDU0118	300mm DDU0120	320mm DDU0122	340mm DDU0124	360mm DDU0126	380mm DDU0128	400mm DDU0130	420mm DDU0132	440mm DDU0134	460mm DDU0136	480mm DDU0138	500mm DDU0140
Seat Depth in mm	320mm DDU0408	o	o	o	o	o	o	o	o	o	o	o
	340mm DDU0410	o	o	o	o	o	o	o	o	o	o	o
	360mm DDU0412	o	o	o	o	o	o	o	o	o	o	o
	380mm DDU0415	o	o	o	o	o	o	o	o	o	o	o
	400mm DDU0417	o	o	o	o	o	o	o	o	o	o	o
	420mm DDU0420	o	o	o	o	o	o	o	o	o	o	o
	440mm DDU0422	o	o	o	o	o	o	o	o	o	o	o
	460mm DDU0424	o	o	o	o	o	o	o	o	o	o	o
	480mm DDU0427	o	o	o	o	o	o	o	o	o	o	o
	500mm DDU0429	o	o	o	o	o	o	o	o	o	o	o

Seat widths 280mm - 420mm are fitted with a single crossbar. Max user weight 100kg/16 Stone

Seat widths 440mm - 500mm are fitted with a double crossbar. Max user weight 130kg/20.5 Stone

Light back upholstery, option 0721 is not available on seat widths 280mm - 320mm or 500mm or on backrest heights less than 360mm

Seat widths 280mm & 300mm not available with tapered frames

Matrix backrests are not compatible with seat widths 280mm - 340mm

Matrix MX1 backrest is not compatible with seat widths 480mm & 500mm

Seat width 360mm on Matrix Libra & Vi cushions is only available with 400mm & 420mm seat depths

Matrix Libra cushion is compatible with seat sizes 360-500mm wide and 400-500mm deep

Matrix Vi cushion is compatible with seat sizes 360-500mm wide and 400-500mm deep

Seat depths 320mm - 380mm not available with 7" castors

Matrix Elite standard backrest, height 360mm, option DDU0760 is not available with seat widths 480mm & 500mm

Seat widths 280mm - 320mm are only compatible with 1 or 2 piece carbon footplates. Options DDU1578,1579,1566 & 1567

On tapered frames, seat widths 320mm - 360mm are only compatible with 1 or 2 piece carbon footplates. Options DDU1578,1579,1566 & 1567

Seat depth 320mm is not possible with backrest angles 82° and 86° options DDU0707 & 0718

**BACK HEIGHT (BH)**

Back Height in mm							
300mm DDU0550	o	315mm DDU0503	o	330mm DDU0506	o	345mm DDU0509	o
360mm DDU0512	o	375mm DDU0514	o	390mm DDU0516	o	405mm DDU0518	o
420mm DDU0520	o	435mm DDU0522	o	450mm DDU0524	o	465mm DDU0526	o
480mm DDU0528	o	495mm DDU0530	o	510mm DDU0532	o		

Back heights 300mm - 330mm are not compatible with folding backrest, option DDU0734

Back heights 300mm - 345mm are not compatible with light back upholstery, option DDU0721

Back height 345mm is not compatible with folding backrest, option DDU0734 in combination with backrest angles 94° & 98°

Matrix backrests are available to order with the Ultra-Light. Specific backposts supplied in aluminium. The chair can be supplied with Matrix fitted or supplied without upholstery for retro fitting a backrest. If either is required, select option 0585. The full height of the backrest will depend on the height of the Matrix back selected. Refer to the Matrix section for further details.

Please note this chair can't be used as a seat in transportation if the back height is lower than 405mm

Back heights 300mm - 390mm are not compatible with backrest stabilization bar, option DDU1491

DDU0585

Backposts to suit Matrix or fixed backrests. Supplied without upholstery, only compatible with fixed backrest DDU0736

o

**FRONT SEAT-TO-FLOOR HEIGHT (FSTF)**

Front Seat to Floor in mm					
430mm DDU0845	440mm DDU0846	450mm DDU0847	460mm DDU0848	470mm DDU0849	480mm DDU0850
o	o	o	o	o	o
490mm DDU0851	500mm DDU0852	510mm DDU0853	520mm DDU0854	530mm DDU0855	
o	o	o	o	o	

Maximum front seat height with 80° front frame is 520mm

**REAR SEAT-TO-FLOOR HEIGHT (RSTF)**

Mudguards in combination with a rear wheel extension are not compatible with rear seat to floor heights of 410mm or lower

Rear Seat to Floor in mm					
390mm DDU0944	400mm DDU0945	410mm DDU0946	420mm DDU0947	430mm DDU0948	440mm DDU0949
o	o	o	o	o	o
450mm DDU0950	460mm DDU0951	470mm DDU0952	480mm DDU0953	490mm DDU0954	500mm DDU0955
o	o	o	o	o	o

On 70° frame rear seat height can be from 0cm upto 10cm lower than front seat height.

On 80° frames rear seat height can be from 3cm upto 10cm lower than front seat height

Mudguards DDU1405 in combination with rear wheel extension DDU0249 are not compatible with rear seat heights of 410mm or lower

**Rear wheel size/Rear seat height**

22" : 390-470 mm

24" : 390-490 mm

26" : 420-500 mm

**LOWER LEG LENGTH (LLL)**

200mm DDU1661	o	210mm DDU1662	o	220mm DDU1663	o	230mm DDU1664	o	240mm DDU1665	o
250mm DDU1666	o	260mm DDU1667	o	270mm DDU1668	o	280mm DDU1669	o	290mm DDU1670	o
300mm DDU1671	o	310mm DDU1672	o	320mm DDU1673	o	330mm DDU1674	o	340mm DDU1675	o
350mm DDU1676	o	360mm DDU1677	o	370mm DDU1678	o	380mm DDU1679	o	390mm DDU1680	o
400mm DDU1681	o	410mm DDU1682	o	420mm DDU1683	o	430mm DDU1684	o	440mm DDU1685	o
450mm DDU1686	o	460mm DDU1687	o	470mm DDU1688	o	480mm DDU1689	o	490mm DDU1690	o
500mm DDU1691	o	510mm DDU1692	o						

On 70° legrests, Maximum lower leg length must be front seat height minus 20mm



On 80° legrests, Maximum lower leg length must be front seat height minus 30mm



Lower leg lengths 200mm - 260mm are available with 1 or 2 piece carbon footplates options DDU1578, DDU1579, DDU1566 & DDU1567

Lower leg length must be measured taking away the cushion thickness

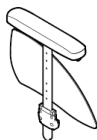
BACKREST CHOICE																								
<b>BACK TUBES</b>																								
DDU0736	Fixed backrest tubes set at 90°		◆																					
DDU0705	Lumbar tubes fixed at 90°	(NC: 0734) Not compatible with Matrix backrests	○																					
DDU0720	Angle adjustable back (Backrest angle must be selected from the 6 options below)	(NC: 0734) Not compatible with Matrix backrests	€207																					
DDU0734	Fold down back (folds forward onto the seat) Select angle choice from list opposite. Angle selected will be factory set but can be adjusted to the corresponding angle adjustment possibilities.  Not compatible with Tubular Armrests, Option DDU1411  <b>Not compatible with Matrix backrests</b>	<table border="1"> <thead> <tr> <th colspan="3">Folding Back Angle Possibilities</th> </tr> <tr> <th>Back Angle Choice</th> <th colspan="2">Adjustment Possibilities</th> </tr> </thead> <tbody> <tr> <td>82°</td> <td>86°</td> <td>90°</td> </tr> <tr> <td>86°</td> <td>82°</td> <td>90°</td> </tr> <tr> <td>90°</td> <td>82°</td> <td>86°</td> </tr> <tr> <td>94°</td> <td>90°</td> <td>98°</td> </tr> <tr> <td>98°</td> <td>90°</td> <td>94°</td> </tr> </tbody> </table>	Folding Back Angle Possibilities			Back Angle Choice	Adjustment Possibilities		82°	86°	90°	86°	82°	90°	90°	82°	86°	94°	90°	98°	98°	90°	94°	€76
Folding Back Angle Possibilities																								
Back Angle Choice	Adjustment Possibilities																							
82°	86°	90°																						
86°	82°	90°																						
90°	82°	86°																						
94°	90°	98°																						
98°	90°	94°																						
<b>BACKREST ANGLE Must be selected with angle adjustable backrest (0720) and fold down backrest (0734)</b>																								
DDU0707	Angle adjustable backrest, adjusted 82°		○																					
DDU0718	Angle adjustable backrest, adjusted 86°		○																					
DDU0709	Angle adjustable backrest, adjusted 90°		◆																					
DDU0719	Angle adjustable backrest, adjusted 94°		○																					
DDU0711	Angle adjustable backrest, adjusted 98°		○																					
DDU0712	Angle adjustable backrest, adjusted 102°		○																					
<b>BACK UPHOLSTERY</b>																								
DDU0700	Standard, black nylon upholstery, no tension adjustment	(NC: 0703,1491)	◆																					
DDU0721	Lightweight mesh back upholstery, no tension adjustment	(NC: 0703,1491)	€72																					
DDU0726	Premium black nylon with reflective trim upholstery cover, tension adjustable back		€146																					
DDU0735	Aero, breathable spacer upholstery with tension adjustable back		€230																					
DDU0769	Without backrest upholstery. Select only when ordering Matrix backrests or retro fitting a backrest		○																					
<b>MATRIX BACKREST (Hardware is supplied mounted to the backposts with the backrest supplied in the box with the wheelchair, extra leadtime applies) When mounting Matrix backrests, please ensure the upper part of the Matrix backrest is positioned no higher 590mm from the seat.</b>																								
DDU0764	Matrix MX2 with Mini-set hardware Height of backrest 150mm	Compatible with seat widths 360mm - 460mm	€1,202																					
DDU0765	Matrix MX2 with Mini-set hardware Height of backrest 230mm		€1,202																					
DDU0766	Matrix MX2 with Mini-set hardware Height of backrest 305mm		€1,202																					
DDU0767	Matrix MX2 with Mini-set hardware Height of backrest 405mm		€1,202																					
 <p><b>MX2 backrest supplied with Mini-set hardware, spacer fabric cover with leatherette side panels.</b></p> <p>Maximum user weight 113kg/17.8 Stone</p> 																								
DDU0756	Matrix Elite Deep with Easy-set mounting hardware. Height of backrest 310mm	Compatible with seat widths 360mm - 500mm	€677																					
DDU0757	Matrix Elite Deep with Easy-set mounting hardware. Height of backrest 410mm	Compatible with seat widths 360mm - 500mm	€677																					
DDU0762	Matrix Elite Deep with Easy-set mounting hardware. Height of backrest 460mm	Compatible with seat widths 360mm - 500mm	€677																					
DDU0758	Matrix Elite Standard with Easy-set mounting hardware. Height of backrest 260mm	Compatible with seat widths 360mm - 500mm	€677																					
DDU0759	Matrix Elite Standard with Easy-set mounting hardware. Height of backrest 310mm	Compatible with seat widths 360mm - 500mm	€677																					
DDU0760	Matrix Elite Standard with Easy-set mounting hardware. Height of backrest 360mm	Compatible with seat widths 360mm - 460mm	€677																					
DDU0761	Matrix Elite Standard with Easy-set mounting hardware. Height of backrest 410mm	Compatible with seat widths 360mm - 500mm	€677																					
DDU0763	Matrix Elite Standard with Easy-set mounting hardware. Height of backrest 460mm	Compatible with seat widths 360mm - 500mm	€677																					
 <p><b>Matrix Elite Deep</b></p>  <p><b>Matrix Elite Standard</b></p>  <p><b>Matrix Elite Deep and Matrix Elite backrests are supplied with Easy-set hardware and spacer fabric cover</b></p> <p>Maximum user weight</p>																								
DDU1111	Without Matrix backrest, select only if retro-fitting a fixed backrest		○																					

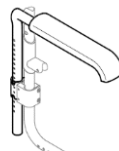
<b>PUSH HANDLES</b>				
DDU0702	Push-handles fixed, long		In combination with Matrix backrests, push handle height will be approximately 475mm from the seat	◆
DDU0751	Push handles fixed, mini	(NC: 1304)	In combination with Matrix backrests, push handle height will be approximately 475mm from the seat	○
DDU0750	Without push handles	(NC: 1304)	In combination with Matrix backrests, the telescopic backpost height will be approx. 350mm from the seat	○
DDU0703	Height adjustable, rear set, maximum height of push handles is rear seat height + 600mm		(NC: 0734,1304,1411)	€261
DDU0733	Height adjustable, integrated		(NC: 1304,1491)	€126
DDU0704	Foldable push handles		(NC: 1304,1491) In combination with Matrix backrests, push handle height will be approx. 450mm from the seat	€203
<b>BACKBRACE</b>				
DDU1491	Backrest stabilization bar, swingaway and removable (Not compatible with Matrix backrests or with backrest heights lower than 405mm)			€127
<b>SEATING</b>				
DDU0611	Standard adjustable seat upholstery with 1 central (loop) band			◆
DDU0614	Seat upholstery with 1 central (loop) and 2 side bands (hook)			€41
<b>SEATING OPTIONS</b>				
DDU0600	Standard seat cushion, 6cm foam with Visco top layer			€65
DDU0662	Matrix Libra with Black Smooth cover Very high risk pressure & positioning cushion		Matrix Libra is compatible with seat sizes 360-500mm wide & 400-500mm deep	€516
DDU0663	Matrix Vi with Black Meshtex cover High risk pressure & positioning cushion		Matrix Vi is compatible with seat sizes 360-500mm wide & 400-500mm deep	€338
DDU0606	Seat Bag (click in and removable)			€77
<b>FOOTREST</b>				
<b>Seat widths 280mm - 320mm with an Aluminium frame and seat widths 320mm - 360mm on a Tapered frame, only with 1piece or 2piece Carbon footplates</b>				
DDU1562	2 pc. plastic, set to front		High mounted for knee to heel less than 370mm	◆
DDU1563	2 pc. plastic, set to back		High mounted for knee to heel less than 370mm	○
DDU1564	2 pc. plastic angle adjustable set to front		High mounted for knee to heel less than 420mm	€133
DDU1565	2 pc. plastic angle adjustable set back		High mounted for knee to heel less than 420mm	€133
DDU1578	2 pc. carbon footplates, angle adjustable set to the front		(NC: 1530) High mounted for less than 320mm	€345
DDU1579	2 pc. carbon footplates, angle adjustable set to the rear		(NC: 1530) High mounted for less than 320mm	€345
DDU1566	1 pc. carbon Flip-up to the left, adjustable, fixed on 1 side when folded, set to front		(NC: 1530) Not possible for knee to heel less than 320mm	€171
DDU1567	1 pc. carbon Flip-up to the left, adjustable, fixed on 1 side when folded, set to back		(NC: 1530) Not possible for knee to heel less than 320mm	€171
<b>FOOT AND LEG SUPPORT</b>				
DDU1533	Calf strap			◆
DDU1530	Heel loops			○
<b>SIDE GUARDS</b>				
<b>CLOTHES &amp; MUD GUARDS</b>				
DDU1400	Clothes guards carbon, fixed		Clothesguards and mudguards are not compatible with armrest options (DDU1416,1421,1445) clothesguards are included on armrests.	◆
DDU1405	Mud guards carbon, fixed			€147
DDU1408	Mudguards carbon, removable (Adds 20mm to the total width of the chair)			€263

ARMRESTS (Includes clothes guards, adds 20mm to total width of the chair)																											
DDU1416		Armrest height adjustable (with tools), removable, short pad, non-locking	○																								
DDU1421		Armrest height adjustable (with tools), removable, long pad, non locking	○																								
DDU1445		Kuschall height adjustable armrest black. Lockable, removable, swingaway and flip back	In combination with performance brakes, this armrest is not available with 4th, 5th & 6th rear wheel positions. €333																								
DDU1411		Tubular Armrest with comfort padded arms. Non locking, height adjustable, removable and swingaway. Does not include clothesguards	€247																								
<div style="display: flex; justify-content: space-around; align-items: center;"> <div style="text-align: center;">  <p><b>DDU1416 DDU1421</b> Height adjustable armrest</p> </div> <div style="text-align: center;">  <p><b>DDU1445</b> Kuschall height adjustable armrest with black cover</p> </div> <div style="text-align: center;">  <p><b>DDU1411</b> Tubular armrest</p> </div> </div>																											
FRAME COLOUR																											
DDU0300		Glossy-Black	Select either full frame colour, option DDU0398 or rear frame and crossbar matt black option DDU0399																								
DDU0314		Black Matt																									
DDU0356		Ivory White																									
DDU0302		Royal Blue																									
DDU0303		Royal Red																									
DDU0350		Purple Fire																									
DDU0354		Night Shimmer																									
DDU0315		Silver Grey																									
DDU0358		Smokey Grey																									
DDU0365		Mercury Blue (Available with option DDU0399 only)		These 4 colours are only available with rear frame and crossbar in matt black with front frames in selected colour Select option DDU0399																							
DDU0366		Dynamite Orange (Available with option DDU0399 only)																									
DDU0367		Atomic Violet (Available with option DDU0399 only)																									
DDU0368		Nitro Pink (Available with option DDU0399 only)																									
FRAME COLOUR TYPE																											
DDU0398		Full frame colour, front, rear frame and crossbar painted in selected colour	○																								
DDU0399		Rear frame and crossbar matt black, front frame in selected colour	○																								
COLOUR-POWER-SET																											
Consists of selected colour on castor forks, rear wheel hub, Starec wheel rim & Q/R button, seat rail caps, standard rear wheel fixation, standard castor housing block																											
DDU0330		Colour-Power-Set techno-anthracite	€229																								
DDU0334		Colour-Power-Set b-blue	€229																								
DDU0329		Colour-Power-Set comet red	€229																								
DDU0337		Colour-Power-Set copper glaze	€229																								
DDU0336		Colour-Power-Set arctic blue	€229																								
DDU0338		Colour-Power-Set chrome	Starec wheel rim supplied in black when Chrome CPS is selected €229																								
DDU0339		Colour-Power-Set champagne	€229																								
DDU0340		Colour-Power-Set olive	€229																								
FRONT WHEEL ATTACHMENT																											
DDU0864		High mounted (Frame will be 30mm lower)	<table border="1" style="width: 100%; text-align: center;"> <thead> <tr> <th colspan="4">Front Castor/Front Seat Height Matrix</th> </tr> <tr> <th>Front castor size</th> <th>Castor attachment High mounted</th> <th>Castor attachment Standard mounted</th> <th>Castor attachment Low mounted</th> </tr> </thead> <tbody> <tr> <td>4"</td> <td>410 - 480mm</td> <td>440 - 510mm</td> <td>470 - 530mm</td> </tr> <tr> <td>5"</td> <td>440 - 490mm</td> <td>470 - 520mm</td> <td>500 - 530mm</td> </tr> <tr> <td>6"</td> <td>460 - 510mm</td> <td>490 - 530mm</td> <td>520 - 530mm</td> </tr> <tr> <td>7"</td> <td>480 - 520mm</td> <td>510 - 530mm</td> <td>540 - 550mm*</td> </tr> </tbody> </table>	Front Castor/Front Seat Height Matrix				Front castor size	Castor attachment High mounted	Castor attachment Standard mounted	Castor attachment Low mounted	4"	410 - 480mm	440 - 510mm	470 - 530mm	5"	440 - 490mm	470 - 520mm	500 - 530mm	6"	460 - 510mm	490 - 530mm	520 - 530mm	7"	480 - 520mm	510 - 530mm	540 - 550mm*
Front Castor/Front Seat Height Matrix																											
Front castor size	Castor attachment High mounted	Castor attachment Standard mounted		Castor attachment Low mounted																							
4"	410 - 480mm	440 - 510mm		470 - 530mm																							
5"	440 - 490mm	470 - 520mm	500 - 530mm																								
6"	460 - 510mm	490 - 530mm	520 - 530mm																								
7"	480 - 520mm	510 - 530mm	540 - 550mm*																								
DDU0865		Standard mounted	◆																								
DDU0866		Low mounted (Frame will be 30mm higher)	○																								
			* These measurements can be achieved as a special build, contact our specials department for further details																								

FRONT WHEEL, 6" & 7" not possible with Dynamic 80° frame			
DDU0801	100mm x 30mm (4" x 1.2") Everyday wheel with black tyre		○
DDU0860	100mm x 30mm (4" x 1.2") Comfort wheel with black tyre		○
DDU0809	100mm x 25mm (4" x 1") Starec black hub, black tyre		€69
DDU0861	100mm x 25mm (4" x 1") Starec chrome hub, black tyre		€69
DDU0803	100mm x 25mm (4" x 1") Starec techno-anthracite hub, black tyre		€69
DDU0808	100mm x 25mm (4" x 1") Starec comet red hub, black tyre		€69
DDU0830	100mm x 25mm (4" x 1") Starec copper glaze hub, black tyre		€69
DDU0825	100mm x 25mm (4" x 1") Starec champagne hub, black tyre		€69
DDU0807	100mm x 25mm (4" x 1") Starec b-blue hub, black tyre		€69
DDU0831	100mm x 25mm (4" x 1") Starec arctic blue hub, black tyre		€69
DDU0826	100mm x 25mm (4" x 1") Starec olive hub, black tyre		€69
DDU0796	100mm x 36mm (4" x 1.4") Softroll aluminium, black hub, black tyre		€103
DDU0797	100mm x 36mm (4" x 1.4") Softroll aluminium, silver hub, black tyre		€103
DDU0810	125mm x 30mm (5" x 1.2") Everyday wheel with black tyre		○
DDU0863	125mm x 30mm (5" x 1.2") Comfort wheel with black tyre		◆
DDU0819	125mm x 25mm (5" x 1") Starec black hub, black tyre		€69
DDU0862	125mm x 25mm (5" x 1") Starec chrome hub, black tyre		€69
DDU0813	125mm x 25mm (5" x 1") Starec techno-anthracite hub, black tyre		€69
DDU0818	125mm x 25mm (5" x 1") Starec comet red hub, black tyre		€69
DDU0833	125mm x 25mm (5" x 1") Starec copper glaze hub, black tyre		€69
DDU0827	125mm x 25mm (5" x 1") Starec champagne hub, black tyre		€69
DDU0817	125mm x 25mm (5" x 1") Starec b-blue hub, black tyre		€69
DDU0832	125mm x 25mm (5" x 1") Starec arctic blue hub, black tyre		€69
DDU0828	125mm x 25mm (5" x 1") Starec olive hub, black tyre		€69
DDU0798	125mm x 36mm (5" x 1.4") Softroll aluminium, black hub, black tyre		€103
DDU0799	125mm x 36mm (5" x 1.4") Softroll aluminium, silver hub, black tyre		€103
DDU0820	150mm x 30mm (6" x 1.2") Comfort wheel with black tyre	Not possible with 80° front frame	○
DDU0821	150mm x 30mm (6" x 1.2") Pneumatic Wheel	Not possible with 80° front frame	€32
DDU0822	175mm x 30mm (7" x 1.2") Comfort wheel with black tyre	Not possible with 80° front frame	○
REAR WHEEL ADAPTION PLATE			
DDU0250	Standard fixation, 4 rear wheel positions		Please note, if armrests and 3 degrees of camber are selected in combination with CPS, the standard fixation bracket will be supplied in black ◆
DDU0249	Rear wheel extension, 6 rear wheel positions (Always supplied black in colour)		€67
REAR WHEEL POSITION			
DDU0263	1st position	(NC: 0249,0283,1304)	○
DDU0264	2nd position		○
DDU0265	3rd position		◆
DDU0266	4th position	(NC: 0927)	○
DDU0267	5th position	5th & 6th position not for standard fixation DDU0250	○
DDU0268	6th position	Not compatible with DDU0927 Wheels with hub brakes	○
QUAD QUICK RELEASE AXLE			
DDU0909	Quad quick release axle	(NC: 0906,0927,1304)	€87
REAR WHEEL SIZE			
DDU0901	22"	(NC: 0906,0908,0927)	○
DDU0902	24"		◆
DDU0903	26"	(NC: 0283,0906,0908,0927)	○
REAR WHEEL CAMBER (3° Not available with drum brakes and performance brakes combined)			
DDU0282	Camber 0°		◆
DDU0283	Camber 3°	(NC: 1302,1304)	○
REAR WHEEL TYPE			
DDU0915	22", 24", 26" Kuschall Starec (Silver crossed spokes, hub colourless, rim black. Hub & rim in CPS if selected)		◆
DDU0908	24" High Performance (Starec hub, spokes & rim black, hub in CPS if selected)	(NC: 1004,1006,1007,1304)	€281
DDP0906	24" Spinergy LXK wheel (Black lightweight hub, 18 spokes black, No CPS) Coloured spokes are available via MyKuschall, please indicate requirements in the space provided at the end of the form.	(NC: 1004,1006,1007,1200,1202,1208,1399)	€675
SWO0907	24" Spinergy SPOX wheel (Chrome hub, 18 spokes in black, no CPS) Coloured spokes are available via MyKuschall, please indicate requirements in the space provided at the end of the form.	(NC: 1004,1006,1007,1200,1202,1208,1399)	€491
SWO0909	24" Spinergy LX wheel (Chrome hub, 12 spokes in black no CPS). Coloured spokes are available via MyKuschall, please indicate requirements in the space provided at the end of the form.	(NC: 1004,1006,1007,1200,1202,1208,1399)	€762
DDU0927	24" Wheel with integrated brakes (Silver spokes with black hub and rim) CPS not offered on this option	(NC 1004,1006,1007)	€722

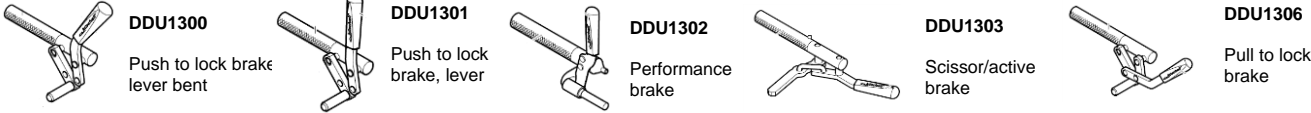
REAR WHEEL TYRE																																																																														
DDU1014	22", 24", 26" Schwalbe Righrun black & grey pneumatic tyre		◆																																																																											
DDU1002	22", 24" Profile 7 bar grey pneumatic tyre		○																																																																											
DDU1004	24" Solid tyre, profile grey		€74																																																																											
DDU1006	24" Solid tyre (KIK type), black		€97																																																																											
DDU1007	22", 24" Solid tyre, light grey		€74																																																																											
DDU1010	24", 26" Marathon Plus, black pneumatic tyre with Smartguard. 5mm layer of protective rubber infill (NC: 1020)		€110																																																																											
DDU1011	24" Schwalbe One V guard, puncture resistant black pneumatic tyre		€97																																																																											
ANTI-FLAT																																																																														
DDU1020	Anti Flat tyre tube protection		€23																																																																											
HANDRIM																																																																														
DDU1113	22", 24", 26" Light Alu grey, short tab, 1 hole set at 3 cm distance		◆																																																																											
DDU1114	22", 24", 26" Light Alu grey, long tab, 2 hole set at 4 cm distance		○																																																																											
DDU1117	22", 24", 26" Light Alu black, short tab, 1 hole set at 3 cm distance		€46																																																																											
DDU1102	22", 24", 26" Supergrripp, long tab, 2 hole set at 3 cm distance		€228																																																																											
DDU1104	24", 26" Steel polished, short tab, 1 hole set at 3 cm distance		€69																																																																											
DDU1106	24" Titanium, short tab, 1 hole set at 3 cm distance		€181																																																																											
DDU1121	24" Carbolife Gekko black coated (fully integrated rubber strip, extra grip) mounted at 3cm distance. 25" & 26" Gekko are available via Myküschall		€391																																																																											
DDU1122	24" Carbolife Curve L black coated (unique shaped profile for low-effort grip) mounted at 3cm dist 25" & 26" Curve L are available via Myküschall		€349																																																																											
SPOKE GUARDS																																																																														
DDU1200	22", 24", 26" Transparent (NC: 1304)		€140																																																																											
DDU1202	24" Küschall Black with white logo (NC: 1304)		€140																																																																											
DDU1208	24" Transparent and white with Küschall logo in black		€140																																																																											
SAFETY																																																																														
DDU1300	Push brake, bent (NC: 1310)	<table border="1"> <thead> <tr> <th rowspan="3">Scissor Brakes</th> <th colspan="6">Scissor Brake compatibilities on a 24" Rear Wheel</th> </tr> <tr> <th colspan="6">Rear Wheel Position</th> </tr> <tr> <th>1</th> <th>2</th> <th>3</th> <th>4</th> <th>5</th> <th>6</th> </tr> </thead> <tbody> <tr> <td>Seat Depth</td> <td></td> <td></td> <td></td> <td></td> <td></td> <td></td> </tr> <tr> <td>32cm-38cm</td> <td>N</td> <td>N</td> <td>N</td> <td>N</td> <td>Y</td> <td>Y</td> </tr> <tr> <td>40cm</td> <td>N</td> <td>N</td> <td>N</td> <td>N</td> <td>Y</td> <td>Y</td> </tr> <tr> <td>42cm</td> <td>N</td> <td>N</td> <td>N</td> <td>Y</td> <td>Y</td> <td>Y</td> </tr> <tr> <td>44cm</td> <td>N</td> <td>N</td> <td>Y</td> <td>Y</td> <td>Y</td> <td>Y</td> </tr> <tr> <td>46cm</td> <td>N</td> <td>Y</td> <td>Y</td> <td>Y</td> <td>Y</td> <td>Y</td> </tr> <tr> <td>48cm</td> <td>Y</td> <td>Y</td> <td>Y</td> <td>Y</td> <td>Y</td> <td>Y</td> </tr> <tr> <td>50cm</td> <td>Y</td> <td>Y</td> <td>Y</td> <td>Y</td> <td>Y</td> <td>Y</td> </tr> </tbody> </table>	Scissor Brakes	Scissor Brake compatibilities on a 24" Rear Wheel						Rear Wheel Position						1	2	3	4	5	6	Seat Depth							32cm-38cm	N	N	N	N	Y	Y	40cm	N	N	N	N	Y	Y	42cm	N	N	N	Y	Y	Y	44cm	N	N	Y	Y	Y	Y	46cm	N	Y	Y	Y	Y	Y	48cm	Y	Y	Y	Y	Y	Y	50cm	Y	Y	Y	Y	Y	Y	◆
Scissor Brakes	Scissor Brake compatibilities on a 24" Rear Wheel																																																																													
	Rear Wheel Position																																																																													
	1		2	3	4	5	6																																																																							
Seat Depth																																																																														
32cm-38cm	N		N	N	N	Y	Y																																																																							
40cm	N		N	N	N	Y	Y																																																																							
42cm	N	N	N	Y	Y	Y																																																																								
44cm	N	N	Y	Y	Y	Y																																																																								
46cm	N	Y	Y	Y	Y	Y																																																																								
48cm	Y	Y	Y	Y	Y	Y																																																																								
50cm	Y	Y	Y	Y	Y	Y																																																																								
DDU1301	Push brake lever straight	○																																																																												
DDU1302	Performance brake (NC: 1310)	€77																																																																												
DDU1303	Scissor/Active Brake (NC: 1310)	€77																																																																												
DDU1306	Pull brake	○																																																																												
DDU1399	Without brake Only available with DDA0927 wheel with integrated brake	○																																																																												
																																																																														
DRUM BRAKE (Specific complete wheel mounted with a black adapter plate) CPS if selected will not apply to this wheel option																																																																														
DDU1304	Attendant drum brake		€377																																																																											
BRAKE LEVER EXTENSION																																																																														
DDU1310	Brake lever extension		€44																																																																											
ANTI TIPPER Only 2 adaptions per side, adaptions include Anti tips, Tipper aid, Cane holder																																																																														
DDU1702	Anti tipper right		€127																																																																											
DDU1703	Anti tipper left		€127																																																																											
DDU1704	Anti tipper both sides		€254																																																																											
SEAT BELT																																																																														
DDU1730	Seat belt (NC: 1770)		€77																																																																											
DDU1770	Transportation kit includes seat belt and tie down labels		€77																																																																											
ACCESSORIES																																																																														
DDU1734	Mountain bike wheels with bag are supplied with aluminium handrims only, includes quick release axles		€288																																																																											
DDU1729	Rear frame protectors		€16																																																																											
DDU1739	Front frame protectors (Not compatible with high mounted footplates)		€33																																																																											
DDP1712	Kuschall watch mounted on right castor housing		€111																																																																											
DDP1713	Kuschall watch mounted on left castor housing		€111																																																																											
DDU1708	Tipper-Aid, right (NC: 1706,1719)		€43																																																																											
DDU1709	Tipper-Aid, left (NC: 1707,1719)		€43																																																																											
DDU1718	Tipper-Aid, both sides (NC: 1706,1707,1719)		€85																																																																											
DDU1706	Cane holder, right		€66																																																																											
DDU1707	Cane holder, left		€66																																																																											
DDU1719	Cane holder, both sides		€131																																																																											
MANUAL AIR PUMP																																																																														
DDU1715	Air pump		€12																																																																											
TOOL KIT																																																																														
DDU1717	Tool kit		◆																																																																											
PRICE																																																																														
			Total Price																																																																											

Non Conforming Items Guide	
DDU0118	28cm Seat width
DDU0120	30cm Seat width
DDU0249	Rear wheel extension
DDU0267	5th position
DDU0268	6th position
DDU0283	Camber 3°
DDU0703	Height adjustable, rear set
DDU0712	Angle adjustable backrest, adjusted 102°
DDU0734	Fold down back ( folding forward onto the seat )
DDU0750	Without push handles
DDU0820	6" Light wheel
DDU0821	6" Pneumatic Wheel
DDU0822	7" Light Wheel
DDU0906	24" Spinerger LXX Wheel
DDU0908	24" High Performance Wheel
DDU0910	Cross spoked
DDU0911	Radial spoked
DDU0915	22", 24", 26" küschall Starec
DDU0918	25" High Performance Wheel
DDU0927	609mm (24") Wheel with integrated brakes
DDU1001	22", 24", 26" Light wheel 7 bar
DDU1002	22", 24" Profile tyre 7 bar
DDU1004	24" Solid tyre, profil, grey
DDU1006	24" Solid tyre (KIK type), black
DDU1007	22", 24" Solid, light wheel
DDU1020	Anti flat tyre tube protection
DDU1102	22", 24", 26" Supergripp, dist. 3 cm
DDU1104	24", 26" Steel, dist. 3 cm
DDU1106	24" Titanium handrim
DDU1120	24", 25" Surge LT handrim
DDU1200	22", 24", 26" Transparent
DDU1202	24" Küschall Black with white logo
DDU1208	24" Transparent and white with Küschall logo in black
DDU1300	Push brake bent
DDU1302	Performance brake
DDU1304	Attendant drum brake
DDU1310	Brake lever extension
DDU1399	Without Brake
DDU1405	Mud guards carbon, fixed
DDU1411	Tubular Armrest
DDU1416	Siderest height adjustable (with tools), removable, short
DDU1421	Siderest height adjustable (with tools), removable, long
DDP1491	Backbrace swing away and removable
DDU1530	Heel loops
DDU1564	2 piece angle adjustable footplate set to front
DDU1565	2 piece angle adjustable footplate set back
DDU1702	Antitipper right
DDU1703	Antitipper left
DDU1706	Cane Holder Right
DDU1707	Cane Holder Left
DDU1719	Cane Holder both sides
DDU1770	Transportation kit includes seat belt and tie down labels (available on back heights of 405mm and above)





Please fill out the required measurements in the table if applicable and give full details of the special request in the space provided below.

---



---



---



---



---



---



---



---



---



---



---



---











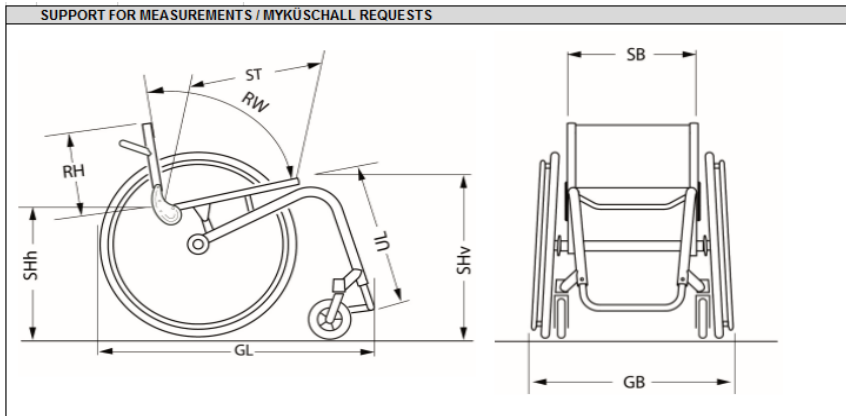



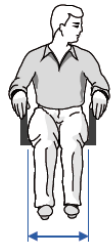



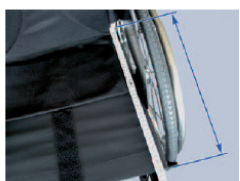

---

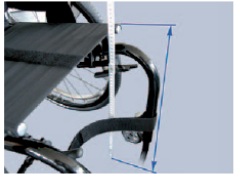

---

Customized Measurements	
Seat Width (SB)	
Seat Depth (ST)	
Back Height (RH)	
Front Seat Height (SHv)	
Rear Seat Height (SHh)	
Knee to Heel (UL)	
Backrest Angle (RW)	
Chair Length/ Chair Width (GL/GB)	
Client Weight	
Client Height	



	User measurement*	Wheelchair measurement
 <p><b>Seat width (SB)</b></p> <p>The seat width determines the user's comfort and performance. It must be wide enough to ensure good weight distribution, but narrow enough to allow easy manipulation of the wheelchair.</p>	 <ul style="list-style-type: none"> <li>Let the person sit on a flat surface.</li> <li>Position vertical blocks left and right of the hips and measure the distance between the blocks.</li> <li>Add approximately 2 cm to cater for winter clothing for the wheelchair measurement.</li> </ul>	 <ul style="list-style-type: none"> <li>Remove the seat cushion.</li> <li>Measure the distance between the outer edges of the seat cover at the rear of the wheelchair.</li> </ul> <p>Ultra-Light / Compact: For the seat width add 0,5 cm to the measured distance.</p>
 <p><b>Seat depth (ST)</b></p> <p>A correct seat depth measurement enables an even distribution of the user's weight across the whole seating base, thereby avoiding pressure points and skin irritation in the area behind the knee.</p>	 <ul style="list-style-type: none"> <li>Let the person sit on a flat surface.</li> <li>Measure the distance from the rear most point of the buttocks/lower back to the hollow at the back of the knee.</li> <li>Subtract approximately 4 cm (depending on user's physique and the legrest angle) to give the wheelchair measurement.</li> </ul>	 <ul style="list-style-type: none"> <li>Remove the seat cushion.</li> <li>Measure the distance from the front edge of the backrest tube (without upholstery) to the front edge of the seat cover.</li> </ul>
 <p><b>Leg length (UL)</b></p> <p>The leg length measurement establishes the correct height for the footplates, which will enable part of the body weight to be taken by the feet. Footplates must have at least 2 cm clearance above the ground.</p>	 <ul style="list-style-type: none"> <li>Let the person sit on a flat surface.</li> <li>Measure the distance from the heel of the shoe to the hollow at the back of the knee.</li> <li>Subtract any cushion thickness to give the wheelchair measurement.</li> </ul>	 <ul style="list-style-type: none"> <li>Remove the seat cushion.</li> <li>Measure the distance from the back edge of the footplate to the front edge of the seat cover (without sagging of cover).</li> </ul>
 <p><b>Front seat height (SHv)</b></p> <p>A correct seat height measurement will ensure the optimum driving efficiency and can give more clearance to fit underneath tables.</p>	 <ul style="list-style-type: none"> <li>Let the person sit on a flat surface.</li> <li>Measure the vertical distance from the ground to the hollow at the back of the knee.</li> <li>This measurement should not be less than the leg length (UL) + 4 cm to allow sufficient footplate clearance above the ground.</li> <li>Subtract any cushion thickness to give the front seat height (SHv) wheelchair measurement.</li> </ul>	 <ul style="list-style-type: none"> <li>Remove the seat cushion.</li> <li>Measure the vertical distance from the floor to the top of the front edge of the seat cover (without sagging of cover).</li> </ul>
 <p><b>Rear seat height (SHh)</b></p>	<ul style="list-style-type: none"> <li>Rear seat height is determined by the front seat height, the seat angle and the seat depth.</li> </ul>	 <ul style="list-style-type: none"> <li>Remove the seat cushion.</li> <li>Measure the vertical distance from the floor to the top of the rear edge of the seat cover (without sagging of cover).</li> </ul>
 <p><b>Backrest height (RH)</b></p> <p>The backrest height is dependent on the user's degree of disability. A correct backrest height should maintain a good posture whilst allowing the permitted freedom of movement.</p>	 <ul style="list-style-type: none"> <li>Let the person sit on a flat surface.</li> <li>Measure the vertical distance from the seat platform to the scapulas.</li> <li>If more trunk support is required, measure from the seat platform up to the required level of support.</li> <li>If less trunk support is required reduce the backrest height in order to improve activity.</li> </ul>	 <ul style="list-style-type: none"> <li>Remove the seat cushion.</li> <li>Remove back cover.</li> <li>Measure the distance from the top of the seat frame to the top of the backrest straps.</li> </ul>

\*To be done by a specially trained person