



Invacare[®] **Harrier XHD**[™]
User Guide



Yes, you can.[®]



Contents

Page

	Warranty Terms & Conditions	6
	Standard INVACARE Terms.....	6
	Limitation of liability.....	7
1	Useful Symbols In This Manual	5
2	Introduction	8
	2.1 Intended Use.....	9
	2.2 Type Classification.....	10
3	Safety Notes	11
	3.1 Repair or Service Information.....	11
	3.2 General Safety notes.....	12
	3.3 Safety Information On Electromagnetic Interference.....	14
	3.4 Safety Precautions/Safe Operation.....	15
4	Some Useful Tips	18
5	Safety Inspection Checklist	23
6	Trouble Shooting	26
	6.1 Trouble Shooting – Mechanical.....	26
	6.2 Trouble Shooting – Electrical.....	27
	6.3 Checking Battery Charge Level.....	29
	6.4 Care And Maintenance.....	30
	6.5 Product End of Life.....	30
7	Adjustment	31
	7.1 Seat Depth & Backrest Angle Adjustment (Manual).....	31

	7.2 Tension Adjustable Back Upholstery (where fitted).....	33
	7.3 Tray Assembly.....	34
	7.4 Installing Or Adjusting Lateral Supports (where fitted).....	35
	7.5 Lap Belt Adjustment.....	36
	7.6 Armrest Adjustment.....	38
	7.7 Installing/Removing Or Adjusting Headrest (where fitted).....	40
	7.8 Seating.....	41
	7.9 Installing/Removing Seat/Back Cushion (where fitted).....	41
	7.10 Installing/Removing Seat Board.....	42
	7.11 Kerb Climber.....	43
	7.12 Leg Rests.....	44
	7.13 Amputee Supports.....	45
	7.14 Anti Tippers.....	46
8	Batteries.....	47
	8.1 Removing/Installing.....	47
	8.2 Battery Transportation Strap.....	50
	8.3 Disconnecting Battery Cables.....	51
	8.4 Connecting Battery Cables.....	53
	8.5 Batteries And Charging.....	54
	8.6 Disposing & Recycling Of Used Batteries.....	57
9	Motor Locks, Wheels & Brakes.....	58
	9.1 Disengaging/Engaging Motor Lock Levers.....	58
	9.2 Drive Wheels.....	59
	9.3 Manual Parking Brakes.....	60
10	Transportation.....	61
	10.1 Disassembly and folding.....	63
11	Controls Systems.....	66

	11.1 Types Of User Control	66
	11.2 Joystick Mounting Hardware.....	67
12	Transfers.....	68
13	Keeping Your Chair In Good Condition.....	70
14	Fault Finding.....	72
15	Waste Electrical & Electronic Equipment (WEEE) Directive 2002/96/EC...	73
16	ISO 7176 Part 15 Requirements.....	74
	Contacting INVACARE.....	76

I Useful Symbols In This Manual



WARNING!

This symbol warns you of danger! Always follow the instructions to avoid injury to the user or damage to the product!



EXPLOSION HAZARD!

This symbol warns you of an explosion hazard, an example of which can be caused by excessive tyre pressure in a pneumatic tyre!

- *Always follow the instructions to avoid injury to the user or damage to the product.*



BURN HAZARD!

This symbol warns you of burns due, for example, to leaking battery acid.

- *Always follow the instructions to avoid injury to the user or damage to the product.*



NOTE:

This symbol identifies general information which is intended to simplify working with your product and which refers to special functions.



REQUIREMENTS:

This symbol identifies a list of various tools, components and items which you will need in order to carry out certain work.



TRANSPORTATION:

This symbol identifies important information relevant to transporting your powered wheelchair in a motor vehicle.

Warranty Terms & Conditions

Standard INVACARE Terms

This is to certify that your powered wheelchair is warranted by INVACARE Ltd. for a period of 2 years for parts, 3 years for frames and 12 months for batteries.

1. Only INVACARE chairs purchase at full price are warranted against defective workmanship and materials.
2. If a defect or fault is discovered the INVACARE dealer from whom the appliance was obtained should be notified immediately.
3. The manufacturer will not accept responsibility for damage caused by misuse or non-observance of the instructions set out in the user manual.
4. During the period of the warranty any parts that have become defective, due to faulty workmanship or materials, will be renewed or repaired without charge by the INVACARE dealer.
5. The warranty will be forfeited should any unauthorized alteration be made to the equipment.
6. The purchaser's statutory rights under the Consumer Protection Act are not affected.

Limitation Of Liability

This warranty does not extend the consequential costs from fault clearance, in particular freight and travel costs, loss of earnings, expenses, etc.

- Natural wear and tear
- Inappropriate or incorrect use
- Defective assembly or setting-up by the purchaser or third parties
- Defective or neglectful treatment
- Use of unsuitable spares

2 Introduction

Dear Customer,

First of all we wish to thank you for your confidence in our products. We hope you will enjoy your new Harrier XHD™ powered wheelchair.

This manual contains important information and hints on:

- **Safety**
- **Operation**
- **Care and maintenance**

The information contained in this document is subject to change without notice.

As a manufacturer of wheelchairs, INVACARE endeavours to supply a wide variety of wheelchairs to meet many needs of the customer. However, final selection of the type of wheelchair to be used by an individual rests solely with the user and his/her healthcare professional capable of making such a selection.

Do not operate this equipment without first reading and understanding this manual. If you are unable to understand the warnings, cautions, and instructions, contact your dealer otherwise injury or damage may result.

The initial set up of this wheelchair must be performed by an experienced technician.

Procedures other than those described in this manual **must** be performed by an experienced technician.



Note:

Not all of the components within this manual will necessarily be available with your powered wheelchair. Any references not applicable to your product should be ignored.

2.1 Intended Use

Indoor and outdoor configurable wheelchair offered with various options compliant with EN12184:2009 section 5 class B.

The Harrier XHD™ powered wheelchair has been designed to provide mobility and comfort for persons with impaired mobility.

The wheelchair has been designed to be used either/or by a seated user/carer/attendant in both indoor and outdoor environments.



The wheelchair has, in its standard format, been designed to accommodate users who have all limbs intact and have sufficient upper body strength to maintain a safe position within the wheelchair without the addition of supporting aids.



Adaptations from the standard wheelchair format are available to accommodate users who do not meet these criteria, these will only be considered after a suitable risk assessment has been carried out by the product prescriber. When prescribing wheelchairs for use by full or partial amputees (above or below knee, single or double) it is important to recognise that lower limb amputation will affect the sitting centre of balance of the wheelchair. The impossibility of generalising the individual ability of a wheelchair user means it is imperative that the product prescriber carries out a full stability evaluation to ensure that the user is safe in the use of the wheelchair and the risk of the wheelchair tipping is minimised.

The wheelchair should only be used in accordance with the safety advice given within this user guide. Failure to follow the recommended advice within this user guide could lead to personal injury.

2.2 Type Classification

Your powered wheelchair is a Class B (EN12184) and Class 2 (Road Traffic Act) available with a maximum speed of 4mph for use only on pavements, footpaths, pedestrian zones and areas free from motor traffic. It is not allowed on the highway except for the purpose of crossing. Under no circumstance must the top speed of the Powered wheelchair be increased, to do so will infringe the 'The Use of Invalid Carriages on Highways Regulations 1988, Statutory Instrument 1988 No. 2268'



WARNING!

WEIGHT LIMITATION – Your powered wheelchair has a maximum user weight limit of 160kg/25stone.

3 Safety Notes

3.1 Repair Or Service Information



Setup of the Electronic Control Unit is to be performed ONLY by an experienced technician. The final tuning adjustments of the controller may affect other activities of the wheelchair. Damage to the equipment could occur under these circumstances. Failure to adhere to the above statement will result in the warranty becoming void.



Limitation of Use

- **WEIGHT TRAINING** – INVACARE does not recommend the use of its wheelchairs as a weight training apparatus. INVACARE wheelchairs have not been designed or tested as a seat of any kind for weight training. If occupant uses their wheelchair as weight training apparatus, INVACARE shall not be liable for injury and the warranty will become void.
- Do not attempt to move up, down or traverse an incline with a water, ice or oil film.
- Do not attempt to drive over kerbs or obstacles greater than 5cm unless a kerb climber is fitted. Doing so may cause your wheelchair to turn over and cause bodily harm or damage to the chair.
- Do not climb, go up or down ramps or traverse slopes greater than 10°. The maximum safe slope is 10°.

3.2 General Safety Notes



GENERAL WARNINGS

- Performance adjustments should only be made by professionals of the health care field or persons fully conversant with this process and the driver's capabilities. Incorrect settings could cause injury to the driver, bystanders, damage to the chair and to surrounding property.
- After the wheelchair has been set up, check to ensure that the wheelchair performs to the specifications entered during the setup procedure. If the powered wheelchair does not perform to specifications, turn the wheelchair OFF immediately and re-enter setup specifications. Repeat this procedure until the wheelchair performs to specifications.
- Do not use parts, accessories or adapters other than those authorized by INVACARE.
- Do not stand on the frame of the wheelchair.
- Take care when disengaging automatic brakes if the chair is on a slope.



TYRE PRESSURE

- Do not use your wheelchair unless it has the proper tyre pressure. Do not over inflate the tyres. Failure to follow these suggestions may cause the tyre to explode and cause bodily harm. The recommended tyre pressure is listed on the wall of the tyre.



BATTERIES

- The warranty and performance specifications contained in this manual are based on the use of deep cycle gel cell batteries.
- Carefully read battery/battery charger information prior to installing, servicing or operating your powered wheelchair.



CLIMATIC TESTING

- INVACARE has tested its powered wheelchairs in accordance with ISO 7176 Part 9 'Climatic Test'. This provides the user or his/her attendant sufficient time to remove his/her power wheelchair from a rain storm and retain wheelchair operation.
- Do not leave powered wheelchair in a rain storm of any kind.
- Do not use powered wheelchair in a shower or leave it in a damp bathroom while taking a shower.
- Do not leave powered wheelchair in a damp area for any length of time.
- Direct exposure to rain or dampness will cause the chair to malfunction electrically and mechanically; may cause the chair to prematurely rust.
- Do not use the joystick if the boot is torn or cracked. If the joystick boot becomes torn or cracked, replace immediately.

3.3 Safety Information On Electromagnetic Interference

This electric vehicle was successfully tested in accordance with international standards as to its compliance with Electromagnetic Interference (EMI) regulations. However, electromagnetic fields, such as those generated by radio and television transmitters, and cellular phones, can influence the functions of the electric vehicles. Also, the electronics used in our vehicles can generate a low level of electromagnetic interference, which however will remain within the tolerances permitted by law. For these reasons we ask you to please observe the following precautions:



WARNING: DANGER OF MALFUNCTION DUE TO ELECTROMAGNETIC INTERFERENCE!

- Do not switch on or operate portable transceivers or communication devices (such as radio transceivers or cellular telephones) when the vehicle is switched on!
- Avoid getting too close to strong radio and television transmitters!
- In case the vehicle should be set in motion unintentionally or the breaks are released, switch it off immediately!
- Adding electrical accessories and other components or modifying the vehicle in any way can make it susceptible to electromagnetic interference. Keep in mind that there is no sure way to determine the effect such modifications will have on the overall immunity of the electronic system!
- Report all occurrences of unintentional movement of the vehicle, or release of the electronic brakes to the manufacturer!

3.4 Safety Precautions/Safe Operations

- The day to day activities and the more advanced powered wheelchair techniques depend, on your physical capabilities and your own specific circumstances. Our recommendations may occasionally differ from those of your therapeutic adviser or physician, as they may have a better understanding of your abilities. Where this is the case, you must follow their advice, they are better placed to tell you what is suitable for you and what is not.
- Do not use your powered wheelchair when your driving ability is impaired by medication or alcohol.
- Avoid using your powered wheelchair on rough ground or in adverse weather conditions (snow or ice), always steer clear of obstacles where possible, ensure your clothing and hands are kept clear of all moving parts, ask for assistance when descending or ascending steep gradients. Never attempt to negotiate stairs. Never use an escalator to move a powered wheelchair between floors. Due to both the weight of a powered wheelchair and its occupant it is not advisable to attempt to be assisted up and down stairs whilst the powered wheelchair is occupied.
- If you are a user with limited mobility we advise that in the case of adverse weather conditions, i.e. extreme cold, do not attempt a journey without an accompanying attendant. In an event of a power failure you could become stranded in an isolated area, where there is the strong possibility you will be unable to get immediate assistance.
- Braking of your powered wheelchair is dependant on electromagnetic motor brakes. When these are disengaged by declutching the motor gear box drive system, the chair is in freewheel mode, this mode is for emergency use only and motor gearboxes should remain engaged at all other times.
- To avoid the powered wheelchair free wheeling special care must be taken to engage motor brakes.
- When using your powered wheelchair indoors always consider the following potential hazards:
 - Beware of the fact that many of the premises where you are likely to use your powered wheelchair may not have been designed with this consideration in mind. You should therefore have an awareness for safety when encountering the likes of narrow doorways, steps, high surfaces, protruding wall fittings and every day household items such as electrical appliances, etc. Take extra care in kitchen environments.

Consider the fire evacuation procedures for buildings you may be entering. Never put yourself at risk, and ensure that you can be evacuated in the event of an emergency.



NOTE

Powered wheelchairs drive very quietly, generally travel faster than the average walking pace and are low to the ground. Always consider these factors when using your powered wheelchair in busy pedestrian areas.

- Coping with the irritation of everyday obstacles can be alleviated somewhat by learning how to manage your wheelchair. Keep in mind your centre of gravity to maintain stability and balance.
- When learning a new technique, have an experienced assistant help you before attempting it alone.

SAFETY/HANDLING OF WHEELCHAIRS



- Use this information only as a 'basic' guide. The techniques that are discussed on the following pages have been used successfully by many.
- Individual wheelchair users often develop skills to deal with daily living activities that may differ from those described in this manual. INVACARE recognises and encourages each individual to try what works best for him/her in overcoming environmental obstacles that they may encounter, however all warnings and cautions given in this manual must be followed. Techniques in this manual are a starting point for all new wheelchair user and assistant with 'safety' as the most important consideration for all.



RECOMMENDED DRIVING POSITION

- INVACARE recommends that when driving your powered wheelchair during normal operating conditions the following seat and back angles are maintained:
- Seat Angle: - approximately 4°
- Back Angle: - approximately 7°
- Failure to observe the above precautions whilst driving may lead to instability, damage to the chair, user or those around you.

SURFACES AFFECTED BY HEAT

The wheelchair is made from metal and plastic materials and, as with all products made with such materials, it can absorb heat from the sun when used outdoors or exposed to sunlight through windows, etc. This can result in the surfaces of the wheelchair becoming hot, so take care in using it and touching the surfaces if it is left or used in such an environment.

4

Some Useful Tips



- Before you venture off on your first journey, ensure that everything is adjusted to your specific needs, read this manual to familiarise yourself with the product and its functions. Do not attempt to drive without an attendant on hand until you are fully proficient in using and maneuvering your powered wheelchair.
- Ensure power is switched off before transferring to or leaving your powered wheelchair. Before switching on, check that both motors are engaged, tyres are inflated to the correct pressure and are in good condition. When on the move do not attempt turns at full speed, especially while traveling downhill. Before changing from forward to reverse, and vice versa, you must stop. Failure to do so will cause severe damage to the electronics. Do not use your powered wheelchair beyond its limitations.
- When entering or leaving your powered wheelchair, do not stand on the footplates.
- If you have to brake in an emergency, release the joystick. Do not switch off power while the powered wheelchair is moving, it would cause an abrupt, sharp stop.
- Do not use your powered wheelchair beyond the limitations set out in this manual concerning kerb height, gradients, etc.



STABILITY AND BALANCE

To ensure stability and safe control of your powered wheelchair you must at all times maintain proper balance. The powered wheelchair is designed to remain stable and upright during normal use, so long as you do not move your centre of gravity outside the normal seating position.



REACHING - BENDING FORWARD

- Ensure power is OFF. Do not lean your body forward out of the powered wheelchair further than the length of the armrests.
- Do not attempt to pick up objects from the floor by bending forward and reaching between your knees.
- Do not attempt to reach objects by sliding forward to the edge of the Powered wheelchair seat.



REACHING - BENDING BACKWARDS

- Again ensure power is switched OFF.
- Do not reach back any further than your arm will extend without changing your sitting position.
- Do not lean over the top of the backrest as it will shift the centre of gravity, risking tipping over.
- Do not hang heavy loads or objects on the backrest. They may make the powered wheelchair unstable, especially on an incline.

TRANSFERRING TO AND FROM OTHER SEATS

- Always turn the wheelchair power OFF and engage the motor locks/clutches to prevent the wheels from moving before attempting to transfer in or out of the wheelchair. Also, make sure every precaution is taken to reduce the gap distance by turning both front castors away from the object you are transferring onto.
- When transferring, position yourself as far back as possible in the seat. This will prevent broken screws, damaged upholstery and the possibility of the wheelchair tipping forward.
- Note: This activity may be performed independently provided you have adequate mobility and upper body strength.
- Position the wheelchair as close as possible along side the seat to which you are transferring, with the rear wheels pointing away from it.
- Shift body weight into seat with transfer.
- During independent transfer, little or no seat platform will be beneath you. Use transfer board if at all possible.



NEGOTIATING KERBS

When approaching kerbs wherever possible mount and dismount pavements via ramps. Always approach the kerb head on, not at an angle.

Without a Kerb Climber

Your Powered wheelchair can safely climb kerbs of up to 5cm without a kerb climber. Before negotiating the kerb, ensure the speed control setting is set to maximum. As the front wheels are about to make contact with the kerb push the joystick fully forward and hold it there until both front and rear wheels have climbed the kerbstone.

With a Kerb Climber

If a kerb climber (optional) is fitted, your powered wheelchair can safely climb kerbs of up to 10cm. Before negotiating the kerb ensure the speed control setting is set to maximum and the kerb climber is in the engaged position (facing forward). As the kerb climber makes contact with the kerb push the joystick fully forward and hold it there until both rear wheels have climbed the kerbstone. Your powered wheelchair prescriber will provide you with a demonstration and instructions on fitting.

If the kerb climb is unachievable do not continue the maneuver, move away from the obstacle and if possible find an alternate location.

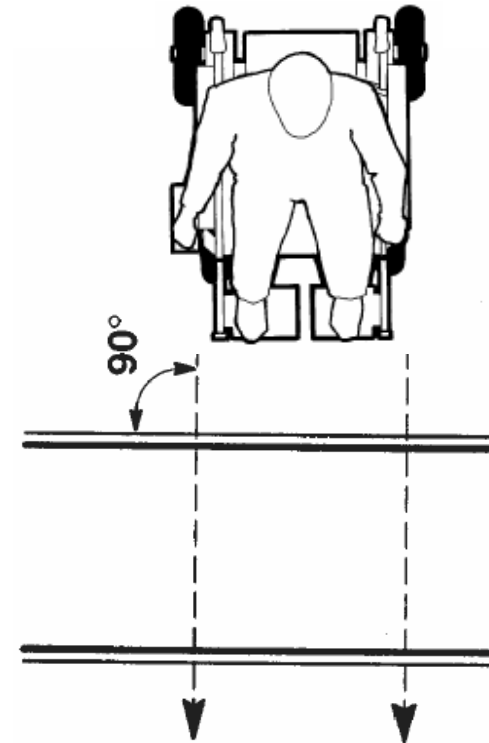

Descending a Kerb

1. Do not descend kerbs over 10cm.
2. Approach the edge of the kerb square on.
3. Look out for traffic.
4. Drive forward down the kerb.

The kerb climbing device should return to the climbing position after each maneuver. If you require further advice, please contact your INVACARE dealer.

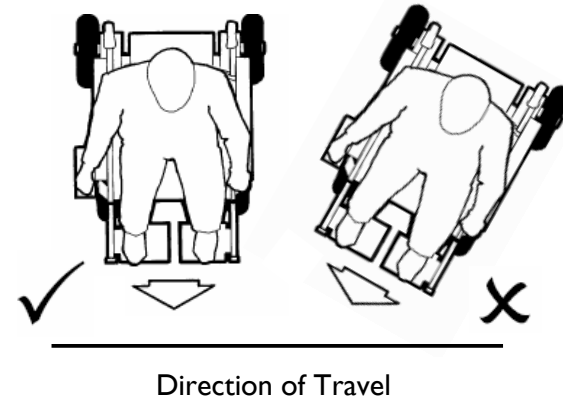

NEGOTIATING GRADIENTS/SLOPES

- The maximum safe slope is 9°.
- Never attempt to climb or descend an incline where the surface is rough, wet or slippery (gravel, loose chippings, grass, rain, black ice, snow, etc.).
- If you are in a situation where by the powered wheelchair fails to climb a ramp and stalls midway through the ascent, do not attempt to turn the powered wheelchair to drive back down in a forward facing direction, always reverse slowly in a steady, flowing action and do not brake harshly, as this will upset balance in this situation. If possible, always seek the assistance of an attendant.



YOU, YOUR POWERED WHEELCHAIR & OTHERS

- Powered wheelchairs are strictly forbidden on motorways and highways with fast moving traffic (please refer to section 2.2 'Type Classification').
- On the pavement, in pedestrian zones or in supermarkets it is obvious that you must show as much consideration and common sense to others as you expect from them.
- When you cross the carriageway of a public road take extra care and allow time to cross, observe the highway code. Although you are not required by law to hold a driving license, you are responsible and fully liable for proper operation. An important fact to bear in mind is that you must not present a traffic hazard even in the event of a breakdown. The most common cause may be discharged batteries. It is important to keep the batteries in a fully charged condition; we can only repeat this warning at this stage. If you do suffer a breakdown for whatever reason, you should immediately: seek the assistance of a passer-by. Explain where to find the motor disengagement/declutching lever, ask him/her to switch to freewheel, so that the Powered wheelchair can be pushed by hand and moved. When in a safe place always ensure motor gear boxes are re-engaged.

SAFEGUARDING OTHERS

- We want you to get the most out of your INVACARE powered wheelchair, ensuring that the safety of yourself and others is never in jeopardy. If you are in any doubt about safe techniques, handling or care of the powered wheelchair, contact a recognised expert before putting yourself and others at risk.

5 Safety Inspection Checklist

Initial adjustments should be made to suit personal body structure/user capability and preference. Thereafter follow these maintenance procedures:

	Initially	Inspect / Adjust Weekly	Inspect / Adjust Monthly	Inspect / Adjust 6 Monthly
General				
Wheelchair rolls straight (no excessive drag or pull to one side)	X			X
Electrics				
Plug and socket connections	X	X		X
Batteries have been fully charged before use of the chair	X			X
Supporting brackets and fasteners are not loose	X	X		X
Check cables for damage			X	X
Clothing guards				
Ensure no fasteners are loose	X			X
Arms				
Secure but easy to release; adjustment handwheels engage properly	X			X

	Initially	Inspect / Adjust Weekly	Inspect / Adjust Monthly	Inspect / Adjust 6 Monthly
Adjustable height arms operate and lock securely	X		X	X
Armrests				
Inspect for rips in upholstery	X			X
Arm rest pad sits flush against arm tube	X			X
Seat and back Upholstery				
Inspect for rips or sagging	X			X
Drive Wheels				
Ensure axle nut and wheel mountings are not loose	X		X	X
No excessive side movement or binding when lifted and spun when disengaged (free spinning)	X			X
Tyres				
Inspect for flat spots and wear	X	X		X
If pneumatic tyres check for proper inflation	X	X		X
Cleaning				
Clean upholstery and armrest	X	X		X

	Initially	Inspect / Adjust Weekly	Inspect / Adjust Monthly	Inspect / Adjust 6 Monthly
Castors				
Inspect wheel/fork assembly for proper tension by spinning castor; castor should come to a gradual stop Loosen/tighten locknut if wheel wobbles noticeably or binds to a stop CAUTION: As with any vehicle, the wheels and tyres should be checked periodically for cracks and wear, and should be replaced	X	X		X
Castor/Wheel/Fork/Head tube				
Ensure no fasteners are loose	X	X		X
Parking Brake Efficiency				
Ensure no fasteners are loose & brake operates efficiently	X		X	X



NOTE:

It is important for regular inspection to be carried out on seat/backrest upholstery, headrest and lap belt. The product must not be used if there is any visible damage (e.g. rips tears, fraying) to these parts. If you have any doubts regarding the condition of any part, do not hesitate to contact your INVACARE supplier/dealer immediately. Have your vehicle checked annually by an authorised INVACARE dealer in order to maintain its driving safety and roadworthiness.

6.1 Trouble Shooting - Mechanical

Initial adjustments should be made to suit personal body structure/user capability and preference. Thereafter follow these maintenance procedures:

Chair Veers Left/Right	Sluggish Turn / Performance	Castors 'flutter'	Squeaks & Rattles	Solutions
X	X	X		If pneumatic, check tyres for correct and equal pressure
X	X	X	X	Check for loose stem nuts/bolts
	X		X	Check that both castors contact ground at the same time

Looseness In Chair	Chair '3 Wheels'	Solutions
X		If pneumatic, check tyres for correct and equal pressure
	X	Check for loose stem nuts/bolts

6.2 Trouble Shooting - Electrical

Initial adjustments should be made to suit personal body structure/user capability and preference. Thereafter follow these maintenance procedures:

Symptom	Probable Cause	Solutions
Batteries draw excessive current when charging	Battery failure Electrical malfunction	Replace if necessary (see section 8) Contact Dealer/INVACARE for service
Battery indicator flashes the charge level is low immediately after charging	Battery failure Malfunctioning battery charger Electrical malfunction	Replace if necessary (see section 8) Contact Dealer/INVACARE for service Poor connections between charger and wheelchair. Contact Dealer/INVACARE
Battery indicator flashes the charge level is low too soon after being recharged	Batteries not charged Weak batteries	Have charger checked Replace batteries if necessary. Contact Dealer/ INVACARE for service
Motor 'chatters' or runs irregular	Electrical malfunction	Contact Dealer/INVACARE for service
Only one (1) drive wheel turns	Electrical malfunction One motor lock is disengaged	Contact Dealer/INVACARE for service Engage motor lock (see section 9.1)

Symptom	Probable Cause	Solutions
Joystick erratic or does not respond as desired	Damaged motor coupling	Contact Dealer/INVACARE for service
	Electrical malfunction	Contact Dealer/ INVACARE for service
Wheelchair does not respond to commands. Power indicator OFF – even after recharging	Controller programmed improperly	Contact Dealer/ INVACARE for service
	Poor battery terminal connection	Clean terminals (see section 8)
	Electrical malfunction	Contact Dealer/ INVACARE for service
	Blown/tripped fuse	Replace/reset the fuse (see section 8)



NOTE:

For additional troubleshooting information and explanation of electrical symptoms, refer to additional sections in this procedure of the manual.

6.3 Checking Battery Charge Level

The following 'Do's' and 'Don'ts' are provided for your convenience and safety.



Don'ts	Do's
Don't perform any installation or maintenance without first reading this manual.	Read and understand this manual and any service information that accompanies a battery and charger before operating the wheelchair
Don't make it a habit to discharge batteries to the lowest level.	Recharge as frequently as possible to maintain a high charge level and extend battery life
Don't use randomly chosen batteries or chargers	Follow recommendations in this manual when selecting a battery or charger
Don't put new batteries into service before charging	Fully charge a new battery before its first use
Don't tap on clamps and terminals with tools	Push battery clamps on terminals. Spread clamps wider if necessary
Don't mismatch your battery and chargers	Use only a GEL charger for a GEL or sealed battery
	Replace both batteries when failure occurs

6.4 Care & Maintenance



NOTE:

Have your vehicle checked at least once a year by an authorised INVACARE dealer in order to maintain its driving safety and roadworthiness.

Cleaning the vehicle:

When cleaning the vehicle, pay attention to the following points:

- Only use a damp cloth and gentle detergent.
- Do not use any scrubbing agents.
- Do not subject the electronic components to any direct contact with water.
- Do not use high-pressure cleaning devices.

6.5 Product End of Life

Even though your powered wheelchair has been designed to provide a long and trouble free life it is inevitable that wear, tear and usage will eventually render the product unusable.

- INVACARE recommends that the average usable life of this product is five years, providing the product has been correctly maintained according to the manufacturer's recommendations.

When the time comes to replace your powered wheelchair please remember to dispose of the product responsibly and recycle any recyclable parts as mentioned in this user guide.

7 Adjustment

7.1 Seat Depth & Backrest Angle Adjustment (Manual)

ADJUSTING:

The backrest has 3.5cm of depth adjustment and 12° of tilt adjustment (where applicable). The individual fitting of the firm backrest allows the seat depth to be adjusted by 3.5cm. The backrest angle can be adjusted from the vertical through to 12°.



SEAT DEPTH ADJUSTMENT:

1. Unscrew and remove the four bolts (A) and nuts from the backrest mounting brackets.
2. Move the backrest into the desired position.
3. Replace the four bolts and nuts into the mounting bracket and frame and firmly fasten.



BACKREST ANGLE ADJUSTMENT:

1. Release the lock nut (B) located on the cross-headed screw.
2. Screw the locking screw (C) partially out under thumb pressure.
3. Screw the cross headed screw in or out to give the desired back angle position.
4. Adjust the position of locking screw knob as necessary.
5. Position the lock nut up to the hinge bracket and fully tighten.
6. Re-tighten locking screw knob (C) fully, ensure backrest assembly is secure.

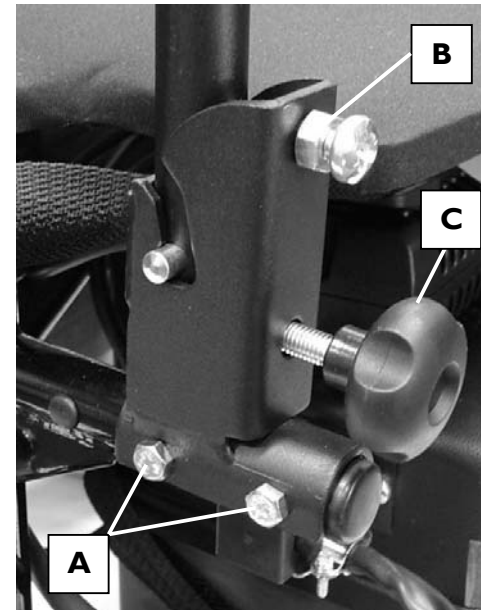



NOTE:

Each backrest post must be positioned in the same plane as the other or the backrest will be twisted. To enable the chair to be more portable, the backrest can be either folded down or detached from the wheelchair base.



TO FOLD THE BACKREST:

1. Unscrew the locking screw knob (C) approximately five full turns. Lift the backrest upwards and then fold forwards onto the seat.
2. To detach, unscrew the locking screw knob an additional three full turns. Do not loosen the cross-headed screw.
3. Push the backrest slightly forward and lift upwards.
4. To re-locate the backrest, ensure the pins align into the slots of the hinge bracket, fully re-tighten the locking screw knobs on both sides.

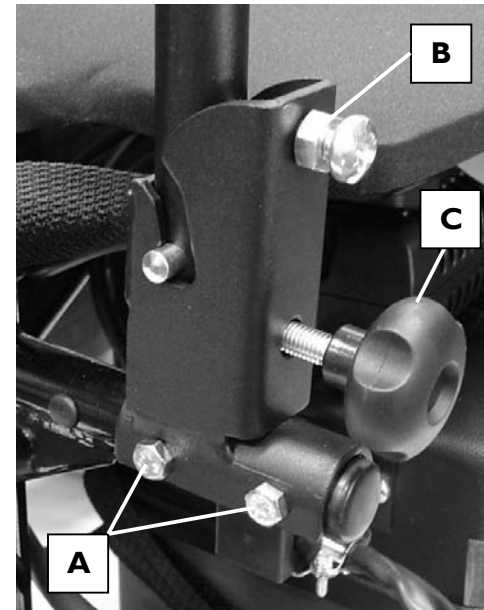

7.2 Adjusting Tension Adjustable Back Upholstery (where fitted)



CAUTION:

This adjustment should only be made when the chair is unoccupied and the joystick unit is switched off.

1. Remove backrest cushion by releasing the hook and loop fastening strips.
2. Adjust the tension of each belt by releasing the hook and loop fastening strips and repositioning as desired.



CAUTION:

Be sure that each belt is secured before sitting in the chair.



A chair fitted with a tension adjustable back can be used as a seat in transport. (See section 10 for further information).



7.3 Tray Assembly



IMPORTANT:

Ensure that the joystick control unit is switched off before fitting, removing or adjusting the tray assembly.

The tray assembly comes ready assembled and is designed to fit to either the left or right hand side of the wheelchair. The cut-out section is to accommodate the joystick control unit and determines which side the tray is fitted i.e. joystick control fitted to the right hand side, therefore the tray fixings will be fitted to the left hand side, and vice-versa.



WIDTH ADJUSTMENT:

1. Loosen the fixing bolt (A) and position the tray to its desired location.
2. Tighten fixing bolt (A).



DEPTH ADJUSTMENT:

1. Loosen handwheel (B) and position the tray to its desired depth.
2. Tighten handwheel (B).



HEIGHT ADJUSTMENT:

1. Loosen fixing bolts (A & C) and position the tray to its desired height.
2. Tighten fixing bolts (A & C).

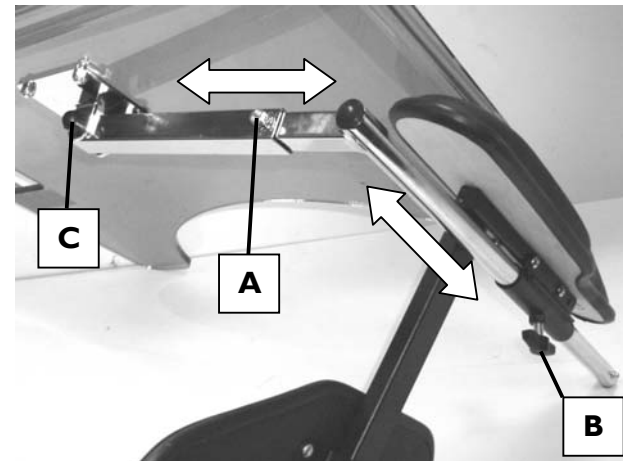

7.4 Installing Or Adjusting Lateral Supports (where fitted)



INSTALLING:

1. Remove the required existing pan head screws from each backrest flange.
2. Line up the support rail (A) with the holes in the backrest.
3. With the longer screws provided attach the support rail to the backrest flanges and into the screw inserts – DO NOT screw into the backboard.
4. Tighten securely, but do not over tighten.



ADJUSTING:

1. Slide the lateral support into the support rail from the bottom. Adjust to suit, and then firmly tighten the hand wheel (B).

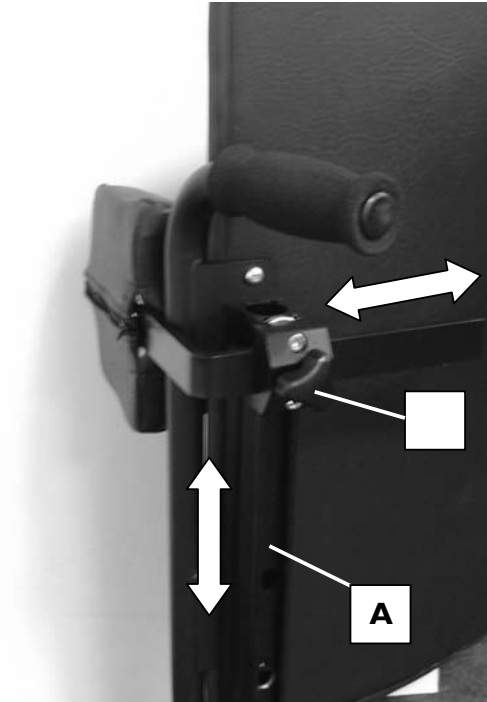

7.5



Lap Belts

TYPES OF LAPBELT:

The lap belt is commonly used to assist wheelchair users to maintain an optimal sitting posture. Correct use of the lap belt is intended to help the user, especially those with limited sitting balance, to remain safe, comfortable and well positioned in their wheelchair. Your wheelchair will be factory fitted with one of the following types of lap belt. Please note however, that this may have been replaced with an alternative by your therapist to meet your requirements. If an alternative lap belt or harness etc. has been fitted please ensure you are provided with the manufacturers written instructions for fitting and safe usage.

'Plastic buckle belt' – Adjustment is possible on both sides will allow the buckle to remain in a central position.



'Metal buckle belt' – with single adjuster - Adjustment is only possible on one side. This may result in the buckle being off-centre.



'Metal buckle belt' – with double adjuster - Adjustment is possible on both sides will allow the buckle to remain in a central position.



METHOD OF ADJUSTMENT:

Ensure you are sitting correctly, i.e. fully back in the seat, and the pelvis is as upright and symmetrical as possible – not forward on one side or tilted back.

Position the lap belt so that the hip bones can be felt above the belt.

Adjust the length of the lap belt using the buckle(s). As a guide, adjust the length so that there is just sufficient room for your hand to slide between your body and the belt. For ease of use it is recommended that the clasp is kept in a central position where possible i.e. make adjustments to each side.

Please check your lap belt every week to ensure that it is in good condition, i.e. no damage, fraying etc. and that it is securely fixed to the wheelchair.



WARNING:

If it is intended that your wheelchair is to be used as a seat for transportation in a vehicle INVACARE recommend the use of a metal buckled type lap belt (please check that your wheelchair has been tested to ISO 7176 part 19 – refer to transportation section of this user manual).

During transportation the user should be restrained independently of the wheelchair by a suitably approved restraint system, the lap belt should be used in addition to but never as a substitute for an approved passenger restraint system.

7.6 Armrest Adjustment



CAUTION:

Ensure the controller power is switched off before making armrest adjustments.

The armrests are not intended for lifting/carrying the wheelchair.



ARMREST HEIGHT ADJUSTMENT:

1. Pre set the height of the armrest assembly by positioning the self tapping screw (B) in one of the holes in the armrest tube.
2. To adjust the height of each armrest, release the locking handwheel (A) which clamps the arm tube, while holding on to the armrest.
3. Move the armrest to the desired height and re-tighten the locking handwheel (A).
4. To set the side panel to the desired height, loosen the grub screw (C) located in the fixing bracket; re-tighten when in the correct position.

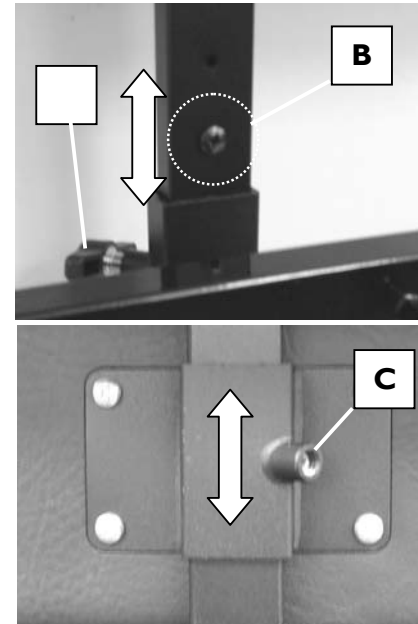

ARMREST WIDTH ADJUSTMENT:

1. Release locking handwheel (A) to allow the armrest assembly to slide out.
2. Set armrest assembly to the desired position and re-tighten the locking handwheel (A).

TO REMOVE THE ARMREST:

3. Release locking handwheel (A) to allow the armrest assembly to slide out.
4. Press in spring retaining clip (B) to allow the armrest to be removed.

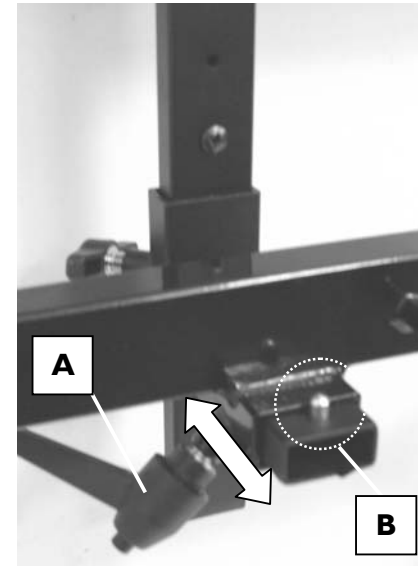

7.7 Installing / Removing Or Adjusting Headrest (where fitted)



CAUTION:

After any adjustments, repair or service and before use, make sure that all attaching hardware is tightened securely - otherwise injury or damage may result.



INSTALLING:

1. Ensure set screws are not protruding into headrest support tube.
2. Insert headrest assembly into headrest support tube.
3. Tighten the handwheel (A) to secure.



REMOVAL:

1. Loosen the handwheel (A).
2. Remove headrest assembly from headrest support tube.



ADJUSTING:

1. Loosen the headrest handwheels (A & B).
2. Adjust to desired position.
3. Re-tighten handwheels.



NOTE:

Ensure all headrest assembly adjustment screws, nuts and handwheels are tightened before using the wheelchair.

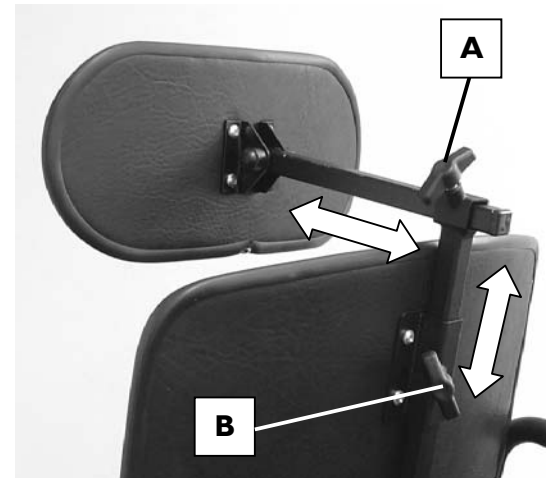

7.8 Seating



WARNING

- After any adjustments, repair or service and before use, make sure that all attaching hardware is tightened securely - otherwise injury or damage may result.
- It is important for regular inspection to be carried out on the armrests for signs of visible damage. If any repairs are required, these should be carried out by an INVACARE dealer.

7.9 Installing / Removing Seat / Back Cushion (where fitted)



CAUTION:

This adjustment should only be made when the chair is unoccupied and the joystick unit switched off.



NOTE:

The cushion inner may be removed from the upholstered cover by sliding it out from cover flap on the underside of the cushion.

1. Ensure the hook and loop fastener strip on the seat/back is visible (remove covering strip if necessary).
2. Position the cushion on the seat in the desired location and push down to secure.
3. To remove, pull up on cushion to release the hook and loop fastening. Remove cushion from seat.

7.10 Installing / Removing Seat Board



WARNING:

This adjustment should only be performed when the wheelchair is unoccupied. Take care not to damage any accessories fitted to the seat board.



To install/remove the seat board from the wheelchair seat frame:

1. Remove the seat cushion.
2. Remove the four 'R' clips (A) that secure the seat board to the seat frame.
3. Install / Remove the seat board.
4. Replace 'R' clips (A). Ensure the clip is pushed fully into position.

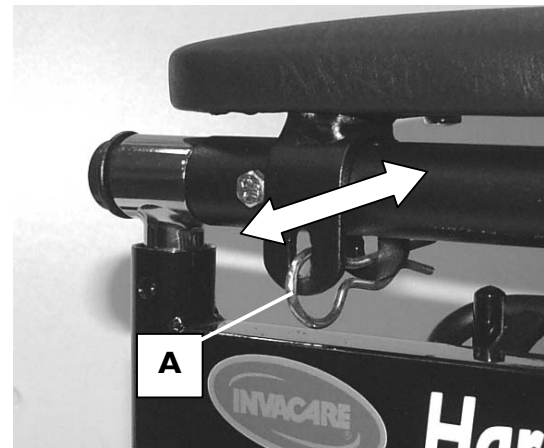

NOTE:

Ensure the seat board is firmly secured before fitting the cushion or using the wheelchair.

7.11 Kerb Climber



REMOVAL:

1. Remove the legrests, or swing them out of the way.
2. Loosen the handwheel (A) and then slide the handwheel towards the centre of the chair.
3. Pull the kerb climber assembly away from the retaining socket on the right hand side.



INSTALLING:

1. Locate the kerb climber into the right hand retaining socket.
2. Slide the handwheel (A) outwards until the assembly is also fitted into the left hand retaining socket.
3. Tighten the handwheel (A) firmly.

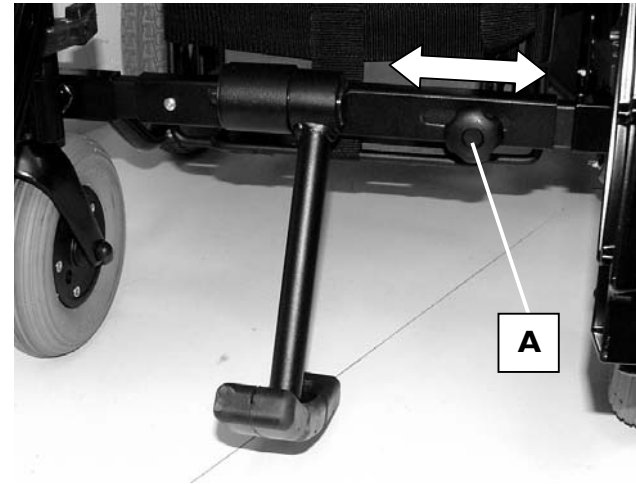

7.12



Leg Rests

REMOVAL:

Release locking lever (A), swing footrest to the side, or lift up and off. Do this before sitting in the chair.



ADJUSTMENT:

1. Loosen the hex nuts on the extension tube. Use a twisting motion when sliding the telescopic tube in and out.
2. Be sure to retighten the nuts securely when the desired height is achieved.



CAUTION:

The lowest part of the footplate must be at least 6cm from the ground for clearance. Never stand on the footplates. If the weight of the body is placed on the footplates it is possible the chair will tip forwards.

When using the lift facility, ensure that the footrests are removed from the chair.

It is recommended that both footrests are firmly locked into place when seated in the chair (particularly when driving the chair). Failure to do so may result in personal injury.

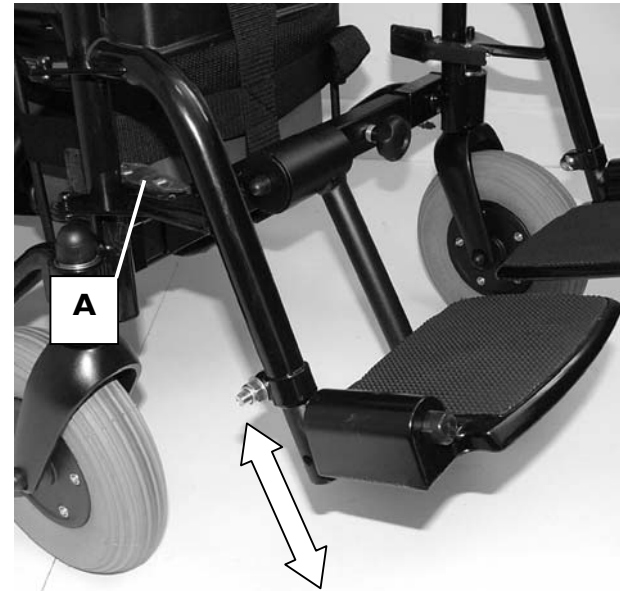

7.13 Amputee Supports



REMOVAL:

Release locking lever (A), swing support to the side, or lift up and off. Do this before sitting in the chair.



ADJUSTMENT:

1. To change height of the support pad loosen the locking wheel (B), adjust height to suit and then tighten the locking wheel (B).



CAUTION:

It is recommended that supports are firmly locked into place when seated in the chair (particularly when driving the chair). Failure to do so may result in personal injury.

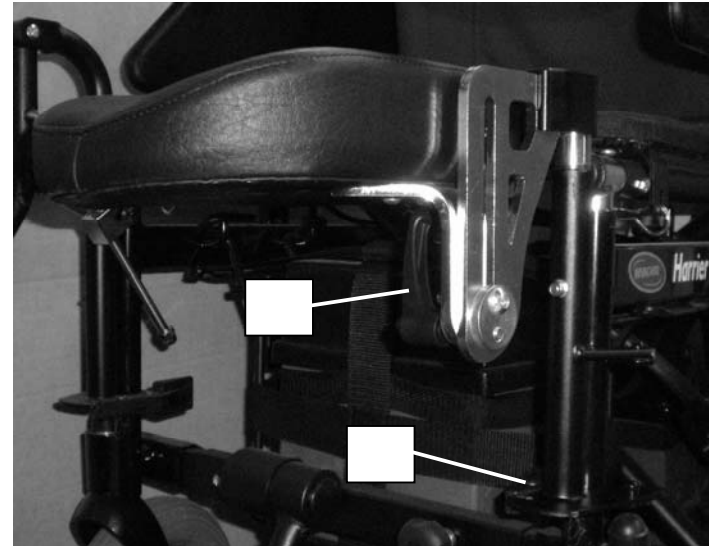

7.14 Anti Tippers



WARNING:

- After any adjustments or service and before use, make sure that all the attaching hardware is tightened securely – otherwise injury or damage may result.
- The anti tipping castors, or 'anti tippers', are an important safety feature on the Harrier XHD™ wheelchair. Do not attempt to drive the power chair if they have been removed or damaged.



NOTE:

Take care when mounting or dismounting a kerb. It may be possible to lose drive if the anti tipping castors contact the ground.



8



Batteries

WARNING:

- Make sure power to the wheelchair is OFF before performing this procedure.
- The use of rubber gloves and chemical goggles is recommended when working with batteries.
- INVACARE strongly recommends that battery installation and battery replacement always be carried out by an experienced technician.
- After any adjustments, repair or service and before use, make sure all attaching hardware is tightened securely - otherwise injury or damage may result.
- This procedure must be performed while the wheelchair is unoccupied.

8.1



Removing / Installing Batteries

WARNING:

- Each battery can weigh up to 15kg. Use proper lifting techniques (lift with your legs) to avoid injury.
- Failure to use the correct battery size and/or voltage may cause damage to your wheelchair and give you unsatisfactory performance. Only use INVACARE batteries.
- Always use a battery lifting strap when lifting a battery. It also helps to prolong the life of the battery.

The batteries fitted to your INVACARE powered wheelchair are not designed to be removed frequently and therefore the following procedure should only be carried out during service or repair of the wheelchair.



REMOVING:

1. Ensure the joystick is switched off.
2. Follow the steps in section 7.10 to remove the seat board.
3. Remove the battery transportation strap.
4. Disconnect both rear battery box wiring harnesses (red and grey connectors).
5. If fitted with a power module, disconnect all power, motor and joystick connectors.
6. Disconnect front and rear battery box fixing straps.
7. Remove batteries being sure to use proper lifting technique.

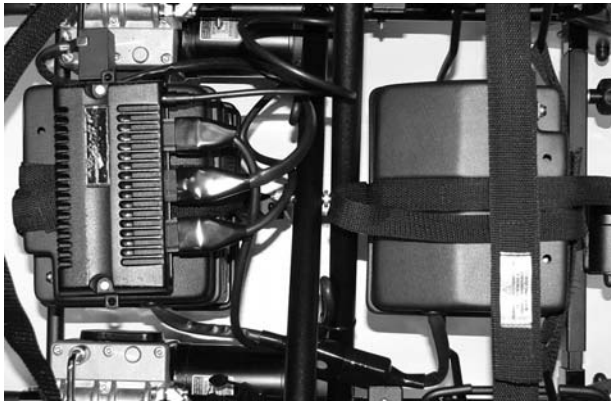



INSTALLING:

1. Place the batteries into the battery hangers being sure to use proper lifting technique.
2. Reconnect front and rear battery box fixing straps, and battery transportation strap.
3. If fitted with a power module reconnect all power, motor and joystick connectors
4. Reconnect battery box wiring harnesses (red and grey connectors).
5. Follow the steps in section 8.2 to replace the battery transportation strap
6. Follow the steps in section 7.10 to replace and secure the seat board.

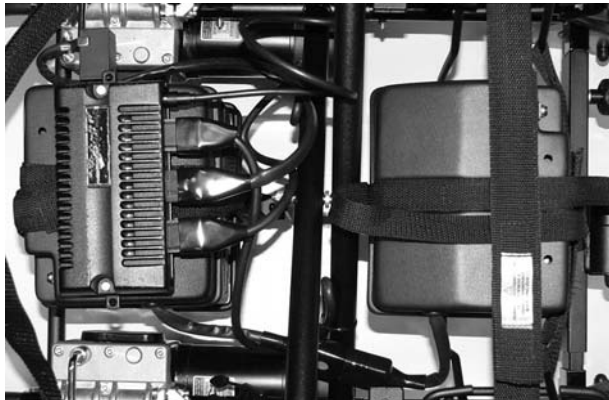

8.2 Battery Transportation Strap

If the batteries have been removed or replaced, following installation back into the chair the battery transportation strap must be replaced. The battery transportation strap is required if you intend to use your powered wheelchair as a seat in transport in a vehicle.

1. Feed the two shorter front straps around the front battery cradle, securing the buckle at the rear of the front battery. Adjust the straps to ensure a tight fitment.
2. Position the cross section of the battery transportation strap around the front battery.
3. Feed the two shorter front straps around the front battery cradle, securing the buckle at the rear of the front battery. Adjust the straps to ensure a tight fitment.
4. Release velcro of the front transportation strap.
5. Place the metal clips webbing in between the front transportation strap.
6. Secure the velcro of the front transportation strap around the metal clips webbing.
7. Feed the longer strap from underneath the rear of your powered wheelchair.
8. Secure the buckle of the longer strap over the top of power module & batteries. Adjust the strap to ensure a tight fitment.

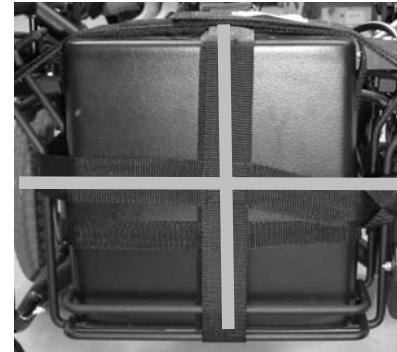

8.3 Disconnecting Battery Cables



WARNING:

- NEVER allow any of your tools and/or battery cable(s) to contact BOTH battery terminal(s)/ post(s) at the same time. An electrical short may occur and serious personal injury or damage may occur.
- The use of rubber gloves and chemical goggles is recommended when working with batteries.



NOTE:

Perform this procedure on one (1) battery and battery box at a time. Repeat procedure for other battery box.

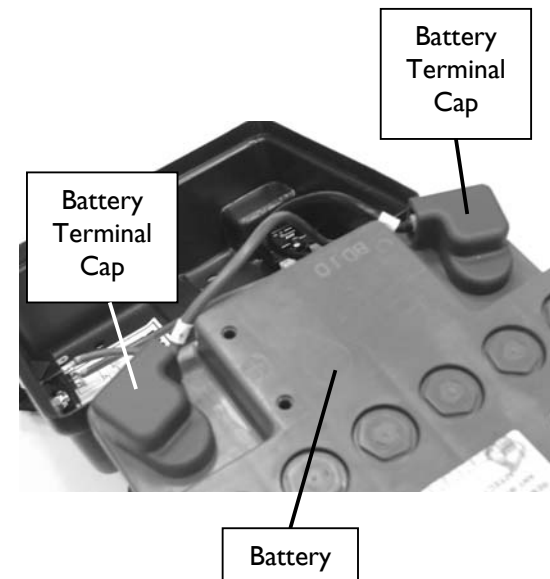



DISCONNECTING BATTERY CABLES:

1. Place the battery boxes in a well ventilated area where work can be performed without risking damage to carpeting or floor covering.
2. Disconnect strap and lift up on battery box lid to expose underlying cables.
3. Remove the hex screw and locknut that secures the **NEGATIVE (-)** black battery cable to the negative battery terminal/post.
4. Remove the hex screw and locknut that secures the **POSITIVE (+)** red battery cable to the positive battery terminal/post.

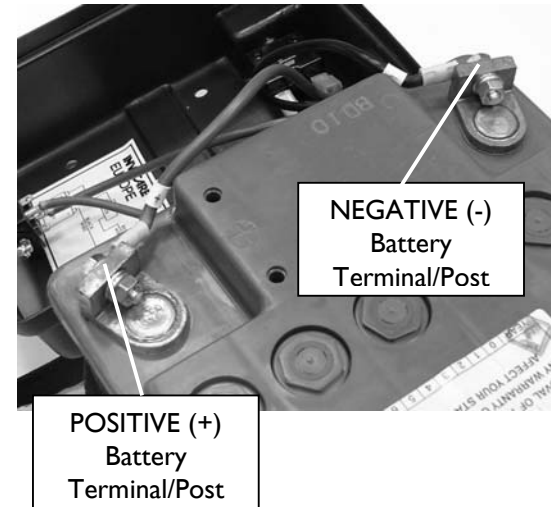

8.4 Connecting Battery Cables



WARNING:

- NEVER allow any of your tools and/or battery cable(s) to contact BOTH battery terminal(s)/ post(s) at the same time. An electrical short may occur and serious personal injury or damage may occur.
- The use of rubber gloves and chemical goggles is recommended when working with batteries.



CAUTION:

When connecting the battery cables to the battery (s), the battery cable(s) must be connected to the battery terminal(s)/post(s) depending on battery type. ALWAYS check the battery top for POSITIVE (+) and NEGATIVE (-) marking symbols before connecting the battery cables.



1. Connect battery cable(s) to battery (s) terminal(s)/post(s) as follows.
 - Negative (-) BLACK battery cable to NEGATIVE (-) battery terminal/post.
 - Positive (+) RED battery cable to POSITIVE (+) battery terminal/post.
2. Secure the battery cable(s)/ring terminal(s) to the battery terminal(s)/post(s), BLACK to NEGATIVE (-) and RED to POSITIVE (+), with the provided M6 hex screw, hex locknut and washer. Securely tighten.
3. Verify all battery cable(s)/ring terminal(s) are correctly installed and securely tightened.
4. Slide terminal cap(s) onto battery clamps / terminals.
5. Reassemble the battery box and install into the wheelchair.



NOTE:

New Battery (s) must be fully charged before using; otherwise the life of the battery (s) will be reduced.

6. If necessary, charge the battery (s). Refer to section 8.5 'Batteries & Charging'.

8.5 Batteries & Charging



WARNING:

- The battery charger supplied with your powered wheelchair is for indoor use only; it must be protected from moisture and external heat sources.
- Handle the battery charger with care, if it has been dropped or damaged, do not use it.
- Do not use an extension lead for connection from the mains to the charger unless absolutely necessary. If you do use one ensure it is in good condition.
- Only use the charger supplied with your powered wheelchair.
- Batteries are heavy, if you have to remove them, ensure you adopt the correct lifting posture to avoid injury. Ask for assistance if necessary.



WARNING:

- The battery charger supplied with your powered wheelchair is for indoor use only; it must be protected from moisture and external heat sources.
- Handle the battery charger with care, if it has been dropped or damaged, do not use it.
- Do not use an extension lead for connection from the mains to the charger unless absolutely necessary. If you do use one ensure it is in good condition.
- Only use the charger supplied with your powered wheelchair.
- Batteries are heavy, if you have to remove them, ensure you adopt the correct lifting posture to avoid injury. Ask for assistance if necessary.

BATTERIES

Your Powered wheelchair is equipped with GEL type batteries (acid free) which require only regular charging. To ensure trouble free operation of your powered wheelchair it is imperative to monitor the battery charge condition continuously and to recharge the batteries in good time. Intervals at which the batteries may need charging will vary and depend upon the conditions in which the powered wheelchair is being used, the weight of the user and ambient operating temperature in which the powered wheelchair is being operated.

New batteries need charging before your first journey and will not perform to their peak until the first six to ten charging cycles have been completed.

To ensure long battery life DO NOT allow your batteries to become totally discharged. If your powered wheelchair is not used for any length of time the batteries must receive a full charge once a month and remain fully charged during storage.

For replacement batteries contact your local INVACARE supplier/dealer in order to ensure that the new batteries are of the correct type and specification and are correctly installed and connected.



WHEN TO CHARGE:

Keep an eye on the battery charge indicator on the joystick box at full charge all six lights will be on (from right to left: green, amber, and red). As the battery charge drops during powered wheelchair operation successive lights will extinguish until eventually only the two red lights will be on. It means that you must charge the batteries without delay. We strongly advise you, however, not to wait until this critical point has been reached but to charge the batteries as early and as often as possible after you have used your powered wheelchair. If you ignore the warning (only two red lights on), and the battery charge drops further to a level where it is no longer sufficient to allow safe driving, the controller will automatically cut the power supply to the motors, so that the powered wheelchair comes to an abrupt halt, and you may find yourself stranded in an unpleasant situation.

Also, if you run down the batteries to such a low charge, you will have greatly reduced their potential service life.

Except in emergencies, never drive on discharged batteries, this will add strain to them and reduce their life. We recommend batteries should be charged every time the powered wheelchair is used, independent of the depth of discharge. Depending on this and their capacity, a full charge on completely discharged batteries can take up to approximately eight hours.

CHARGING PROCEDURES



IMPORTANT:

Before you attempt charging, ensure you read and understand the instruction manual supplied with the battery charger.



TO CHARGE BATTERIES:

- Check that the ventilation slots on the charger are clean and unobstructed.
- Plug the charger output lead into the socket on the joystick control box.
- DO NOT use while charging is in progress.
- Disconnect before use.

When charging is complete switch off and disconnect from the mains.

If required, the charger can be left connected to the powered wheelchair and to the mains. This will keep the batteries 100% charged and compensate for self-discharging over a long period. (You cannot overcharge your batteries).

If you experience charging difficulties or require further advice, do not hesitate to contact your local INVACARE supplier/dealer.

- Connect the charger power supply cable to the mains socket and switch the power on. The 'Mains ON' and the 'Charging' lights on the charger will come on.
- It is recommended the charger is left connected as described until the 'Full Charge' light illuminates to obtain optimum performance of the batteries.
- When the 'Charge Complete' light illuminates, the batteries are fully charged and ready for use.



NOTE:

An 'Over voltage' condition may occur temporarily while you are descending a steep gradient with fully charged batteries, when the motors virtually have the effect of a dynamo, adding to the batteries.



WARNING:

When you replace worn out batteries, fit the type recommended by the INVACARE supplier/dealer. If you use another type the battery gauge may be inaccurate.

8.6

Disposing & Recycling Of Used Batteries



You can help preserve our environment by returning your used rechargeable batteries to the collection and recycling location nearest to you. Batteries must always be correctly recycled. Under no circumstances should batteries be disposed of in domestic refuse.



NOTE:

For further information on the location of your nearest battery recycling facility please contact your local government authority.

9



Motor Locks, Wheels & Brakes

WARNING:

After any adjustments, repair or service and before use, make sure that all attaching hardware is tightened securely - otherwise injury or damage may result.



CAUTION:

As with any vehicle, the wheels and tyres should be checked periodically for cracks and wear, and should be replaced.

9.1 Disengaging / Engaging Motor Lock Levers



WARNING:

Do not engage or disengage motor locks until the power switch is in the OFF position.

I. Perform one of the following:

- Disengage (PUSH) - turn motor lock levers 'outwards' towards the wheel (as shown).
- Engage (DRIVE) - turn motor lock levers 'inwards' towards the centre of the chair.

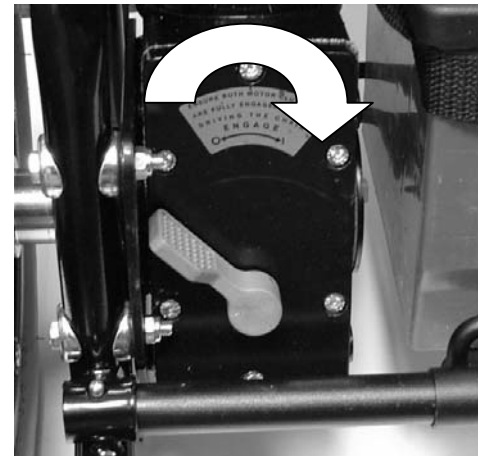

9.2

Drive Wheels



INFLATION:

Locate air valve and remove air cap.

Check the pressure rating marked on the side of the tyre and inflate as necessary.



CAUTION:

Do not over inflate tyres. As with any vehicle, the wheels and tyres should be checked periodically for wear.



REMOVAL:

- Release and remove the central screw (B) and the four surrounding screws (A) using a hex wrench.
- Pull the wheel away from the chair. It may be necessary to use some force.



CAUTION:

If the wheel rim is to be spilt to change a tyre, it is important that the bolts (C) holding the rim are not released if the tyre is pneumatic and inflated.

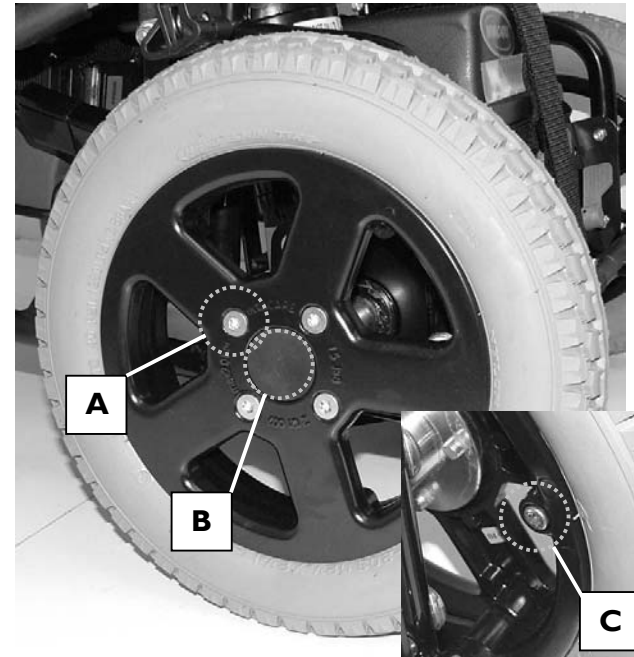

9.3 Manual Parking Brakes

To Activate Brake:

- Locate the brake grip handle.
- Pull the brake handle in an upwards direction until it engages.
- Repeat for opposite side of chair.

To De-Activate Brake:

- Locate the brake grip handle.
- Push the brake handle in a downwards until it disengages.
- Repeat for opposite side of chair.
- Brake handle.
- Brake disengage.



CAUTION:

Tyres must be correctly inflated for maximum brake efficiency.

10



Transportation

TRANSPORTATION OF WHEELCHAIRS IN VEHICLES RECOMMENDED RESTRAINT METHODS - FOR FOLDING FRAME CHAIRS:

For additional information, consult your INVACARE dealer.

For transportation purposes other than disassembly, the powered wheelchairs may be used in vehicles which have been modified specifically for the purpose. The powered wheelchair must be secured using these recommended restraint methods. **A standard crash test (ISO7176 - Part 19) was successfully carried out with the chair restrained facing the front of the vehicle. It is recommended that these guidelines are followed.**

The powered wheelchairs are not designed or manufactured to be replacements for purpose built vehicle seating. The occupant must be secured to the vehicle separately in addition to any wheelchair restraints. See Fig. No 2 on page 62. Manually operated drive wheel-locks must be used whilst the powered wheelchair is being transported. Figs. No 1A and 1B. show the route of the battery transportation strap and the position of the velcro fastening.

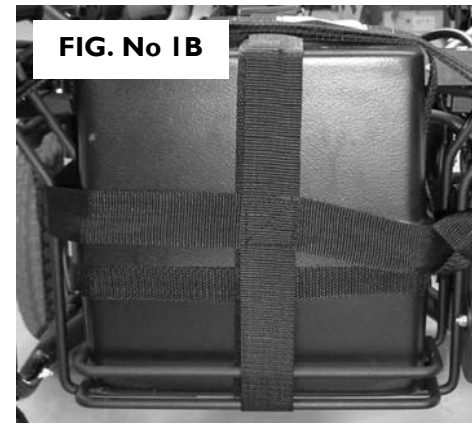
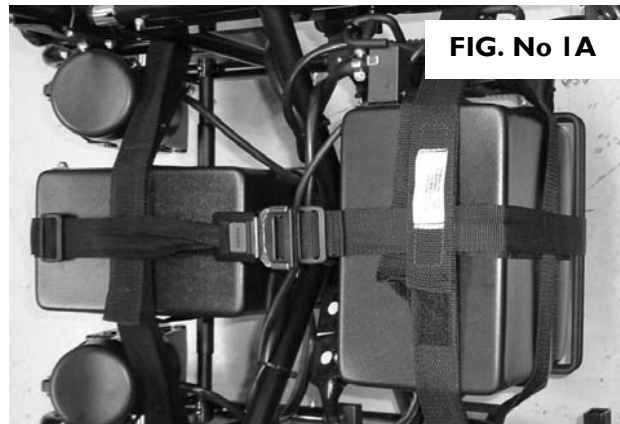



In addition to the velcro straps a two buckle battery transportation strap must be fitted for transportation in vehicles. (Please refer to section 8.2 'Battery Transportation Strap' for fitment instructions).

The illustration (Fig. No.2) shows a headrest arrangement (which can be fitted), the occupant's inertia reel restraint and wheelchair tie down details. The powered wheelchairs are not designed or manufactured to be replacements for purpose built vehicle seating. The occupant must be secured to the vehicle separately in addition to any wheelchair restraints. See Fig. No. 2. Manually operated drive wheel-locks must be used whilst the powered wheelchair is being transported.

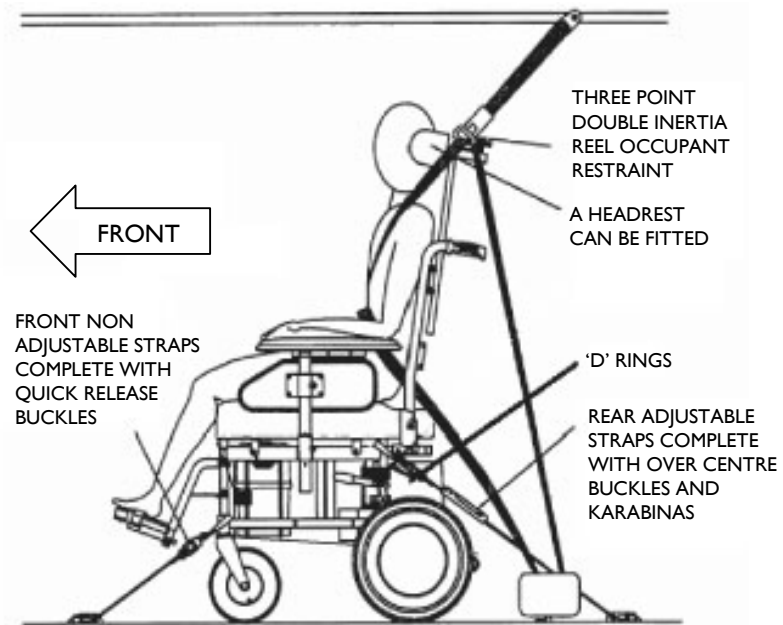

FIG No. 2



INVACARE recommend that the lap belt is used in addition to the specified tie-down/ three point occupant restraint system. However, the lap belt should be fitted under, and not be allowed to interfere with, the three point occupant restraint system (see note 8 on the next page).



CAUTION:

INVACARE always advises that a powered wheelchair secured in a vehicle will not provide the equivalent safety level and security as bespoke seating systems and recommends transfer to the vehicle seating, but also recognises that it is not always practical for the user to be transferred. In cases where transfer is not possible then the powered wheelchair should only be secured as follows:

Your safety during transportation, largely depends upon the diligence of the person securing the Tie-Downs and passenger restraints, it is your responsibility to ensure that your powered wheelchair has been secured safely.



1. The Harrier XHD™ has been crash tested and has met all pass requirements of ISO 7176 Part 19 and is suitable for transportation with an occupant in a vehicle.
2. Seek confirmation from the transporter that the vehicle is suitably designed, insured and equipped to transport a passenger seated in a powered wheelchair.
3. Any part of the powered wheelchair (accessories etc.) that can be easily detached should be removed and stored in the vehicle luggage hold during transportation.
4. The powered wheelchair should always be transported in a forward facing direction.
5. When attaching the tie-downs to the powered wheelchair, it is imperative they are fixed onto the tie-down points only of the powered wheelchair and not onto any attachments or accessories, as shown below (wheels, castors, footrests, armrests, anti-tipping levers, etc.).
6. The tie-downs should be secured, as close as possible, at an angle of 45° to ensure maximum effectiveness of the restraint in all directions.
7. Your Harrier XHD™ powered wheelchair can be fitted with a headrest to be used during transportation. For advice or to purchase these items contact INVACARE or your local dealer.
8. During transportation it is essential that you are secured by three point lap and diagonal occupant restraint system, which is anchored to the vehicle wall and floor rails. Powered wheelchair lap belts can be used in addition to the three point restraint system but must not be considered as an alternative to the occupant restraint system.



9. INVACARE recommend the 'Gemini System with 4-Point Heavy Duty Webbing Tie-Down System with Karabina' should be used to secure your chair within the vehicle, these restraints are available from Unwin Safety Systems (based in UK TA12 6EY, Tel: +44 (0) 1935 827740, <http://www.unwin-safety.com>).

This system comprises of a pair of non adjustable webbing straps with quick release buckles to secure the front (Fig. 3A) of the chair each side. A pair of straps complete with karabina locate over the rear (Fig. 3B) of the side frames on each side of the chair (labeled with the tie-down symbol). The adjustable straps are tensioned and the chair is locked down firmly using the over centre buckles.

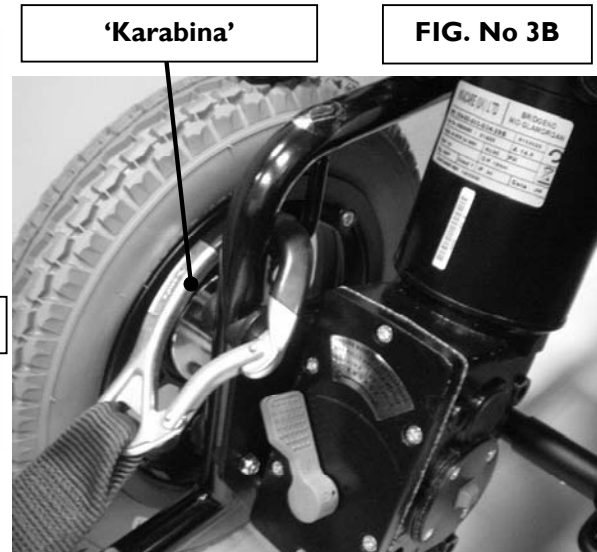
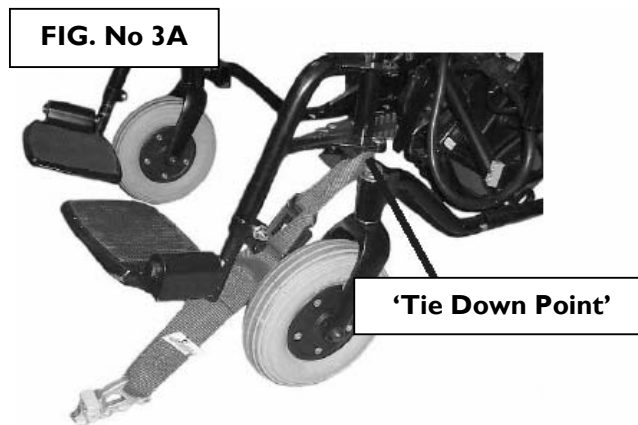

10.1 Disassembly & Folding



To enable your chair to be carried in the boot of most cars, please follow these instructions:

1. Follow the steps in 7.1 to remove the backrest.
2. Follow the steps in section 7.6 to remove the armrests. Ensure the controller is unplugged before carrying out this operation.
3. Follow the steps in section 7.10 to remove the seat board.
4. Follow the steps in section 8.1 to remove the batteries.
5. Follow the steps in section 7.11 to remove the kerb climber.
6. Follow the steps in section 7.12 or 7.13 to remove the leg rests or amputee supports.
7. To fold the chair, take a hold of the seat tube and lift. Your powered wheelchair is now ready to be loaded safely in a suitable vehicle. Reversing the procedure will make your chair ready for use at your destination.

If your power chair features a slung seat upholstery assembly, follow the above steps ignoring step 3.



NOTE:

If stored or transported when folded ensure the motor cables are not trapped, or have weight pressing on them, by inserting a pad or similar item between the motors.

II



Control Systems

NOTE:

Before you start using your powered wheelchair you must boost the battery charge by carrying out charging procedures as described in section 8.5 'Batteries & Charging' and always check the following:

1. Freewheel is engaged in drive position.
2. Adjustments have been made to suit your individual needs and fasteners securely tightened.
3. Tyres are in good condition and correctly inflated, or as specified on the tyre side walls.



CAUTION:

Do not use your powered wheelchair if the joystick boot shows any visible signs of damage. Please refer to your INVACARE dealer regarding repairs.

II.1

Types Of User Controller

Please refer to the control system user manual that has been supplied with your Harrier XHD™.

11.2 Joystick Mounting Hardware



WARNING:

After any adjustments, repair or service and before use, make sure that all attaching hardware is tightened securely - otherwise injury or damage may result.

FIXED JOYSTICK MOUNTING ARM INSTALLING / REMOVAL:

This type of mounting can move the joystick position either away from, or towards the armpad. This can be set according to comfort and arm length as follows. There is no height adjustment other than to vary the armrest height.

1. Unscrew the small handwheel (L) located on the underside of the armrest.
2. Install / remove the joystick mounting arm. Tighten small handwheel (L).

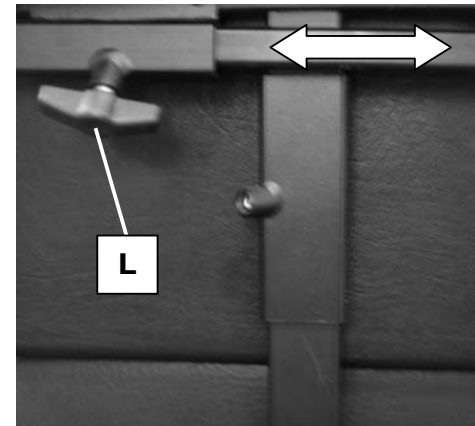

CAUTION:

Do not use your powered wheelchair if the joystick boot shows any visible signs of damage. Please refer to your INVACARE dealer regarding repairs.

ADJUSTMENT:

1. Unscrew the small handwheel (L) located on the underside of the armrest.
2. Slide the joystick to the desired position. Tighten small handwheel.

12

Transfers



Learning how to get in and out of a wheelchair safely and without injury is most important. Transferring to and from your powered wheelchair may require practice and a good sense of balance. It is recommended that whenever possible you have assistance when transferring to and from your powered wheelchair. It is recognised, however, that situations may occur when assistance is not available. It is desirable to learn and practice different techniques to accomplish a safe transfer.

Many experienced wheelchair users have developed and mastered their own method of transferring to and from the chair, resulting in great independence and self-care. Such ability depends largely on the strength of the individual, their capabilities and the type of chair. No single technique would be practical, or possible, for all wheelchair users. Safety is the primary consideration in all techniques.



Getting into the wheelchair:

- Position your wheelchair as close as possible to your seat. This might have to be done by an attendant.
- Switch your wheelchair off.
- Apply the hand brake of your wheelchair (if existing).
- Detach the side part of your wheelchair or swivel it up.
- Now slide into the wheelchair.

Getting out of the wheelchair:

- Drive your wheelchair as close as possible to your seat.
- Switch your wheelchair off.
- Apply the hand brake of your wheelchair (if existing).
- Detach the side part of your wheelchair or swivel it up.
- Now slide onto your new seat.

Attendant assistance is recommended and the following advice is relevant:

- The attendant lifting the occupant should take special precautions to avoid tipping or injuries from lifting, supporting, turning and lowering the patient.
- The attendant is responsible for stabilising the wheelchair and must take precautions to prevent the wheelchair moving or sliding during the transfer, i.e. apply brakes and ensure chair is not in free wheel.
- Be sure that the seat which is being transferred to is stable and will not create a possible hazard by moving or tipping when the occupant is raised or lowered. If in doubt, ask for assistance or use a device that will ensure safe transfer, i.e. patient lifter or transfer board.

13



Keeping Your Chair In Good Condition

Your powered wheelchair will benefit from periodic inspection, adjustment and replacement of worn parts. Regular maintenance will enhance

- Reliable performance
- Safety
- Extended battery life
- Confidence in operation
- Low operating costs

You can help keep your chair in good condition by following a simple guide to home maintenance.

CHROME/PAINTWORK:

This should be dried after contact with moisture. Clean once a month with a good quality auto-wax. Do not use abrasive cleaners such as chrome cleaner or scouring cleaners as these will scratch the finish. Do not store your chair in damp conditions.

UPHOLSTERY:

The upholstery on the powered wheelchair is vinyl or 'Plush' cloth material. Occasionally wipe with a damp cloth moistened with soapy water. **DO NOT** use abrasive or chemical cleaners as this may damage the fabric or vinyl coating. Vinyl upholstery will become hard and prone to cracking if the special coating, which is applied to maintain flexibility is removed by the abrasive, chemical cleaners or solvents.

Ultra-violet light can also reduce the life of the upholstery coating. This is a normal ageing process, necessary precautions should be taken to guard against periods of long-term exposure to sunlight. The result of these conditions cannot be covered by the specified warranty period.



BATTERIES

Keep your batteries well charged (see 'advice on batteries and battery charging' booklet). Keep batteries in a dry, frost-proof place. Be sure battery terminals remain tight and not corroded.

FOOTRESTS

Footrest heights are easily adjusted, clamp nuts must be securely tightened. Do not stand on the footplates.

CABLES AND CONNECTIONS

On a weekly basis, inspect all plug connections to be sure they are securely attached. A visual inspection is usually adequate. Ensure locking safety catch operates correctly and secures motor plugs. Inspect all wires for worn insulation. If any are found they should be replaced immediately. Make sure cables and wires are secured, and that they are routed away from any moving parts.

TYRES

Check the tread on your tyres regularly. Tyre pressure - inflate to recommended pressure as indicated in the technical information section. Do not exceed the maximum air pressure indicated on the tyre. Moulded tyres do not require pneumatic pressure, check periodically for wear.

14 **Fault Finding**

Remember that most power drive problems are battery related. Sometimes expensive components are unnecessarily replaced when in fact the problem was batteries. If an electrical problem exists, always check the batteries first, also check cable connections for good contact. The electronics involved in the controller and lift and recline modules are quite sophisticated:- electronic repairs should be carried out by trained personnel.

IF YOUR CHAIR WILL NOT START:

- Check that the control box is switched 'on', the display will be illuminated and remain stationary.
- Check that both motors are engaged.
- Check that the main controller cable is firmly pushed 'home'.
- Do not move the joystick until the display is illuminated.

IF THE WHEELCHAIR PULLS TO ONE SIDE:

- Check that the motors are fully engaged.
- Check that pneumatic tyres are inflated to correct pressure.
- Check that the castors move freely, and there is no free play at castor stem.
- Check joystick drive function is in line with the left and right response. One motor may be unplugged.

If your chair still has a problem after making these checks, please contact your INVACARE dealer.

15 **Waste Electrical & Electronic Equipment (WEEE) Directive 2002/96/EC**

This product has been supplied from an environmentally aware manufacturer that complies with the **Waste Electrical and Electronic Equipment (WEEE) Directive 2002/96/EC**.

This product may contain substances that could be harmful to the environment if disposed of in areas (landfills) that are not appropriate according to legislation.

The 'crossed out wheelie bin' symbol (as shown) is placed on this product to encourage you to recycle wherever possible.

Please be environmentally responsible and recycle this product through your recycling facility at its end of life.

DISPOSAL

- The equipment packaging is potentially recyclable.
- The metal parts are used for scrap metal recycling.
- The plastic parts are used for plastic recycling.
- Electrical components and printed circuit boards are disposed of as electronic scrap.
- Disposal must be carried out in accordance with the respective national legal provisions.
- If in doubt ask your local government authority for details of local waste management companies and recycling facilities.



16 ISO 7176 Part 15 Requirements for Information Disclosure, Documentation and Labelling

DOCUMENTATION AND LABELLING

DISCLOSURE OF TEST INFORMATION IN MANUFACTURERS SPECIFICATION SHEETS

MANUFACTURER: Invacare

ADDRESS: Invacare UK Ltd, Pencoed Technology Park, Pencoed, Bridgend, CF35 5 HZ

MODEL DESIGNATION: Harrier XHD Powerchair

MAXIMUM OCCUPANT MASS (WEIGHT): 160kg (25 stone)

ISO TEST METHOD	REQUIREMENT	MIN	MAX	ISO TEST METHOD	REQUIREMENT	MIN	MAX
ISO 7176 Pt 5	Overall Length with Legrest	1130 mm	1210 mm	ISO 7176 Pt 7	Seat Plane Angle	3°	3°
ISO 7176 Pt 5	Overall Width	660 mm (i)	760 mm (ii)	ISO 7176 Pt 7	Effective Seat Depth	490mm	525mm
ISO 7176 Pt 5	Folded Length	825mm	825mm	ISO 7176 Pt 7	Effective Seat Width	435mm (i)	575mm (ii)
ISO 7176 Pt 5	Folded Width	405mm	405mm	ISO 7176 Pt 7	Seat Surface Height at Front Edge	575mm	575mm
ISO 7176 Pt 5	Folded Height	745mm	745mm	ISO 7176 Pt 7	Backrest Angle	12°	24°
ISO 7176 Pt 5	Total Mass (Weight)	88kg	91kg	ISO 7176 Pt 7	Backrest Height	440mm	440mm
C.E.N	Mass (Weight) of the Heaviest Part		35kg chassis	ISO 7176 Pt 7	Footrest to Seat Distance	420mm	510mm

ISO 7176 Pt 1	Static Stability Downhill	24.5°	28°	ISO 7176 Pt 7	Leg to Seat Surface Angle	111°	111°
ISO 7176 Pt 1	Static Stability Uphill	17.5°	27.5°	ISO 7176 Pt 7	Armrest to Seat Distance	180mm	260mm
ISO 7176 Pt 1	Static Stability Sideways	20°	24.5°	ISO 7176 Pt 7	Front Location of Armrest Structure (Front Armrest to Backrest)	445mm	480mm
ISO 7176 Pt 4	Energy Consumption (Range)	18.5km	18.5km	ISO 7176 Pt 7	Handrim Diameter	n/a	n/a
ISO 7176 Pt 2	Dynamic Stability Uphill	10°	10°	ISO 7176 Pt 7	Horizontal Location of Axle	80mm	115mm
ISO 7176 Pt 10	Obstacle Climbing	65mm	100mm	ISO 7176 Pt 5	Minimum Turning Radius	970mm	
ISO 7176 Pt 6	Maximum Speed Forward	6.4km/h	6.4km/h	ISO 7176 Pt 5	Turn Around Width Between Limiting Walls	1320mm	
ISO 7176 Pt 3	Minimum Braking Distance From Maximum Speed	1008mm	1008mm		(i) 18in Wide Model (min) (ii) 22in Wide Model (max)		

Mass of the test dummy used in the test: Kilograms

The Wheelchair conforms to the following standards :

ISO 7176 Pt 8	Static, Impact and Fatigue Strength	<input type="text" value="PASS"/>
ISO 7176 Pt 9	Climatic Tests	<input type="text" value="PASS"/>
ISO 7176 Pt 14	Power and Controls	<input type="text" value="PASS"/>
ISO 7176 Pt 16	Resistance to Ignition	<input type="text" value="PASS"/>

Contacting INVACARE

For questions or support, please contact your authorized INVACARE dealer. They have the necessary experience, equipment, and knowledge concerning your wheelchair which enables them to offer you an all round satisfactory service.

Should you wish to contact us directly, we are at your service under the following addresses and telephone numbers:

European Headquarter:

Invacare International Sàrl, Route de Cité-Ouest 2, CH-1196 Gland
Tel : (41) (0)22 354 60 10, Fax : (41) (0)22 354 60 11
hqueurope@invacare.com
WWW.INVACARE.CO.UK

Sales Units:

Belgium & Luxemburg:

Invacare nv, Autobaan 22, B-8210 Loppem
Tel: (32) (0)50 83 10 10, Fax: (32) (0)50 83 10 11
belgium@invacare.com

Danmark:

Invacare AIS, Sdr. Ringvej 39, DK-2605 Brøndby
Tel: (45) (0)36 90 00 00, Fax: (45) (0)36 90 00 01
denmark@invacare.com

Deutschland & Eastern Europe:

Invacare Deutschland GmbH, Kleistraße 49, D-32457 Porta Westfalica
Tel: (49) (0)5731 75 40, Fax: (49) (0)5731 754 52 191
info@invacare.de

Aquatec GmbH, Alemannenstrasse 10, D-88316 Isny
Tel: (49) (0)7562 7 00 0, Fax: (49) (0)7562 7 00 66
infor@aquatec.de

Ulrich Alber GmbH, Vor dem Weissen Stein 21, D-72461 Albstadt-Tailfingen
Tel: (49) (0)7432 2006 0, Fax: (49) (0)7432 2006 299
info@ulrich-alber.de

España:

Invacare SA, c/Areny s/n, Polígon Industrial de Celrà, E-17460 Celra (Gironà)
Tel: (34) (0) 972 49 32 00, Fax: (34) (0)972 49 32 20
contactsp@invacare.com

France:

Invacare Poirier SAS, Route de St Roch, F-37230 Fondettes
Tel: (39) (0)2 47 62 64 66, Fax: (34) (0)2 47 42 12 24
contactfr@invacare.com

Italia:

INVACARE Mecc San s.r.l., Via dei Pini 62, I-36016 Thiene (VI)
Tel: (39) 0445 38 00 59, Fax: (39) 0445 38 00 34
italia@invacare.com

Nederland:

INVACARE BV, Celsiusstraat 46, NL-6716 BZ Ede
Tel: (31) (0)318 695 757, Fax: (31) (0)318 695 758
mobility@invacare.com
care@invacare.com

Norge:

INVACARE AS, Grensesvingen 9, Postboks 6230, Etterstad, N-0603 Oslo
Tel: (47) (0)22 57 95 00, Fax: (47) (0)22 57 95 01
norway@invacare.com
island@invacare.com

Österreich:

Mobitec Mobilitätshilfen GmbH, Herzog Odilostrasse 101, A-5310 Mondsee
Tel: (43) 6232 5535 0, Fax: (43) 6232 5535 4
office@mobitec-austria.com
austria@invacare.com

Switzerland:

Mobitec Rehab AG, Benkenstrasse 260, CH-4108 Witterswil
Tel: (41) (0)61 487 70 80, Fax: (41) (0)61 487 70 81
office@mobitec-rehab.ch
switzerland@invacare.com

Sverige and Suomi:

INVACARE AB, Fagerstagatan 9, S-163 91 Spånga
Tel: (46) (0)8 761 70 90, Fax: (46) (0)8 761 81 08
sweden@invacare.com
finland@invacare.com

Dolomite AB, Box 55, V. Götgatan 5, S-33421 Anderstorp
Tel: (46) (0)371 58 84 00, Fax: (46) (0)371 170 90
info@dolomite.se

Ireland:

Unit 5, Seatown Business Campus
Seatown Road
Swords
County Dublin
Ireland
Tel: +353 1 8107084, Fax: +353 1 8107085
ireland@invacare.com
www.invacare.ie

United Kingdom:

INVACARE Ltd, Pencoed Technology Park, Pencoed, Bridgend, CF35 5HZ
Tel: (44) (0)1656 776222, Fax: (44) (0)1656 776220
UK@invacare.com

WWW.INVACARE.COM



**Harrier XHD™ User Guide
Part No. 1433150 Issue 08
21-07-2010**