

E-MOTION[®]

duo drive

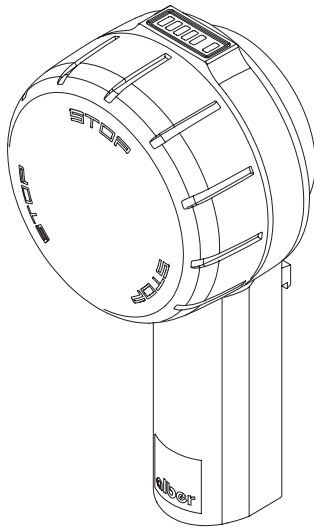

Gebrauchsanweisung e-motion DuoDrive DE

Instructions for Use e-motion DuoDrive EN

Instructions d'utilisation e-motion DuoDrive FR

Gebruiksaanwijzing e-motion DuoDrive NL

Bruksanvisning e-motion DuoDrive NO



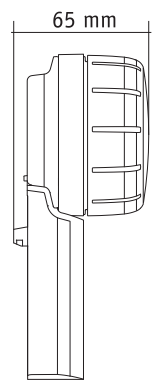
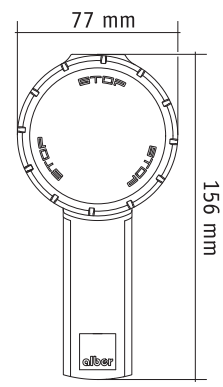
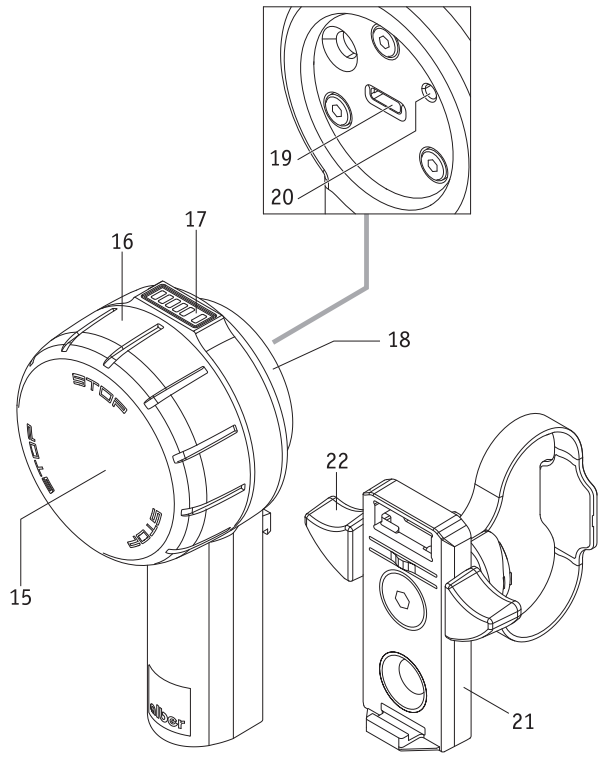

Contents

1.	Introduction	2	12.	Displays and error messages on the control unit	13
2.	Attaching and removing the control unit	3	12.1	Battery charge status of the e-motion wheels	13
3.	Setting the control unit	4	12.2	The charge status of the control unit battery	13
4.	Switching on the system	5	12.4.	Error and warning messages on the control unit	13
5.	Using the control unit (cruise mode)	6	13.	Automatic shutdown	14
6.	Emergency stop in hazardous situations	8	14.	Pairing	14
7.	Changing the assistance level	9	14.1	General information	14
8.	Using the optional ECS remote control or the Mobility app	10	14.2	Pairing the e-motion wheels with the control unit	15
9.	Switching off the control unit	10	15.	Technical data	16
10.	Charging the control unit batteries	11	16.	Minimum requirements for the charger	16
10.1	Information regarding chargers	11	17.	Safety instructions and hazard information when using the e-motion	17
10.2	Charging process	11	18.	Additional safety instructions for travelling in cruise mode	17
11.	Additional operating status displays on the e-motion wheel when travelling in cruise mode	12			



44.0001.4.99.03

Version: 2024-11-15

The latest applicable version of this operating manual is available for download on our website www.alber.de. If you require a large-print version, please download the instructions for use as a PDF file from our website. You can display this file larger on your screen.

1. Introduction

This operating manual provides information about the *e-motion M25 DuoDrive*, a control unit for use with the e-motion drive in cruise mode, hereinafter referred to as “e-motion”. Important tips, information and warnings are identified in this operating manual as follows:



Tips, information and special information.



Warning against possible hazards to your safety and health, and indication of potential risks of injury. Warning against possible technical problems or damage.

2

- Observe the instructions and warnings at all times to avoid injury to people and damage to the product.
- When used in this operating manual, terms such as “in front of”, “behind”, “left”, right” etc. refer to the respective position from the point of view of the wheelchair user.
- The symbols used on the labels and in some parts of this operating manual are explained in the e-motion M25 operating manual.



Alber GmbH excludes any liability for damage caused

- by use contrary to the intended purpose of the e-motion and its accessory parts;
- by use contrary to the intended purpose of the e-motion and its accessory parts by a person who has not been instructed;
- by use of the e-motion and its accessory parts contrary to the instructions and specifically the safety and hazard information in this operating manual;
- or by exceeding the technical limits laid down in this operating manual on the part of the user or third parties.



Before using the e-motion, carefully read all the safety and hazard information contained in the individual chapters of this operating manual and in the e-motion operating manual.

2. Attaching and removing the control unit

A retaining plate [21] for mounting the control unit to your wheelchair was attached by your specialist dealer. You can insert the control unit into the retaining plate and remove it at any time.

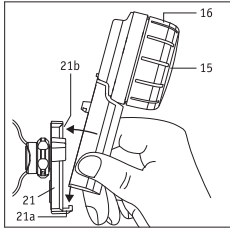

Attaching the control unit

- Apply the parking brakes of your wheelchair.
- Switch off both e-motion wheels (see the e-motion M25 operating manual).
- If the control unit is switched on, switch it off as well (see Chapter 9).
- Then insert the control unit into the mount [21a] on the retaining plate [21] at a slight angle. In doing so, hold the control unit by the handle at the bottom. Do not ever hold it by the speed dial [16] (see diagram).
- Tilt the control unit towards the retaining plate [21] until it audibly locks into place in the mount [21b].
- Check that the control unit is seated securely in the retaining plate [21].



When inserting the control unit into the retaining plate [21], do not ever hold it by the speed dial [16]. Hold it only by the handle (see diagram opposite). This prevents you from switching on the control unit unintentionally.

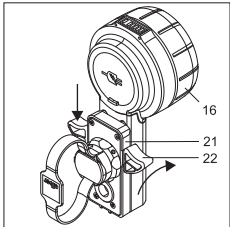

Removing the control unit

- Apply the parking brakes of your wheelchair.
- If you have not already done so, switch off both e-motion wheels (see the e-motion M25 operating manual).
- Switch off the control unit (see Chapter 9).
- Press down the locking mechanism [22] of the retaining plate [21] on one or both sides. Only hold the control unit by the handle, never by the speed selection dial [16].
- Remove the control unit from the retaining plate [21]. In doing so, hold the control unit by the handle. Do not ever hold it by the speed dial [16].
- Put the control unit down in a safe place.



When pressing down the locking mechanism [22] and removing the control unit from the retaining plate [21], never hold it by the speed selection dial [16], but only by the handle (see diagram).

This prevents the control unit from being switched on unintentionally and falling down.

Information for left-handed persons

- Unless you specify otherwise when ordering the e-motion, the retaining plate [21] is mounted on the right-hand side of the wheelchair as standard.
- The Mobility app allows the control unit to be switched to left-handed use at any time. Please consult the operating manual for the e-motion Mobility app for further information in this regard.

3. Setting the control unit

If desired or necessary, the position of the display [23] can be adjusted.

- Switch off both e-motion wheels completely (see the e-motion M25 operating manual).
- Open the cover [18] of the control unit.
- Loosen the three screws [25] on the back of the control unit by **not more than half a turn**. To this end, use an Allen key, size 2.5.
- Turn the ring [24] until the display [23] is in the desired position. Then carefully tighten the three screws [25] until the ring [24] can no longer be turned.
- Close the cover [18] of the control unit.

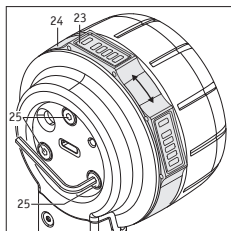

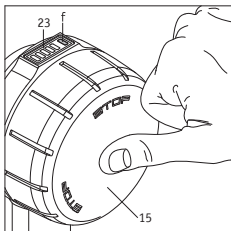

4. Switching on the system

When using the control unit, the e-motion is switched over to cruise mode. Both e-motion wheels and the control unit need to be switched on for use to be possible. Carry out the following steps to this end:

- Switch off all Bluetooth® devices in your immediate vicinity to prevent any interference when establishing a connection between the drive unit and the control unit.
- Switch on both e-motion wheels (see the e-motion M25 operating manual). If they are in standby mode (the middle white LED flashes briefly every 10 seconds), a connection to the control unit can be established.
- Switch on the control unit (this needs to be in the mount [21]) by pressing the button [15] on it for approx. 1 second.
- The LED [f] now indicates the capacity of the control unit battery in different colours (see Chapter 12.2). If the LED [f] is flashing blue, this indicates an attempt to establish a connection to the drive unit via Bluetooth®.
- If no Bluetooth® connection is established within 30 seconds, the LED [f] flashes red for 10 seconds. The control unit then switches off.
- If the Bluetooth® connection is established between the drive unit and the control unit, the LED [f] on the control unit continuously lights up green. See Chapter 12.2. for the meaning of the colour. The capacity of the drive unit battery is also displayed.

If no Bluetooth® connection is established after you have performed the steps listed above, this may be due to the following reasons:

Both e-motion wheel batteries are empty

Provided the control unit still gets a connection to the wheels, either an orange warning LED (wheel batteries low but not completely empty) or a red error LED (wheel batteries completely empty) appears depending on the charge status, and the control unit switches off after 10 seconds. If a connection is not established, the error LED also lights up red and the control unit switches off automatically after 10 seconds.

The control unit battery is empty

If the battery no longer has sufficient capacity, the LED [f] flashes briefly in the display [23] when the control unit is switched on. The system switches off completely thereafter. Charge the battery as described in Chapter 10.

Error in the system

In this regard, see the explanations in Chapter 12.3.

Fault due to Bluetooth® devices

Check that all Bluetooth® devices in your vicinity are switched off.

If this is the case and there is still no connection established between the drive unit and control unit despite repeated attempts, please contact your specialist dealer.

5. Using the control unit (cruise mode)

If both e-motion wheels and the control unit are connected via Bluetooth®, use of the e-motion can commence. Note the following in this regard:

- In cruise mode, the e-motion can (from the user's viewpoint) only move forwards; it cannot move backwards. For this reason, always mount the e-motion wheels the right way round! They have already been provided ex-works with stickers for left/right (direction of travel of the wheelchair). If the wheels are not fitted with the correct orientation, there is a risk that the wheelchair will move backwards. There is a risk of injury.
- The control unit does not have any braking functions. The push rims [5] of the e-motion wheels control the travel direction and braking of the wheelchair.
- Turning the speed dial [16] forwards sets the e-motion in motion. The further you move the speed dial in the direction of travel, the faster your wheelchair will move.
- The speed dial [16] can be turned infinitely. However, once the maximum speed is reached, no further increase in speed is possible.
- To reduce the speed, you need to turn the speed dial [16] against the direction of travel.
- To bring the wheelchair to a complete stop after switching off the drive, you need to brake it as usual using the push rims.
- You can also activate cruise mode when the wheelchair has started to move. The current speed of the wheelchair is used as the starting speed for cruise mode, from which you can set the cruising speed to be faster or slower by turning the speed dial [16] in or against the direction of travel.

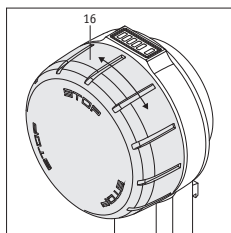



The prerequisite for the e-motion's continuous drive assistance is an active Bluetooth® connection between the control unit and the e-motion wheels. If this Bluetooth® connection is interrupted, the two e-motion wheels automatically switch to freewheeling mode. Power assistance using the push rims remains available. The wheelchair user can thus react to emergency situations at any time by using the push rims to operate the system like a manual wheelchair. If the Bluetooth® connection was interrupted, it must be re-established manually (see Chapter 4).

The entirety of the technologies used ensures an appropriate Quality of Service (QoS) for the Bluetooth® connection. The connection to the app runs via the same Bluetooth® module. The Bluetooth® connection is highly secure due to the latest up-to-date encryption and by taking SweynTooth vulnerabilities into account.

There can be various reasons for an interruption of the Bluetooth® connection.

The e-motion has successfully passed the EMC test according to ISO 7176-21, including the active Bluetooth® connection, and the Wireless Coexistence test according to ANSI C63.27:2017. Therefore, interruptions at home or in an office environment are highly unlikely. However, every potential source of strong interference cannot be anticipated.

Nonetheless, it is very unlikely that the Bluetooth® connection can be interrupted by other sources of interference such as anti-theft alarm systems.

Malicious hacker attacks cannot be completely ruled out in the medical device market. An attacker can try to crash the device, for example by triggering hard errors through the SweynTooth vulnerability, leading to a denial-of-service condition. If your e-motion's Bluetooth® connection has been interrupted by an attack, the system stops the driving assistance to get into the safe state of the system. In each case, the connection is interrupted; you can react at any time to avoid dangerous situations by manoeuvring the system like a manual wheelchair to thus remove yourself from the danger zone.



Please note that you can reach significantly higher speeds than cruise mode allows if cruise mode is deactivated and the e-motion is in freewheeling mode (e.g. when riding down-hill). In this situation, if you activate cruise mode using the control unit, the speed will be reduced very abruptly to the maximum cruising speed. There is an increased risk of falling forwards out of the wheelchair.



The individual gradations of the speed dial can be set individually via the e-motion Mobility app. In this regard, please read the relevant explanations in the e-motion Mobility app operating manual.



If the difference between the current travel speed and the maximum cruise mode speed is too high (more than approx. 4 km/h), the cruise mode cannot be activated using the control unit.

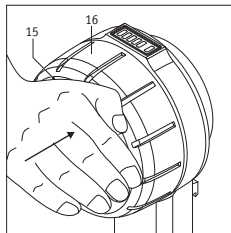

6. Emergency stop in hazardous situations

Every wheelchair user is trained to bring their wheelchair to an immediate stop in hazardous situations by braking it using its push rims.

To bring your wheelchair to a quick and safe stop in hazardous situations when using cruise mode, there are two options:

- Press the outer surface of the On/Off button [15]. This causes both e-motion wheels to switch to freewheeling mode with power assistance. However, the control unit is **not** switched off; it remains switched on!
- Once you have done this, use the push rims to brake the wheelchair and bring it to a complete stop as quickly as possible.
- Alternatively, in hazardous situations the wheelchair can be braked directly by using the push rims of the two e-motion wheels. To do this, simultaneously move the push rims against the direction of travel. This causes both e-motion wheels to switch to freewheeling mode with power assistance. The control unit is **not** switched off; it remains switched on! It may be necessary to move the push rims against the direction of travel for a longer period of time (approx. 1 second) in order to switch off cruise mode.



In the event of a collision with an obstacle, the e-motion wheels promptly switch off cruise mode.



By briefly pressing (less than 1 second) the On/Off button [15], neither the control unit nor the two e-motion wheels are switched off – as indicated by the illuminated LEDs. This means that the e-motion wheels are immediately set in motion again as soon as the speed dial [16] is turned (even unintentionally). In this respect, you should completely switch off the two e-motion wheels in the event of an emergency stop (see Chapter 9) until it is safe for you to continue.

7. Changing the assistance level

If the control unit is switched on and there is a Bluetooth® connection to the two e-motion wheels, it is possible to toggle between assistance level 1 and 2 for support for the manual, residual power-assisted travel mode. To do this, briefly press the On/Off button [15] twice (double-click).

When it is switched on, the e-motion is always in the assistance level that was activated before it was last switched off.



Depending on which assistance level is activated and set, the maximum possible cruising speed may vary, for example, a maximum of 4 km/h in assistance level 1, standard travel profile.

8. Using the optional ECS remote control or the Mobility app

Both the optional ECS remote control and the Mobility App can be used with the e-motion. However, for technical reasons, they cannot be used simultaneously with the control unit. Only one of these – either the control unit, the ECS remote control or the Mobility app – can communicate with the two e-motion wheels at any one time.

If you want to use the ECS remote control or the Mobility app, the control unit must be switched off beforehand (see Chapter 9). The two e-motion wheels are then in standby mode and can be connected and activated using the ECS remote control or the Mobility app with the ECS function enabled.

9. Switching off the control unit

The e-motion wheels go into standby mode if the control unit is switched off.

If the control unit is switched on, it can be used to switch off the two e-motion wheels or to set them to standby mode.

- By briefly pressing the On/Off button [15], both e-motion wheels switch to freewheeling mode with residual power assistance. Here, the control unit remains switched on.
- If the On/Off button [15] is pressed and held for longer than 2 seconds, both the control unit and the two e-motion wheels are put into standby mode. All LEDs on the control unit go out. On both e-motion wheels, the middle LED of the battery indicator briefly lights up every 10 seconds to signal standby mode.
- Depending on the time set in the wheels for automatic shutdown (see Chapter 13), the control unit shuts down as well. It can then be switched on again by pressing the On/Off button [15]. The two e-motion wheels are also automatically switched from standby mode to “ready for travel”.

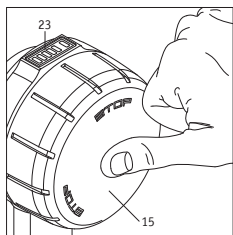

When travelling, particularly when travelling by plane, the control unit and both e-motion wheels must be shut down completely! For more information on air travel and flight mode, see the M25 operating manual and the app.

10. Charging the control unit batteries

10.1 Information regarding chargers

Alber does not supply a separate charger for the control unit. To charge the control unit battery, you can use a USB mains adapter that complies with the following technical parameters:

- Maximum +5 volts DC voltage
- Maximum 1.5 ampere current
- Connection for a USB type A charger cable

(the charger cable is included in the DuoDrive scope of delivery)

Alternatively, other USB mains adapters available from electrical retailers, which also comply with the USB 2.0 or USB 3.0 standard, may be used. However, the control unit may not necessarily charge if the charger used is not compatible.



**Chargers with a voltage of more than 5V may not be used under any circumstances!
Danger of destruction of the electronics due to overvoltage.**

10.2 Charging process

- Open the cover [18] and insert the USB charger cable into the charger socket [19]. This automatically interrupts the Bluetooth® connection to the wheels. Travel with the e-motion is now only possible in freewheeling mode (with power assistance).
- The charging process starts; the LED [f] of the control unit flashes green.
- The LED [f] lights up green continuously if the charging process is complete.
- Carry out the charging process in accordance with the charger operating manual.
- When the charging process is complete: remove the charger's USB cable from the control unit.
- Switch on the control unit again (see Chapter 4) to reactivate cruise mode.

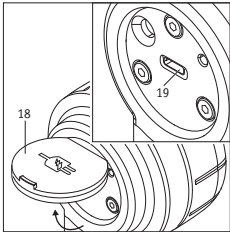

When charging, also follow the instructions in the operating manual of the charger used.



Before starting the charging process, switch off the system and secure the wheelchair using its parking brakes to prevent it inadvertently rolling away.



Maintenance-free, rechargeable lithium-ion batteries are integrated in the control unit. For safety reasons, these cannot be removed by the wheelchair user. If necessary, they must be removed by your authorised specialist dealer and be replaced by new batteries. Read and observe the safety instructions and precautions prior to starting up and prior to the charging process.



The control unit battery should always be fully charged so that you are able to make use of the maximum range during travel.

11. Additional operating status displays on the e-motion wheel when travelling in cruise mode

(For an overall layout, see the e-motion M25 operating manual)

Operating status	Signalling (to be recognised by)	Activate cruise mode by	Power consumption of the batteries
Cruise mode Control unit	Display for battery charge status via LED display [1] on the drive wheel and on the control unit.	Turning the speed dial [16]	Range of up to 15 km (on level ground) Actual power consumption depends on cruising speed, user weight and terrain.
Cruise mode	Display for the speed in cruise mode (subject to a surcharge) function of the e-motion Mobility app	Single push; cruising speed is logged in.	Range of up to 15 km (on level ground) Actual power consumption depends on cruising speed, user weight and terrain.

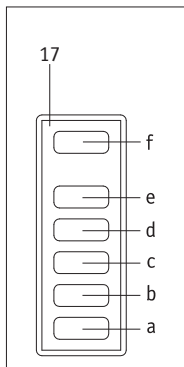

12. Displays and error messages on the control unit

12.1 Battery charge status of the e-motion wheels

If the control unit is connected to the drive wheels, the display [17] shows the charging status of the weaker battery as follows:

LED [a] flashes: Battery charge status < 10%

LED [a] lights up: Battery charge status > 10%

LEDs [a] and [b] light up: Battery charge status > 20%

LEDs [a], [b] and [c] light up: Battery charge status > 40%

LEDs [a], [b], [c] and [d] light up: Battery charge status > 60%

LEDs [a], [b], [c], [d] and [e] light up: Battery charge status > 80%

12.2 The charge status of the control unit battery

The charging status of the control unit battery is only indicated in the display [17] by LED [f].

LED [f] lights up green continuously: Battery capacity > 20-100%

LED [f] lights up yellow continuously: Battery capacity > 10-20%

LED [f] lights up red continuously: Battery capacity > 2-10%

LED [f] flashes red continuously: Battery capacity < 2%, battery almost empty

12.3 Error and warning messages on the control unit

Error and warning messages are shown on the LED display [1] on the affected wheel(see e-motion M25 operating manual.

- The LED [f] flashes red if a serious error occurs that prevents further travel with the e-motion wheels. Check the LED display [1] on the affected e-motion wheel for precise identification of the error. Alternatively, the wheel can be connected to the e-motion Mobility app for fault analysis.
- If a warning occurs that allows you to continue your journey, the LED [f] flashes yellow. Check the LED display [1] on the affected e-motion wheel to identify the exact warning.
- If an error has occurred on the control unit, the LED [f] lights up red. The control unit then switches off automatically after 10 seconds.

13. Automatic shutdown

To save power, the e-motion wheels will shut down automatically when not in use for a set period of time. The factory setting for this automatic shutdown time is 60 minutes. Your specialist dealer can adjust this for you.

The control unit is also deactivated at the time of the automatic shutdown. As of this moment, there is no longer an active Bluetooth® connection between the control unit and the e-motion wheels. These are then shifted to standby mode.

To put the system back into operation, the e-motion wheels can be switched on again via the control unit within 48 hours. If the wheels have been in standby mode for more than 48 hours, they must be switched on directly using their On/Off button [2].

14. Pairing

14.1 General information

If you have purchased the e-motion together with the control unit, it is already set up for the two wheels and can be put into operation immediately. If the control unit was replaced during a repair, it must be reprogrammed on the e-motion wheels.

For reasons of cybersecurity, i.e. to protect against possible hacker attacks, a smartphone with the e-motion Mobility app is required to pair the control unit. This app can be downloaded free of charge from the Apple App Store or from Google Play Store using the search term "e-motion M25".

14.2 Pairing the e-motion wheels with the control unit

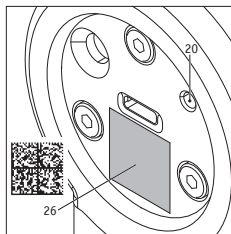

- Start the e-motion Mobility app on your smartphone and connect to the e-motion wheels if you have not already done so.
- Select the “Replace control unit” function in the Settings menu. The camera on your smartphone is started automatically.
- Open the cover [18] on the back of the control unit and scan the QR code sticker [26].
- A new message appears in the app, which you must acknowledge with OK.
- All 5 segments of the LED battery display of both e-motion wheels then flash white.

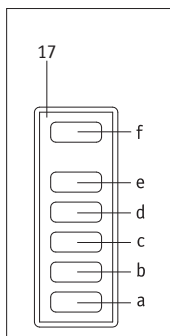

You can now start pairing the control unit.

- Now switch on the control unit using the On/Off button (see Chapter 4).
- Immediately afterwards, press the pairing button [20] on the back of the control unit for at least three seconds with a narrow but not pointed object (e.g. a ballpoint pen) until the LED [f] on the display [17] flashes blue and the LEDs [b] and [d] flash white.
- As soon as both e-motion wheels have been detected by the control unit (this process can take several seconds), the LED [f] lights up green. LEDs [a] through [e] show the battery status of the wheel with the lowest capacity.
- The pairing process has been successfully completed and the control unit can now be used together with the e-motion wheels.



The pairing process is only possible while the LED battery indicators of both e-motion wheels are flashing. If the specified time is exceeded, please repeat the process. If you cannot find a QR code on the e-motion wheels or the control unit or if they cannot be scanned, please contact your specialist dealer or the Alber Service Centre.



If you use the control unit on the left side of the wheelchair, a software setting by your specialist dealer will be necessary.

15. Control unit technical data

Cell type:	Lithium-ion 18650
Rated voltage:	3.6 VDC
Rated capacity:	2.6 Ah
Rated energy:	9.36 Wh
Charging temperature:	0° C to +45° C
Operating temperature:	-25° C to +50° C
Protection rating:	IPx4
Weight including battery:	0.25 kg

16. Minimum requirements for the charger (not included in the scope of delivery)

Output voltage:	Maximum +5 volts
Nominal output current:	Maximum 1.5 ampere current
Charger cable connection:	USB type A (the charger cable is included in the DuoDrive scope of delivery)

17. Safety instructions and hazard information when using the e-motion



Read and observe the safety instructions and hazard information from Chapter 3 onwards in the e-motion M25 operating manual.

18. Additional safety instructions for travelling in cruise mode (travel using the control unit or Mobility Plus app)

- Prior to use, check that the parking brakes of your wheelchair are working and are therefore able to prevent your wheelchair from rolling away inadvertently. If this is not the case, please contact your specialist dealer.
- Always mount the e-motion wheels the right way round! They have already been provided ex-works with stickers for left/right (direction of travel of the wheelchair). If the wheels are not fitted with the correct orientation, there is a risk that the wheelchair will move backwards. There is a risk of injury.
- If you have to replace a wheel or a control unit due to a defect, make sure when pairing again via the smartphone app that the wheels are mounted onto the wheelchair with the correct sides according to the stickers. If necessary, use additional stickers or a permanent marker to mark the new wheels.
- Always activate the parking brakes of your wheelchair before inserting the control unit into the bracket provided on the wheelchair.
- Do not switch on the control unit until you have attached it correctly.
- Before using cruise mode in public areas, you should first familiarise yourself with the travel characteristics in a safe and risk-free environment. Get a feel for the handling of the continuous drive, how to change direction during continuous drive, how to accelerate to an increased continuous speed, how to slow down, and what to do in case of an emergency stop. You should test and practise these fundamental driving situations before travelling on public roads.
- It is not possible to travel backwards in cruise mode. To do so, switch to power-assisted travel mode.
- The wheelchair is steered by its push rims when travelling in cruise mode.
- When cruise mode is activated, your hand must always be positioned near the push rims so that you can react quickly to change direction and stop the wheelchair safely.
- While travelling in cruise mode, your hands must always be close to the push rims so that you can brake the wheelchair promptly with your hands if cruise mode is switched off. If cruise mode is deactivated, the e-motion wheels are in freewheeling mode, but power assistance is still available.

- When travelling on slopes, it is possible for cruise mode to be deactivated unintentionally if the Bluetooth® connection to the smart-phone is interrupted or if both push rim sensors receive a travel signal as a result of a vibration. If cruise mode is deactivated, the e-motion wheels return to freewheeling mode and the speed of the wheelchair on slopes can increase. When travelling on slopes and inclines, keep your hands close to the push rims and be prepared to brake.
- Cruise control may only be activated by the person sitting in the wheelchair. Unauthorised persons not familiar with the cruise mode function are not permitted to activate or use the function.

Ihre Alber-Vertretung / Your Alber representative / Votre représentation Alber /
Vostra rappresentanza Alber / Su representación Alber / Din Alber representant /
Din Alber-agenturene / Uw distributeur Alber / Deres Alber-repræsentation

© Alber, Albstadt



Alber GmbH

Vor dem Weißen Stein 14

72461 Albstadt-Tailfingen

Telefon +49 (0)7432 2006-0

Telefax +49 (0)7432 2006-299

info@alber.de

www.alber.de