

Service Part Item Group: **Frame Components**

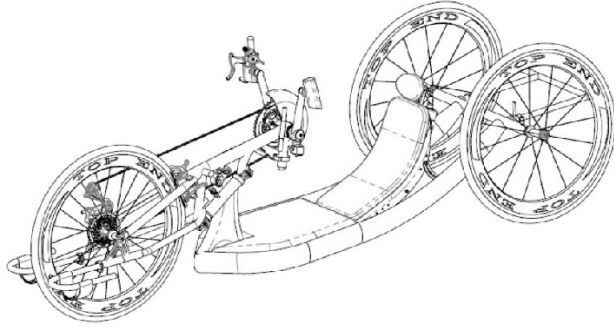

ABBREVIATION KEY	
ADJ	ADJUSTABLE
ASM	ASSEMBLY
BHCS	BUTTON HEAD CAP SCREW
BK	BIKE
CF	CARBON FIBER
CHRRINGS	CHAINRINGS
CLIN	CLINCHER
DB	DISC BRAKE
RH	RIGHT HAND
24T	24 TEETH
FHCS	FLAT HEAD CAP SCREW
FRC	FORCE
HP	HIGH PERFORMANCE
HPEDAL	HANDPEDAL
LH	LEFT HAND
MAG	MAGNETIC
MED	MEDIUM
REQD	REQUIRED
SHCS	SOCKET HEAD CAP SCREW
SHIFT	SHIFTER
SM	SMALL
SP	SPEED
SPECS	SPECIFICATIONS
SS	STAINLESS STEEL
STD	STANDARD
TUBU	TUBULAR
W/	WITH
WHL	WHEEL

Item Number:	Description:	Rev:	Rev Date:	Unit:
60104056	FRAME - COLOR: - SEAT WIDTH: - WHEEL BASE:	A	01/01/18	Pieces
60104158	<div style="border: 1px solid black; padding: 5px; display: inline-block;"> THESE REPRESENT THE ADDITIONAL INFORMATION THAT MAY BE NEEDED FOR THIS PARTS </div>			

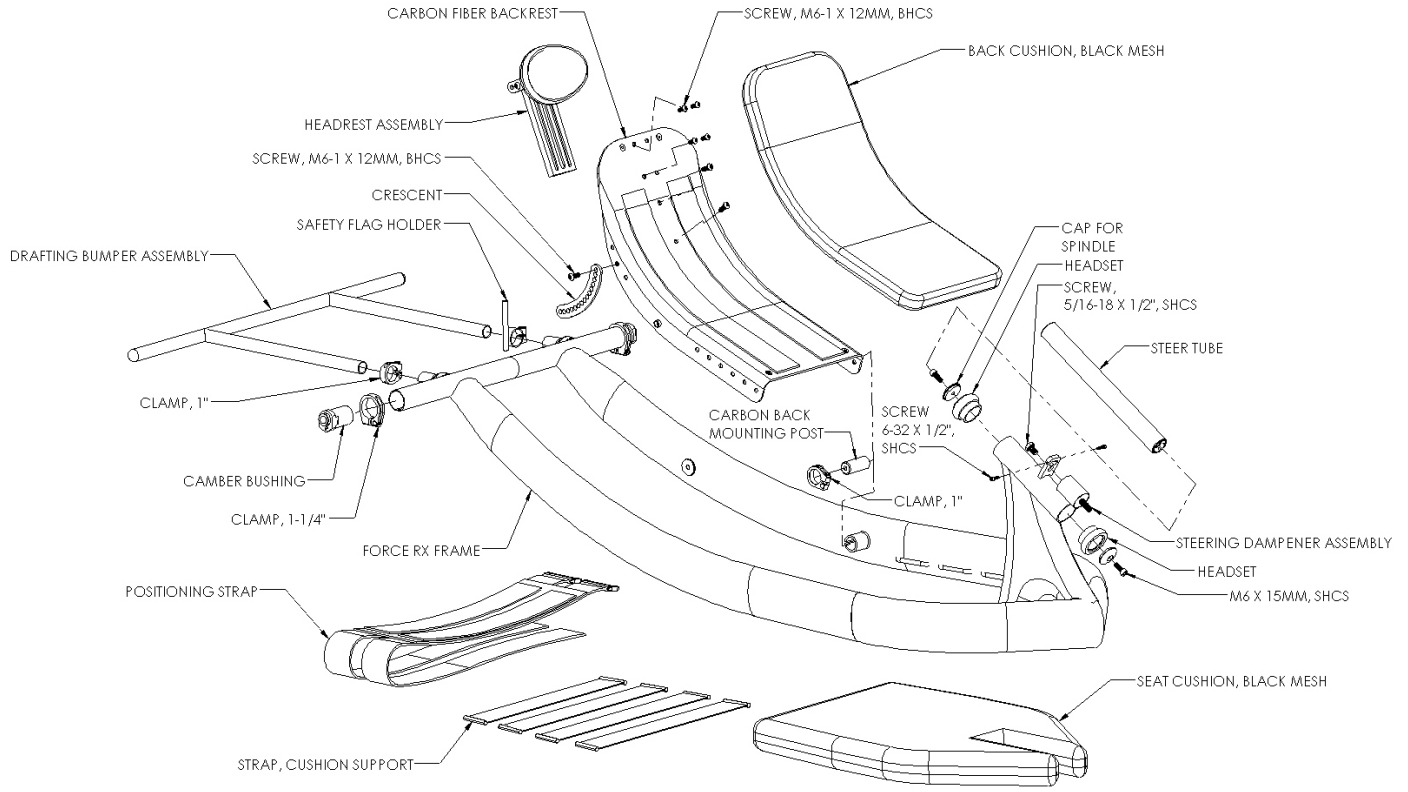

60103908

REVISION A 11.17.2017

Item Number:	Description:	Rev:	Rev Date:	Unit:	Price:	Image:
--------------	--------------	------	-----------	-------	--------	--------



Top End Wheelchair Service Part List: 60001574 FORCE RX

Service Part Item Group: Frame Components

1166344	BACK CUSHION, FORCE RX (IND SEAT TYPE) - FATSENING PREFERENCE: - SEAT WIDTH: - STYLE:	A	01/01/15	Pieces	\$130.00
60001794	BUMPER, FORCE SERIES, 20" AT 0 DEGREE	A	09/26/17	Pieces	\$55.00
60001797	BUMPER, FORCE SERIES, 26" AT 3 DEGREE	A	09/26/17	Pieces	\$65.00
60001798	BUMPER, FORCE SERIES, 26" AT 9 DEGREE	A	09/26/17	Pieces	\$70.00
60001799	BUMPER, FORCE SERIES, 700C 0 DEGREE	A	09/26/17	Pieces	\$73.00
60001801	BUMPER, FORCE SERIES, 700C 6 DEGREE	A	09/26/17	Pieces	\$79.00
60001795	BUMPER, FORCE SERIES, 20" AT 3 DEGREE	A	09/26/17	Pieces	\$68.00
60001796	BUMPER, FORCE SERIES, 26" AT 0 DEGREE	A	09/26/17	Pieces	\$70.00
60001800	BUMPER, FORCE SERIES, 700C 3 DEGREE	A	09/26/17	Pieces	\$79.00
1166704	CAMBER BUSH 00 INTEG THRD 1/2AX 1.25OD 058W	B	11/19/15	Pieces	\$35.00
1166706	CAMBER BUSH 03 INTEG THRD 1/2AX 1.25OD 058W	B	01/08/16	Pieces	\$35.00
1145951	CAP FOR SPINDLE	B	10/16/17	Pieces	\$8.75
1166579	CARBON BACK MOUNT POST, INDICATE 1-1/4" OR 2" L - POST SIZE:	A	01/01/15	Pieces	\$10.00
1166630	CARBON FIBER HANDCYCLE SEAT, STD 8.75	G	07/18/16	Pieces	\$450.00
1180951	CARBON FIBER HANDCYCLE SEAT, WIDE 10.75	F	07/18/16	Pieces	\$500.00
1139810	CLAMP, 1", SINGLE SCREW	A	06/03/16	Pieces	\$5.00
1166473	CLAMP, 1-1/4", SINGLE SCREW	A	11/13/17	Pieces	\$6.50





Top End Wheelchair Service Part List: 60001574 FORCE RX

Service Part Item Group: Frame Components





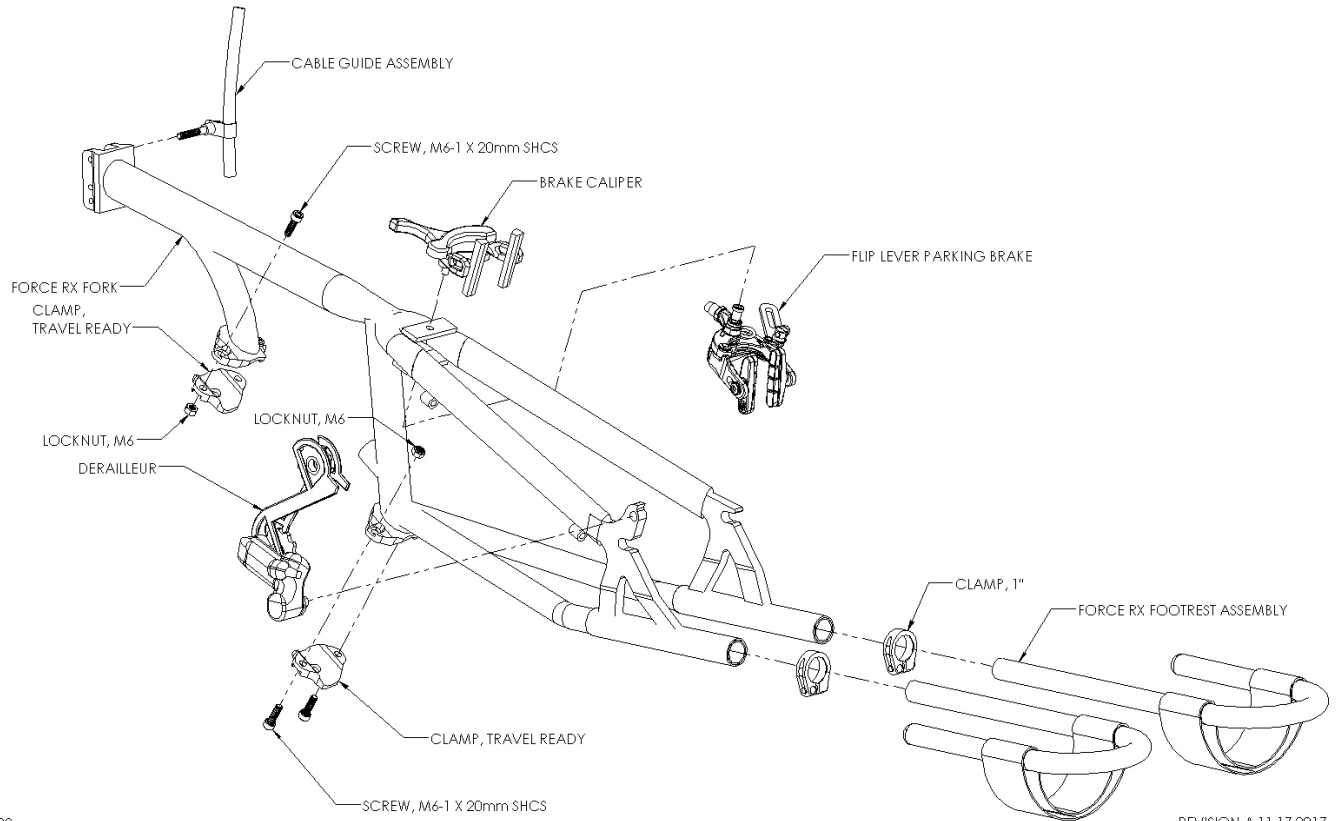

1180985	FRAME, FORCE RX HANDCYCLE FOR CARBON BACK	A	01/01/15	Pieces	\$1500.00	
1180938	HEADREST ASM TO FORCE RX CARBON FIBER BACK	A	01/01/15	Pieces	\$150.00	
1166667	HEADREST MOUNT BRACKET, FORCE RX	A	01/01/15	Pieces	\$40.00	
1166664	HEADREST WELDMOUNT W/FOAM (1/2" THICK HARD)	A	02/02/18	Pieces	\$68.00	
1166512	HEADSET SHAFT ASSEMBLY, FORCE RX (INCLUDES 2 STAR)	A	01/19/16	Pieces	\$12.00	
1166475	HEADSET, FORCE R & RX	B	07/28/17	Pieces	\$62.48	
1157271	LINK, CRESCENT MEDIUM BOLD BLACK	A	09/04/08	Pieces	\$39.00	
1153156	SEAT BELT/POSITIONING STRAP, FORCE SERIES - SEAT WIDTH:	A	01/01/15	Pieces	\$9.00	
1153054	SEAT CUSHION, NOTCHED (SPECIFY SEAT W), FORCE - SIZE:	A	01/01/15	Pieces	\$100.00	
1146018	STEERING DAMPENER ASM. (INCH) PRIOR TO 1/1/13	E	10/20/17	Pieces	\$10.00	
1166397	STEERING DAMPENER ASM. (METRIC)	B	11/19/15	Pieces	\$9.00	
1166348	STRAP, SEAT & BACK CUSHION SUPPORT	A	01/01/15	Pieces	\$15.00	

Service Part Item Group: Fork Components















60103909

REVISION A 11.17.2017

Item Number:	Description:	Rev:	Rev Date:	Unit:	Price:	Image:
60001646	CABLE GUIDE ASSEMBLY, FORCE	A	08/02/17	Pieces	\$14.00	
1196480	CHAIN ASM, 10 SP, 80" W/ MASTER LINK	A	12/29/16	Pieces	\$103.00	
1196479	CHAIN ASM, 11SP, 80" W/ MASTER LINK	A	03/28/17	Pieces	\$140.00	
1153164	CLAMP, HALF, PAINTED, FOR 1-1/8" - COLOR:	B	02/09/18	Pieces	\$15.00	
1181367	DERAILLEUR, WHEEL, 11SP SHIMANO DI2,XTR,ELEC	C	01/12/18	Pieces	\$800.00	
1181296	DERAILLEUR, WHEEL, 11SP SHIMANO DI2,ULTEG,ELEC	C	01/12/18	Pieces	\$375.00	
60104118	DERAILLEUR,WHEEL,10SP, SRAM,GX,CABLE	B	03/06/18	Pieces	\$85.00	
1153228	DIAGONAL ADJUSTMENT TUBE FOR CRANK ASSEMBLY - DI2 SHIFTING:	B	01/12/18	Pieces	\$35.00	

Top End Wheelchair Service Part List: 60001574 FORCE RX

Service Part Item Group: Fork Components

60001779	FOOTREST ASM, RH, 3-3/4" FORCE RX	A	09/19/17	Pieces	\$75.00	
60001780	FOOTREST ASM, LH, 3-3/4" FORCE RX	A	09/19/17	Pieces	\$75.00	
60001782	FOOTREST ASM, LH, 4-3/4" FORCE RX	A	09/19/17	Pieces	\$75.00	
60001781	FOOTREST ASM, RH, 4-3/4" FORCE RX	A	03/06/18	Pieces	\$75.00	
1153041	FORCE FORK, DIAGONAL & VERT ADJUSTMENT - DI2, FORK MOUNTED SHIFTING: - DI2, HANDPEDAL MOUNTED SHIFTING: - FORK COLOR: - FORK MOUNTED SECOND BRAKE: - LOWER FORK STYLE: - WHEEL SIZE: - XLT80: FORK MOUNTED SHIFTER:	A	01/01/15	Pieces	\$400.00	
1166316	FORCE FORK, FIXED LENGTH & HEIGHT (SPECS REQ'D) - BOTTOM BRACKET: - COLOR: - DI2, HANDPEDAL MOUNTED SHIFTING: - FORK MOUNTED, SECOND BRAKE: - LOWER FORK STYLE: - UPPER DERAILLEUR GUIDE: - WHEEL SIZE: - XLT80, FORK MOUNTED SHIFTER:	A	01/01/15	Pieces	\$900.00	
1153309	FORCE FORK, FIXED LENGTH & VERTICAL HEIGHT ADJ - DI2, FORK MOUNTED SHIFTING: - DI2, HANDPEDAL MOUNTED SHIFTING: - FORK COLOR: - LOWER FORK STYLE: - PARKING BRAKE STYLE: - WHEEL SIZE: - XLT80, FORK MOUNTED SHIFTER:	A	01/01/15	Pieces	\$575.00	
1166489	FORK CLAMP W/HARDWARE, FORCE RX & FORCE G	A	08/12/16	Pieces	\$25.00	
1166569	FORK MOUNTED SHIFTER TUBE ASSEMBLY (FORCE RX)	A	06/24/16	Pieces	\$12.00	
1166380	FORK MTD BRACKET, FORCE	G	02/09/18	Pieces	\$25.00	
1181301	INTERNAL BATTERY, DI2	C	07/24/17	Pieces	\$175.00	
1166230	KIT, FORK MOUNT DOUBLE	B	10/26/17	Pieces	\$25.00	

Top End Wheelchair Service Part List: 60001574 FORCE RX

Service Part Item Group: Fork Components

1166528	LEG GUARD ASSEMBLY WITH HARDWARE, FORCE	B	02/09/18	Pieces	\$80.00
1181823	POST, CLAMP-ON FOR FORK MOUNTED BRAKE, DIAG FORK	A	08/10/16	Pieces	\$25.00
1181831	ROAD BRAKE SHOES (INCL PADS AND HARDWARE)	A	08/12/16	Pieces	\$25.00
1068722	SAFETY MIRROR, MOUNTS INSIDE 7/8" TUBE	A	03/22/16	Pieces	\$36.50
1166330	SHIFTER,FORKMOUNT,10SP, APEX,ROAD-STYLE,WBRAKE	A1	01/25/18	Pieces	\$125.00
1166229	SINGLE-SIDED FORK MOUNT ASM (INCLUDES MOUNT)	A	01/01/15	Pieces	\$20.00
1181626	SPINDLE ASM, 6" W/ SHOULDER	A	03/22/16	Pieces	\$35.00



Service Part Item Group: Crank ASM Components

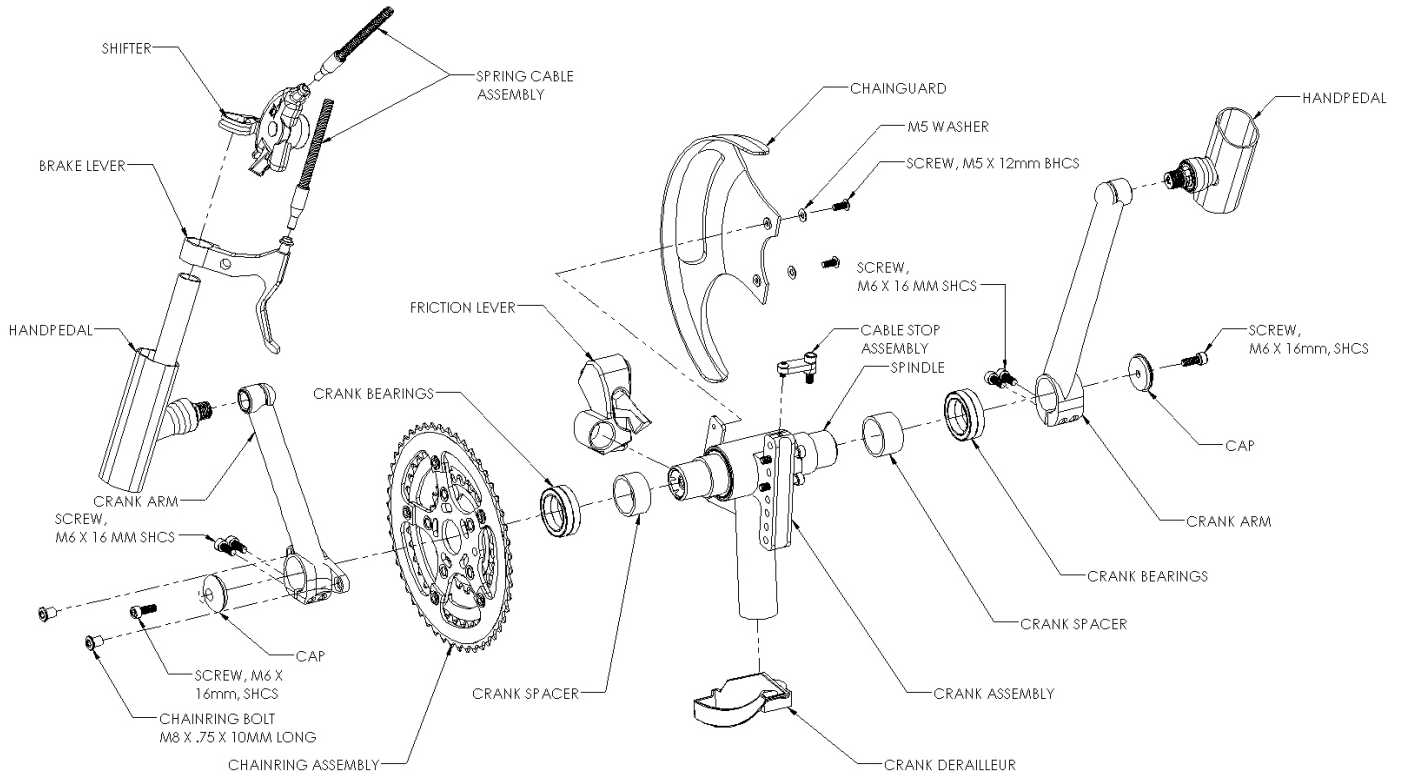

60103956

REVISION A 01.02.2018

Item Number:	Description:	Rev:	Rev Date:	Unit:	Price:	Image:
1127921	BEARING,CRANK,30 X42 X7MM	A	03/23/16	Pieces	\$8.00	
1181053	CABLE SPRING ASM, SHIFTER BRAKE	D	08/11/17	Pieces	\$12.00	
1181065	CABLE STOP ASSEMBLY, FORCE	B	03/11/16	Pieces	\$6.00	
1166338	CHAINRING ASM, 48-39-24T BLACK	B	07/01/16	Pieces	\$140.00	
1166339	CHAINRING ASM, 53-39-28T BLACK	A	01/01/15	Pieces	\$150.00	
1109802	CHAINRING BOLT, 9MM M8 X. 75 WITH NUT	A	05/23/17	Pieces	\$2.25	
1156773	CHAINRING GUARD - SOLID	A	05/09/16	Pieces	\$24.85	
1181561	CHAINRING GUARD ASSEMBLY CARBON FIBER	B	08/16/17	Pieces	\$120.00	















Top End Wheelchair Service Part List: 60001574 FORCE RX

Service Part Item Group: Crank ASM Components

1181058	CHAINRING, 22T, 58MM BCD, 5 BOLT, BLACK	A	01/01/15	Pieces	\$30.00	
1166471	CHAINRING, 24T, 74MM BCD, 5 BOLT, BLACK	A	01/08/16	Pieces	\$17.00	
1109799	CHAINRING, 28T, 74MM BCD, 5 BOLT	A	06/07/16	Pieces	\$20.00	
1166555	CHAINRING, 48T, 110MM BCD, 5 BOLT, BLACK	A	01/01/15	Pieces	\$50.00	
1109801	CHAINRING, 48T, 130MM BCD 5 BOLT, BLACK, RAMPED	A	12/17/15	Pieces	\$47.00	
1181060	CHAINRING, 53T, 110MM BCD, 5 BOLT, RAMPED, BLACK	A	01/01/15	Pieces	\$60.00	
1166282	CRANK ARM ASM, S-CRANK, 1.3/4" CLAMPS - CRANK LENGTH: - CRANK WIDTH: - MODEL/HANDPEDAL ANGLE:	C	02/15/17	Pair	\$180.00	
1166217	CRANK ARM ASM, V-CRANK, TAPERED, 1-1/2" CLAMPS - CRANK LENGTH: - CRANK WIDTH: - MODEL / HAND PEDAL ANGLE:	E	10/16/17	Pair	\$200.00	
60001433	CRANK ASM, FRC, CABLE, 7" SPINDLE (THREADLESS)	A	07/10/17	Pieces	\$150.00	
60001430	CRANK ASSY., FRC, CABLE, 6" SPINDLE (THREADED)	A	05/24/17	Pieces	\$150.00	
60001429	CRANK ASSY., FRC, CABLE, 6" SPINDLE (THREADLESS)	A	07/10/17	Pieces	\$150.00	
60001434	CRANK ASSY., FRC, CABLE, 7" SPINDLE (THREADED)	A	07/10/17	Pieces	\$150.00	
60001436	CRANK ASSY., FRC, MANUAL, 7" SPINDLE (THREADED)	A	07/10/17	Pieces	\$150.00	
60001435	CRANK ASSY., FRC, MANUAL, 7" SPINDLE (THREADLESS)	A	07/10/17	Pieces	\$150.00	
1166516	CRANK WIDTH EXTENSIONS	A	09/22/17	Pair	\$20.00	
1166488	DERAILLEUR, CRANK, 9-11SP 2-3CHRRINGS SHIMANO, CABLE	D	01/12/18	Pieces	\$65.00	

Top End Wheelchair Service Part List: 60001574 FORCE RX

Service Part Item Group: Crank ASM Components

1139745	DERAILLEUR,CRANK,9-11SP 2-3CHRRINGS SHIMANO,MANUAL	C	09/26/16	Pieces	\$125.00	
1166214	HANDPEDAL W/POWER PLATE, GRIP SHIFT, SPECS REQD - BIKE MODEL: - DEGREE: - ORIENTATION: - SIZE:	A	01/01/15	Pieces	\$150.00	
1166212	HANDPEDAL W/POWER PLATE, NON-SHIFTING, SPECS REQD - BIKE MODEL: - DEGREE: - ORIENTATION: - SIZE:	A	01/01/15	Pieces	\$130.00	
1166216	HANDPEDAL W/POWER PLATE, TRIGGER SHIFT, SPECS REQD - BIKE MODEL: - DEGREE: - ORIENTATION: - SIZE:	A	07/11/17	Pieces	\$145.00	
1166213	HANDPEDAL, GRIP SHIFT ,SPECS REQD - BIKE MODEL: - DEGREE: - ORIENTATION: - SIZE:	A	07/11/17	Pieces	\$125.00	
1166211	HANDPEDAL, NON-SHIFTING ,SPECS REQD - BIKE MODEL: - DEGREE: - ORIENTATION: - SIZE:	A	07/11/17	Pieces	\$105.00	
1166215	HANDPEDAL, TRIGGER SHIFT ,SPECS REQD - BIKE MODEL: - ORIENTATION: - SIZE:	A	07/11/17	Pieces	\$120.00	
1180902	MASTER LINK, 10-SPD	A	10/22/15	Pieces	\$4.00	
1166481	SHIFTER,FRICTION,SHIMANO, CRANKMOUNT,SHIFT OR BRAKE	B1	01/25/18	Pieces	\$20.00	
60104117	SHIFTER,TRIGGER,10SP, SRAM,GX,HPEDAL MOUNT	A	03/06/18	Pieces	\$31.33	
1166548	SHIFTER,TRIGGER,10SP,SRAM ,X9,HPEDAL MOUNT	B	01/25/18	Pieces	\$56.62	
1166503	SHIFTER,TRIGGER,10SP,SRAM ,XX,HPEDAL MOUNT	B	01/25/18	Pieces	\$192.00	
60104119	SHIFTER,TWIST,10SP,SRAM, GS,HPEDAL MOUNT	A	03/06/18	Pieces	\$75.00	
1166484	SPACER, CRANK, 3/4" LONG FOR 30MM SPINDLE	B	04/05/16	Pieces	\$10.00	



Top End Wheelchair Service Part List: 60001574 FORCE RX

Service Part Item Group: Crank ASM Components

1134540	SPACER, CRANK, 5/8" LONG FOR 30MM SPINDLE	B	06/25/15	Pieces	\$10.00	
1166631	SPIDER, 110MM WITH 5 TAPS	B	06/17/16	Pieces	\$50.00	
1153311	SPINDLE ASM, 7" W/SHOULDER	A	03/22/16	Pieces	\$35.00	
1166280	SRM ADAPTER, TRIPLE (FORCE RX)	D	06/17/16	Pieces	\$140.00	
1181734	SRM DOUBLE COMPACT POWER METER, 110MM BCD	B	10/20/17	Pieces	\$3175.00	
1181736	SRM DOUBLE POWER METER, 130MM BCD	A	07/21/16	Pieces	\$3250.00	
1180966	SRM SPINDLE ADAPTER ASSEMBLY	E	09/19/16	Pieces	\$75.00	
1181735	SRM TRIPLE POWER METER, 130MM & 74MM BCD	B	10/20/17	Pieces	\$3250.00	
1181631	TAPERED V-CRANK ARM SET 1" CLAMPS	D	07/27/16	Pair	\$200.00	
1166568	TOP END COMPACT CHAINRING ASSEMBLY, 48-34-24T	B	01/01/15	Pieces	\$160.00	



Top End Wheelchair Service Part List: 60001574 FORCE RX

Service Part Item Group: Shifting Components

Item Number:	Description:	Rev:	Rev Date:	Unit:	Price:	Image:
1181302	BATTERY CHARGER, INTERNAL BATTERY DI2	A	11/19/15	Pieces	\$125.00	
1181293	DI2 WIRE, 1200MM BLACK	B	04/26/16	Pieces	\$35.00	
1181292	DI2 WIRE, 400MM BLACK	A	11/19/15	Pieces	\$30.00	
1181368	DI2 WIRE, 800MM BLACK	A	12/31/15	Pieces	\$30.00	
1181305	JUNCTION BOX B 4 PORT INLINE, DI2	A	11/19/15	Pieces	\$35.00	
1181304	JUNCTION-A 5 PORT AND CHARGING PORT, DI2	A	11/19/15	Pieces	\$100.00	
1181308	SHIFT-BRAKE LEVER, DI2 RH FORK MOUNT	A	03/19/15	Pieces	\$275.00	
1166575	SHIFTER,DOUBLETAP,10SP, HPED,QUADGRIP OR ELBOW	A1	01/25/18	Pieces	\$110.00	
1181306	SHIFTER,ELEC,11SP,DI2,RT, SHIM,HPEDAL MOUNT,W/BRAKE	B	01/26/18	Pieces	\$225.00	

Top End Wheelchair Service Part List: 60001574 FORCE RX





Service Part Item Group: Braking Components

Item Number:	Description:	Rev:	Rev Date:	Unit:	Price:	Image:
1181527	BRAKE CALIPER, TORQ-LITE ROAD II	B	01/19/18	Pieces	\$175.00	
1156720	BRAKE CALIPER, DISC BRAKE , AVID	A	06/24/16	Pieces	\$75.00	
1180839	BRAKE CALIPER, REAR R540 TEKTRO	B	06/24/16	Pieces	\$80.00	
1166474	BRAKE LEVER, AVID	B	09/20/17	Pieces	\$60.00	
1166340	BRAKE LEVER, PRO FORCE ULTRALT (FORCE RX)	B	09/22/17	Pieces	\$120.00	
1166557	BRAKE LEVER, SRAM TT	B	06/17/16	Pieces	\$55.00	
1180897	BRAKE PADS (PAIR) FOR CARBON WHEELS, CORIMA	A	06/24/16	Pair	\$28.00	
1156769	BRAKE PADS DISC BRAKE ROTOR	A	06/23/16	Pair	\$30.00	
1166463	BRAKE PADS FOR STD METAL RIMS	A	06/24/16	Pair	\$15.00	
1156768	BRAKE ROTOR, 180MM, DISC BRAKE, FOR STD FRONT WHL	A	06/23/16	Pieces	\$75.00	
1139823	CARBON WHEEL REPLACEMENT BRAKE PADS	A	06/20/16	Pair	\$28.00	



Top End Wheelchair Service Part List: 60001574 FORCE RX

Service Part Item Group: Cable & Housing Components

Item Number:	Description:	Rev:	Rev Date:	Unit:	Price:	Image:
1146016	CABLE AND HOUSING FOR SHIFTER - MODEL:	A	01/01/15	Pieces	\$15.00	
1146015	CABLE AND HOUSING FOR HAND BRAKE - MODEL & TYPE:	A	01/01/15	Pieces	\$10.00	
1146014	CABLE AND HOUSING: SPEC'S REQUIRED - MODEL & LENGTH:	A	01/01/15	Pieces	\$10.00	
1060284	CABLE TIP (SPICY)	A	06/22/17	Pieces	\$0.25	
1166609	FERRULE HOUSING, 5MM JAG	A	04/20/15	Pieces	\$0.45	

Top End Wheelchair Service Part List: 60001574 FORCE RX

Service Part Item Group: Wheels

Item Number:	Description:	Rev:	Rev Date:	Unit:	Price:
1166594	ADAPTER, BRAKE ROTOR FOR DISC BRAKE, CORIMA WHEELS	A	06/24/16	Pieces	\$27.97
1166462	AXLE, THREADED 3-1/4" LONG	A	03/25/16	Pieces	\$34.00
1166246	AXLE, THREADED 3-3/4" LONG	C	03/30/16	Pieces	\$27.50
1054030	BEARING, (1/2" ID X 1-1/8" OD X 5/16")	A	01/01/15	Pieces	\$7.00
1181369	CASSETTE, 11SP 11-36 PG-1130	A	12/31/15	Pieces	\$175.00
1181312	CASSETTE, ULTEGRA 11-32, 11-SPEED	A	11/19/15	Pieces	\$175.00
1166505	SRAM OG CASSETTE CLUSTER: 11-28, 10 SPEED (FORCE X	A	01/01/15	Pieces	\$350.00
1166547	SRAM PG1050 CASSETTE 11-36T 10SPD	A	01/01/15	Pieces	\$90.00
1181177	WHEEL, 20", CORIMA-AERO, REAR, CF, TUBU, W/AXLE	A1	01/16/18	Pieces	\$1000.00
1181178	WHEEL, 20", HP, REAR, CLIN	C	01/16/18	Pieces	\$175.00
1156724	WHEEL, 26"(650), CORIMAAERO, FRONT, 9-11SP, CF, TUBU	A1	01/16/18	Pieces	\$1150.00
1156771	WHEEL, 26"(650), CORIMAAERO, FRONT, 9-11SP, CF, TUBU, DB	A1	01/16/18	Pieces	\$1275.00
1156725	WHEEL, 26"(650), CORIMAAERO, REAR, CF, TUBU, W/AXLE	A1	01/16/18	Pieces	\$1050.00
1181795	WHEEL, 26"(650), CORIMADISC, LH, REAR, CF, TUBU, W/AXLE	B1	01/16/18	Pieces	\$775.00
1181794	WHEEL, 26"(650), CORIMADISC, RH, REAR, CF, TUBU, W/AXLE	B1	01/16/18	Pieces	\$775.00
1156776	WHEEL, 26"(650), HP, FRONT, 9-11SP, CLIN	C	01/18/18	Pieces	\$200.00

Image:



Top End Wheelchair Service Part List: 60001574 FORCE RX

Service Part Item Group: Wheels

1156778	WHEEL,26"(650),HP,REAR, CLIN	A1	01/16/18	Pieces	\$145.00
1166385	WHEEL,26"(650),SPINERGY, FRONT,9-11SP,CF,CLIN	D1	01/16/18	Pieces	\$1175.00
1166386	WHEEL,26"(650),SPINERGY, REAR,CF,CLIN,W/AXLE	D1	01/16/18	Pieces	\$900.00
1166260	WHEEL,26"(650),TOP END, FRONT,9-11SP,CF,TUBU	A1	01/16/18	Pieces	\$900.00
1166261	WHEEL,26"(650),TOP END, REAR,CF,TUBU	A1	01/16/18	Pieces	\$800.00
1180840	WHEEL,700C,CORIMA-AERO, FRONT,9-11SP,CF,TUBU	A1	01/16/18	Pieces	\$1150.00
1180898	WHEEL,700C,CORIMA-AERO, FRONT,9-11SP,CF,TUBU,DB	A1	01/16/18	Pieces	\$1275.00
1180841	WHEEL,700C,CORIMA-AERO, REAR,CF,TUBU,W/AXLE	A1	01/16/18	Pieces	\$1050.00
1181062	WHEEL,700C,HP,FRONT, 9-11SP,CLIN	A	01/16/18	Pieces	\$200.00
1181063	WHEEL,700C,HP,REAR, CLIN	B	07/31/17	Pieces	\$225.00





Top End Wheelchair Service Part List: 60001574 FORCE RX

Service Part Item Group: Tires, Tubes, and Rim Strips

Item Number:	Description:	Rev:	Rev Date:	Unit:	Price:	Image:
1181181	20" INNER TUBE FOR REAR HANDCYCLE WHEEL	E	07/10/17	Pieces	\$7.70	
60104098	PUMP ADAPTER, EXTENSION FOR PRESTA VALVE	A	02/21/18	Pieces	\$12.00	
1181758	RIM STRIP BK-WHEEL , 20" (406) X 19MM	B	07/11/17	Pieces	\$6.00	
1139812	RIM STRIP WC & BK-WHEEL , 26" (571, 650C) X 16MM	B	03/01/18	Pieces	\$6.00	
1139811	RIM STRIP WC&BK-WHEEL , 700C (700C) X 16MM	B	07/11/17	Pieces	\$6.00	
1181180	TIRE, 20" CONTINENTAL CLINCHER	A	01/01/15	Pieces	\$50.00	
1181179	TIRE, 20" TUBULAR VITTORIA	A	01/01/15	Pieces	\$80.00	
1060149	TIRE, 26" (23-571) PANARACER STRADIUS ELITE	A1	03/03/17	Pieces	\$27.70	
1156680	TIRE, 26" (23-571) GRAND PRIX CONTINENTAL CLINCHER	B	08/30/17	Pieces	\$60.00	
1166472	TIRE, 26" 650X22 SPRINTER CONTINENTAL, TUBULAR	A	03/11/16	Pieces	\$65.00	
1166580	TIRE, 700C (23-622) GRAND PRIX CONTINENTAL CLINCHER	A	03/11/16	Pieces	\$60.00	
1139820	TUBE 26" (571) HP W/LONG STEM	A	01/01/15	Pieces	\$7.70	
1060160	TUBE 26X1 (650) W/ PRESTA VALE STD STEM	B	06/23/17	Pieces	\$7.70	
1060161	TUBE, 700C X 19/20"	A	07/11/17	Pieces	\$10.00	



Top End Wheelchair Service Part List: 60001574 FORCE RX

Service Part Item Group: Accessories

Item Number:	Description:	Rev:	Rev Date:	Unit:	Price:	Image:
1056875	CORDLESS COMPUTER	A	01/01/15	Pieces	\$95.00	
1109717	ALIGNMENT GAGE	B	10/16/17	Pieces	\$150.00	
1060798	BACK PACK HYDRATION SYSTEM - MODEL:	B	01/01/15	Pieces	\$121.40	
60001619	BIKE RACK, 1-1/4" HITCH RECEIVER	A	08/11/17	Pieces	\$527.60	
60001638	BIKE RACK, 2" HITCH RECEIVER	A	08/11/17	Pieces	\$527.60	
60103946	BOTTLE & CAGE W/ SPACERS AND HARDWARE	A	11/09/17	Pieces	\$19.00	
60103952	BOTTLE & CAGE W/ STRAPS	A	11/09/17	Pieces	\$7.00	
1152965	CLICK STRAP SET W/ ZIP TIES LARGE (12" PAD)	A	10/04/16	Pieces	\$86.00	
1152964	CLICK STRAP SET W/ ZIP TIES MEDIUM (10" PAD)	A	10/04/16	Pieces	\$80.00	
1152963	CLICK STRAP SET W/ ZIP TIES SMALL (8" PAD)	A	10/04/16	Pieces	\$75.00	
1153155	FOOTREST STRAP 2" PADDED	A	06/23/16	Pieces	\$40.00	
1166379	FORCE RX, CURVED LEG SUPPORT ASSEMBLY	E	04/05/16	Pieces	\$35.00	
1139799	HEART RATE MONITOR	A	01/01/15	Pieces	\$100.00	
1060638	HELMET, MEDIUM-LARGE	A	10/14/16	Pieces	\$75.00	
1061251	HELMET, SM-MED	A	10/14/16	Pieces	\$75.00	
1166628	MIRROR BRACKET ASM, CHAINGUARD MOUNT	F	09/22/17	Pieces	\$15.00	

Top End Wheelchair Service Part List: 60001574 FORCE RX

Service Part Item Group: **Accessories**

1153045	MIRROR, HANDPEDAL & CHAINRING MOUNT	B	10/10/17	Pieces	\$35.00	
1060642	SAFETY FLAG .25" 1/4" WHITE POLE	A	03/22/16	Pieces	\$15.00	
1156741	SAFETY FLAG HOLDER, FORCE	C	08/30/17	Pieces	\$18.00	
1068721	SAFETY LIGHT, FRONT CLEAR (2-MODE SETTING)	A	08/16/17	Pieces	\$24.40	
1060841	SAFETY LIGHT, REAR RED (2 MODE SETTING)	A	01/01/15	Pieces	\$24.40	
1181371	SPIRAL WRAP 1/8" BLACK 4 FOOT LENGTH	A	11/03/15	Pieces	\$4.00	
1166518	TOOL AND TIRE REPAIR KIT	A	01/01/15	Pieces	\$95.00	
1116580	TRAINING ROLLER, HANDCYCLE MAG RESIST, 26" & LARGER - WHEEL SIZE:	B	02/09/18	Pieces	\$244.98	
60001522	T-SHIRT, TOP END LOGO EXTRA LARGE	A	08/29/17	Pieces	\$19.85	
60001521	T-SHIRT, TOP END LOGO LARGE	A	08/30/17	Pieces	\$15.00	
60103944	WATER BOTTLE AND CAGE, W/ HARDWARE AND 1.0" CLAMP	A	11/08/17	Pieces	\$42.50	
1181553	WATER BOTTLE CAGE STRAP-ON ASSEMBLY	B	12/31/15	Pieces	\$37.00	
1166517	WATER BOTTLE ONLY	A	01/01/15	Pieces	\$8.00	
RACE4	WHEELBAG	A	01/01/15	Pieces	\$180.00	



Top End Wheelchair Service Part List: 60001574 FORCE RX

Service Part Item Group: Hardware

Item Number:	Description:	Rev:	Rev Date:	Unit:	Price:	Image:
1060752	BHCS M5 X 12MM SS	A	12/30/16	Pieces	\$0.50	
1152983	CABLE TIE: 8"X5/16" 120LBS (BLACK)	A	04/14/16	Pieces	\$0.50	
1195416	CLAMP ASM., 3/4" X 1", WHEEL LOCK	A	11/07/16	Pieces	\$15.00	
1139768	LOCKNUT, 10-32 THIN STAINLESS STEEL	A	11/03/16	Pieces	\$0.50	
1109805	NUT, M6-1 NYLOCK STAINLESS STEEL	A	04/03/17	Pieces	\$0.50	
1025195	NUT, 1/4-20 LOCK THIN	C	04/09/03	Pieces	\$0.50	
1139803	PLUG, 3/4" DOMED HEAD BLACK PLASTIC	A	01/01/15	Pieces	\$2.00	
1139804	PLUG, 7/8" DOMED HEAD BLACK PLASTIC	A	01/01/15	Pieces	\$2.00	
1139748	SCREW, 1/4-20 X 1" SHCS STAINLESS STEEL	A	11/03/16	Pieces	\$0.50	
1139749	SCREW, 10-32 X 3/4" BHCS STAINLESS STEEL	A1	04/10/17	Pieces	\$2.00	
1181560	SCREW, 10-32 X 3/8" BHCS STAINLESS STEEL W/PATCH	A	12/29/16	Pieces	\$0.50	
1061190	SCREW, M6 X 45MM SHCS ,STAINLESS STEEL	A	04/24/17	Pieces	\$2.00	
1139755	SCREW, M6-1 X 16MM SHCS SS	A	09/14/16	Pieces	\$0.50	
1060247	SCREW, M6-1 X 20MM SHCS SS	A	11/21/16	Pieces	\$1.50	
1060235	SCREW, M6-1 X 35MM SHCS SS	A	10/10/16	Pieces	\$2.00	
1023631	WASHER, #10 FLAT, BLACK	C	03/02/01	Pieces	\$0.06	



Top End Wheelchair Service Part List: 60001574 FORCE RX

Service Part Item Group: Hardware

1195175	WASHER, M5 FLAT 18-8 STAINLESS STEEL	A	08/15/16	Pieces	\$0.50
1195171	WASHER, M6 FLAT 18-8 STAINLESS STEEL	A	09/09/16	Pieces	\$0.50

