



## Invacare® AVIVA™ FX MPS Maxx

Modular Power Standing System

### en Power Wheelchair User Manual

This manual **MUST** be given to the user of the product.  
**BEFORE** using this product, this manual **MUST** be read and saved for  
future reference.



**Yes, you can.®**

---

# Contents

---

<b>1 General</b>	<b>5</b>		
1.1 Introduction	5		
1.2 Symbols in This Manual	5		
1.3 Compliance	6		
1.3.1 Product-Specific Standards	6		
1.4 Usability	6		
1.5 Warranty Information	7		
1.6 Service Life	7		
1.7 Limitation of Liability	7		
<b>2 Safety</b>	<b>8</b>		
2.1 General Safety Notes	8		
2.2 Safety Information on the Electrical System	11		
2.3 Safety Information on Electromagnetic Interference	12		
2.4 Safety Information on Driving and Freewheel Mode	13		
2.5 Safety Information With Regard to Care and Maintenance	15		
2.6 Safety Information Regarding Changes and Modifications to the Power Wheelchair	16		
2.7 Safety Information on Power Wheelchairs with a Lifter	17		
2.8 Safety Information for Modular Power Seating (MPS) System	18		
<b>3 Product Overview</b>	<b>21</b>		
3.1 Intended Use	21		
		3.1.1 Product Description	21
		3.1.2 Intended User	21
		3.1.3 Indications	21
		3.2 Type Classification	21
		3.3 Labels on Product	22
		3.4 Main Parts of Wheelchair	26
		3.5 User Inputs	26
		3.5.1 M290 Remote Attendant Control	26
		3.6 Power Positioning Functions	30
		3.6.1 Modular Power Standing (MPS) System	30
		3.7 Driving and Seating Limitations	31
		3.7.1 Driving Limitations	32
		3.7.2 Seating Limitations	33
<b>4 Accessories / Options</b>	<b>34</b>		
4.1 Posture Belts	34		
4.1.1 Types of Posture Belts	34		
4.1.2 Adjusting Posture Belt Correctly	35		
<b>5 Setup</b>	<b>36</b>		
5.1 General Setup Information	36		
5.2 Adjusting Standard Remote Holder	37		
5.3 Adjusting Swing Away Remote Holder	38		
5.4 Adjusting Quad Link Remote Holder	39		
5.5 Adjusting Maxx Resolve Swing-Away Remote Holder	40		
5.6 Adjusting Nucleus Midline Holder	42		
5.6.1 Adjusting Depth of Nucleus Midline Holder	42		

© 2024 Invacare Corporation

All rights reserved. Republication, duplication or modification in whole or in part is prohibited without prior written permission from Invacare. Trademarks are identified by ™ and ®. All trademarks are owned by or licensed to Invacare Corporation or its subsidiaries unless otherwise noted.

5.6.2	Adjusting Height of Nucleus Midline Holder	42	6.2	Before Driving for First Time	66
5.6.3	Adjusting Remote / Display Position	43	6.3	Parking and Stationary	66
5.7	Adjusting Swing-Away Mechanism	44	6.4	Getting in and out of Power Wheelchair	66
5.8	Adjusting Swing-Away Display Holder	45	6.4.1	Swivelling Remote to Side	66
5.9	Adjusting Manual Chin Control	45	6.4.2	Swivelling Nucleus Midline Holder to Side	68
5.9.1	Adjusting Extremity Control Joystick	46	6.4.3	Swivelling Swing-Away Display Holder to Side	69
5.9.2	Adjusting Egg Switch	46	6.4.4	Swivelling Chin Control to Side	69
5.10	Adjusting Head Array	47	6.4.5	Remove / Swing Away the Chest Bar	69
5.11	Adjusting Sip and Puff Head Array	47	6.4.6	Stowing the Knee Bolster Assembly	70
5.12	Adjusting Cantilever Flip-up Armrest	48	6.4.7	Information About Getting in and out	71
5.12.1	Arm Pad Installation / Adjustment	49	6.5	Taking Obstacles	71
5.13	Adjusting Hip Support with Quick Release	50	6.5.1	Maximum Obstacle Height	71
5.14	Adjusting Lateral Trunk Support	52	6.5.2	Safety Information When Taking Obstacles	71
5.15	Adjusting the Headrest	53	6.5.3	Correct Way to Take Obstacles	72
5.15.1	Auto-style Headrest Set-up and Installation	54	6.6	Driving up and down Gradients	73
5.15.2	Adjusting Elan Headrest Hardware	54	6.6.1	Negotiating Inclines	73
5.15.3	Adjusting Multi-axis Headrest Hardware	55	6.7	Reaching, Leaning and Bending	74
5.16	Adjusting the Height of the Backrest	56	6.8	Use on Public Roads	74
5.17	Adjusting the Chest Bar	57	6.9	Pushing the Power Wheelchair in Freewheel Mode	74
5.17.1	Adjusting Chest Bar Height	57	6.9.1	Disengaging Motors	75
5.17.2	Adjusting Chest Bar Depth	57	<b>7</b>	<b>Control System</b>	<b>76</b>
5.18	Adjusting Legrest	57	7.1	Control Protection System	76
5.18.1	Adjust the Height of the Footrest	57	7.1.1	Using Circuit Breaker	76
5.18.2	Adjust the Width of the Footrests	59	7.2	Batteries	77
5.18.3	Setting Height and Width of Calf Pad	59	7.2.1	General Information on Charging	77
5.19	Installing the Knee Bolster Assembly	60	7.2.2	General Instructions on Charging	77
5.19.1	Adjusting the Knee Bolster Assembly	62	7.2.3	Charging Batteries	78
5.19.2	Adjusting Knee Pad Width	65	7.2.4	Disconnecting Power Wheelchair after Charging	79
5.19.3	Adjusting Knee Pad Angle	65	7.2.5	Storage and Maintenance	79
5.19.4	Adjusting Eccentric Knee Pad Position	65	7.2.6	Instructions on Using Batteries	79
<b>6</b>	<b>Usage</b>	<b>66</b>	7.2.7	Transporting Batteries	80
6.1	Driving	66	7.2.8	General Instructions on Handling Batteries	80

7.2.9	Handling Damaged Batteries Correctly	81
<b>8</b>	<b>Transport</b>	<b>82</b>
8.1	General Information on Transport	82
8.2	Transferring Power Wheelchair to Vehicle	82
8.3	Transporting Power Wheelchair Without Occupant	83
<b>9</b>	<b>Maintenance</b>	<b>84</b>
9.1	Maintenance Introduction	84
9.2	Inspection Checks	84
9.2.1	Before Each Use of Power Wheelchair	85
9.2.2	Weekly	85
9.2.3	Monthly	86
9.2.4	Performance Troubleshooting	87
9.3	Wheels and Tyres	90
9.4	Short-Term Storage	90
9.5	Long-Term Storage	91
9.6	Cleaning and Disinfection	91
9.6.1	General Safety Information	91
9.6.2	Cleaning Intervals	92
9.6.3	Cleaning	92
9.6.4	Disinfection Instructions	93
9.7	Seating Module Lubrication	93
<b>10</b>	<b>After Use</b>	<b>95</b>
10.1	Reconditioning	95
10.2	Disposal	95
<b>11</b>	<b>Technical Data</b>	<b>96</b>
11.1	Technical Specifications	96
<b>12</b>	<b>Service</b>	<b>102</b>
12.1	Inspections Performed	102

# 1 General

## 1.1 Introduction

This user manual contains important information about the handling of the product. To ensure safety when using the product, read the user manual carefully and follow the safety instructions.

Only use this product if you have read and understood this manual. Seek additional advice from a healthcare professional who is familiar with your medical condition and clarify any questions regarding the correct use and necessary adjustment with the healthcare professional.

Note that there may be sections in this document, which are not relevant to your product, since this document applies to all available models (on the date of printing). If not otherwise stated, each section in this document refers to all models of the product.

The models and configurations available in your country can be found in the country-specific sales documents.

Invacare reserves the right to alter product specifications without further notice.

Before reading this document, make sure you have the latest version. You find the latest version as a PDF on the Invacare website. Previous product versions may not be described in this Manual's current revision. If you require assistance, please contact Invacare.

If you find that the font size in the printed document is difficult to read, you can download the PDF version from the website. The PDF can then be scaled on screen to a font size that is more comfortable for you.

For more information about the product, for example product safety notices and product recalls, contact your Invacare distributor. See addresses at the end of this document.

In case of a serious incident with the product, you should inform the manufacturer and the competent authority in your country.

## 1.2 Symbols in This Manual

Symbols and signal words are used in this manual and apply to hazards or unsafe practices which could result in personal injury or property damage. See the information below for definitions of the signal words.



### **DANGER!**

Indicates a hazardous situation that will result in serious injury or death if it is not avoided.



### **WARNING!**

Indicates a hazardous situation that could result in serious injury or death if it is not avoided.



### **CAUTION!**

Indicates a hazardous situation that could result in minor or slight injury if it is not avoided.



### **NOTICE!**

Indicates a hazardous situation that could result in damage to property if it is not avoided.



### **Tips and Recommendations**

Gives useful tips, recommendations, and information for efficient, trouble-free use.



### Tools

Identifies required tools, components and items which are needed to carry out certain work.

### Other Symbols

(Not applicable for all manuals)



### UK Responsible Person

Indicates if a product is not manufactured in the UK.



### Triman

Gives useful tips, recommendations, and information for efficient, trouble-free use.

## 1.3 Compliance

Quality is fundamental to the company's operation, working within the disciplines of ISO 13485.

This product features the CE mark, in compliance with the Medical Device Regulation 2017/745 Class I.

This product features the UKCA mark, in compliance with Part II UK MDR 2002 (as amended) Class I.

We are continuously working towards ensuring that the company's impact on the environment, locally and globally, is reduced to a minimum.

We only use REACH compliant materials and components.

We comply with the current environmental legislations WEEE and RoHS.

### 1.3.1 Product-Specific Standards

The product has been tested and conforms to EN 12184 (Electrically powered wheelchairs, scooters and their chargers) and all related standards.

When equipped with an appropriate lighting system, the product is suitable for use on public roads.

For further information about local standards and regulations, contact your local Invacare distributor. See addresses at the end of this document.

## 1.4 Usability

Only use a power wheelchair when it is in perfect working order. Otherwise, you might put yourself and others at risk.

The following list does not claim to be exhaustive. It is only intended to show some of the situations that could affect the usability of your power wheelchair.

In certain situations, you should immediately stop using your power wheelchair. Other situations allow you to use the power wheelchair to get to your provider.

### **You should immediately stop using your power wheelchair if its usability is restricted due to:**

- Unexpected driving behaviour
- brake failure

### **You should immediately contact an authorised Invacare provider if the usability of your power wheelchair is restricted due to:**

- the lighting system (if fitted) failing or being defective
- reflectors falling off
- worn thread or insufficient tire pressure
- damage to the armrests (e.g. torn armrest padding)
- damage to the legrest hangers (e.g. missing or torn heel straps)
- damage to the postural belt
- damage to the joystick (joystick cannot be moved into the neutral position)
- cables that are damaged, kinked, pinched or have come loose from the fixation
- the power wheelchair drifting when braking
- the power wheelchair pulling to one side when moving
- unusual sounds developing or occurring

Or if you have the feeling that something is wrong with your power wheelchair.

## 1.5 Warranty Information

We provide a manufacturer's warranty for the product in accordance with our General Terms and Conditions of Business in the respective countries.

Warranty claims can only be made through the provider from whom the product was obtained.

## 1.6 Service Life

We estimate a service life of five years for this product, provided it is used in strict accordance with the intended use as set out in this document and all maintenance and service requirements are met. The estimated service life can be exceeded if the product is carefully used and properly maintained, and provided technical and scientific advances do not result in technical limitations. The service life can also be considerably reduced by extreme or incorrect usage. The fact that we estimate a service life for this product does not constitute an additional warranty.

## 1.7 Limitation of Liability

Invacare accepts no liability for damage arising from:

- Non-compliance with the user manual
- Incorrect use
- Natural wear and tear
- Incorrect assembly or set-up by the purchaser or a third party
- Technical modifications
- Unauthorised modifications and/or use of unsuitable spare parts

## 2 Safety

### 2.1 General Safety Notes

**WARNING!****Risk of Serious Injury or Damage**

Improper use of this product may cause injury or damage.

- If you are unable to understand the warnings, cautions or instructions, contact a health care professional or provider before attempting to use this equipment.
- Do not use this product or any available optional equipment without first completely reading and understanding these instructions and any additional instructional material such as user manual, service manual or instruction sheet supplied with this product or optional equipment.

**DANGER!****Risk of Death, Serious Injury, or Damage**

Lighted cigarettes dropped onto an upholstered seating system can cause a fire resulting in death, serious injury, or damage. Power wheelchair occupants are at particular risk of death or serious injury from these fires and resulting fumes because they may not have the ability to move away from the power wheelchair.

- DO NOT smoke while using this power wheelchair.

**WARNING!****Risk of Serious Injury or Damage**

Storing or using the power wheelchair near open flame or combustible products can result in serious injury or damage.

- Avoid storing or using the power wheelchair near open flame or combustible products.

**WARNING!****Risk of damage or injury if power wheelchair is accidentally set into motion**

- Switch the power wheelchair off before you get in, get out or handle unwieldy objects.
- When the drive is disengaged, the brake inside the drive is deactivated. For this reason, pushing the power wheelchair by an attendant is only recommended on flat surfaces, never on gradients. Never leave your power wheelchair on a gradient with its motors disengaged. Always re-engage the motors immediately after pushing the power wheelchair (refer to *6.9 Pushing the Power Wheelchair in Freewheel Mode*, page 74).

**WARNING!****Risk of Injury, Damage or Death**

Improper monitoring or maintenance may cause injury, damage or death due to ingestion or choking on parts or materials.

- Closely supervise children, pets, or people with physical / mental disabilities.





**WARNING!**

**Risk of Death, Serious Injury or Damage**

Risk of entrapment and strangulation when loose personal belongings (e.g. jewellery, scarfs) get caught by moving or protruding parts.

- Make sure that any loose items are clear of moving parts of the power wheelchair, e.g. wheels or powered seating components.
- Keep your hands, clothing and all other objects away from wheels or powered seating components when they are in operation.
- Power off power wheelchair immediately to stop any movement.



medication or alcohol. If necessary, the power wheelchair must be operated by an attendant who is physically and mentally able.



**WARNING!**

**Risk of injury if the power wheelchair is switched off while driving, for example by pressing the On/Off Button or disconnecting a cable, due to it coming to an abrupt, sharp stop**

- If you have to brake in an emergency, simply release the joystick which will bring you to a halt (refer to the remote user manual for more information).



**WARNING!**

**Risk of injury when transferring power wheelchair to a vehicle for transport with the occupant seated in it**

- It is always better to transfer the power wheelchair to a vehicle without the occupant seated in it.
- If the power wheelchair needs to be loaded up a ramp together with its driver, ensure that the ramp does not exceed the rated slope (refer to *11.1 Technical Specifications, page 96*).
- If the power wheelchair does need to be loaded using a ramp which exceeds the rated slope (refer to *11.1 Technical Specifications, page 96*), then you must use a winch. An attendant can safely monitor and assist the loading process.



**WARNING!**

**Risk of Death, Serious Injury or Damage**

Improper routing of cables may cause a tripping entanglement or strangulation hazard that may result in death, serious injury or damage.

- Ensure all cables are routed and secured properly.
- Ensure there are no loops of excess cable extending away from the wheelchair.



**WARNING!**

**Risk of injury if the power wheelchair is driven when ability to operate a vehicle is impaired by medication or alcohol**

- Never drive the power wheelchair under the influence of



- As an alternative you can use a platform lift. Ensure that the total weight of the power wheelchair including the user does not exceed the maximum permissible weight for the platform lift or winch if you are using.

**WARNING!****Risk of falling out of the power wheelchair**

- Do not slide forward on the seat, do not lean forward between your knees, do not lean backwards out over the top of the backrest, for example to reach an object.
- If a posture belt is installed, it should be correctly adjusted and used each time you use the power wheelchair.
- When transferring to a different seat, position the power wheelchair as close as possible to the new seat.

**CAUTION!****Risk of injury if maximum permissible load is exceeded**

- Do not exceed the maximum permissible load (refer to *11.1 Technical Specifications, page 96*).
- The power wheelchair is only designed for use by a single occupant whose maximum weight does not exceed the maximum permissible load of the device. Never use the power wheelchair to transport more than one person.

**CAUTION!****Risk of injury due to wrong lifting or dropping of heavy components**

- When maintaining, servicing or lifting any part of your power wheelchair, take into account the weight of the individual components especially the batteries. Be sure at all times to adopt the correct lifting posture and ask for assistance if necessary.

**CAUTION!****Risk of injury by moving parts**

- Make sure that no injury is incurred by moving parts of the power wheelchair, like wheels or one of the lifter modules (if fitted), especially when children are around.

**CAUTION!****Risk of injury from hot surfaces**

- Do not leave the power wheelchair in direct sunlight for prolonged periods. Metal parts and surfaces such as the seat and armrests can become very hot.

**CAUTION!****Risk of fire or breaking down due to electric devices being connected**

- Do not connect any electric devices to your power wheelchair that are not expressly certified by Invacare for this purpose. Have all electrical installations done by your authorised Invacare provider.

## 2.2 Safety Information on the Electrical System



### **WARNING!**

#### **Risk of death, serious injury or damage**

Misuse of the power wheelchair may cause the power wheelchair to start smoking, sparking, or burning. Death, serious injury, or damage may occur due to fire.

- DO NOT use the power wheelchair other than its intended purpose.
- If the power wheelchair starts smoking, sparking, or burning, discontinue using the power wheelchair and seek service IMMEDIATELY.



### **WARNING!**

#### **Risk of death or serious injury**

Electric shock can cause death or serious injury

- To avoid electric shock, inspect plug and cord for cuts and / or frayed wires. Replace cut cords or frayed wires immediately.



### **WARNING!**

#### **Risk of death or serious injury**

Failure to observe these warnings can cause an electrical short resulting in death, serious injury, or damage to the electrical system.

- The POSITIVE (+) RED battery cable MUST connect to the POSITIVE (+) battery terminal(s) / post(s).



- The NEGATIVE (-) BLACK battery cable MUST connect to the NEGATIVE (-) battery terminal(s) / post(s).
- NEVER allow any of your tools and / or battery cable(s) to contact BOTH battery post(s) at the same time. An electrical short may occur and serious injury or damage may occur.
- Install protective caps on positive and negative battery terminals.
- Replace cable(s) immediately if cable(s) insulation becomes damaged.
- DO NOT remove fuse or mounting hardware from POSITIVE (+) red battery cable mounting screw.



### **WARNING!**

#### **Risk of death, serious injury, or damage**

Corroded electrical components due to water or liquid exposure can result in death, serious injury, or damage.

- Minimize exposure of electrical components to water and / or liquids.
- Electrical components damaged by corrosion MUST be replaced immediately.
- Power wheelchairs that are frequently exposed to water / liquids may require replacement of electrical components more frequently.

**WARNING!****Risk of fire**

Switched on lamps produce heat. If you cover the lamps with fabrics such as clothes, there is a risk that the fabric may catch fire.

- NEVER cover the light system with fabric.

**WARNING!****Risk of death, serious injury or damage when carrying along oxygen systems**

Textiles and other materials that normally would not burn are easily ignited and burn with great intensity in oxygen enriched air.

- Check the oxygen tubing daily, from the cylinder to the delivery site, for leaks and hold away from electrical sparks and any source of ignition.

**WARNING!****Risk of injury or damage due to electrical shorts**

Connector pins on cables connected to the power module can still be live even when the system is off.

- Cables with live pins should be connected, restrained or covered (with non-conductive materials) so that they are not exposed to human contact or materials that could cause electrical shorts.



- When cables with live pins have to be disconnected, for example, when removing the bus cable from the remote for safety reasons, make sure to restrain or cover the pins (with non-conductive materials).

**NOTICE!**

A failure in the electric system can lead to unusual behavior such as continuous light, no light, or noises from the magnetic brakes.

- If a failure exists, switch off the remote and switch it on again.
- If a failure still exists, then disconnect or remove the power source. Depending on the power wheelchair model, you can either remove the battery packs or disconnect the batteries from the power module. If in doubt which cable to disconnect, contact your provider.
- In any case, contact your provider.

## 2.3 Safety Information on Electromagnetic Interference

This powered power wheelchair was successfully tested in accordance with International standards as to its compliance with Electromagnetic Interference (EMI) regulations. However, electromagnetic fields, such as those generated by radio and television transmitters, and cellular phones can influence the functions of powered power wheelchairs.

Also, the electronics used in our power wheelchairs can generate a low level of electromagnetic interference, which however will remain within the tolerance permitted by law. For these reasons we ask you to please observe the following precautions:



**WARNING!**

**Risk of malfunction due to electromagnetic interference**

- Do not switch on or operate portable transceivers or communication devices (such as radio transceivers or cellular phones) when the power wheelchair is switched on.
- Avoid getting near strong radio and television transmitters.
- In case the power wheelchair should be set in motion unintentionally or the brakes are released, switch it off immediately.
- Adding electrical accessories / options and other components or modifying the power wheelchair in any way can make it susceptible to electromagnetic interference. Keep in mind that there is no sure way to determine the effect such modifications will have on the overall immunity of the electronic system.
- Report all occurrences of unintentional movement of the power wheelchair, or release of the electric brakes to the manufacturer.



**DANGER!**

**Risk of death, serious injury, or damage**

- Malfunctioning joystick could cause unintended / erratic movement resulting in death, serious injury, or damage
- If unintended / erratic movement occurs, stop using the wheelchair immediately and contact a qualified technician.



**WARNING!**

**Risk of serious injury or damage**

- Improper positioning while leaning or bending could cause the wheelchair to tip forward resulting in serious injury or damage
- To assure stability and proper operation of your power wheelchair, you must at all times maintain proper balance. Your power wheelchair has been designed to remain upright and stable during normal daily activities as long as you DO NOT move beyond the centre of gravity.
  - DO NOT lean forward out of the power wheelchair any further than the length of the armrests.
  - DO NOT attempt to reach objects if you have to move forward in the seat or pick them up from the floor by reaching down between your knees.

**WARNING!****Risk of breaking down in adverse weather conditions, i.e. extreme cold, in an isolated area**

- If you are a user with severely limited mobility, we advise that in the case of adverse weather conditions DO NOT attempt a journey without an accompanying attendant.

**WARNING!****Risk of injury if the power wheelchair tips over**

- Inclines and declines can only be travelled up to the maximum safe slope (refer to *11.1 Technical Specifications, page 96*).
- Always return the backrest of your seat or the seat tilt to an upright position before ascending slopes. We recommend that you position the seat backrest and the seat tilt (if fitted) slightly to the rear before descending slopes.
- Only ever drive downhill at a maximum of 2/3 of the top speed.
- Avoid abrupt braking or accelerating on gradients.
- If at all possible, avoid driving on wet, slippery, icy, or oily surfaces (such as snow, gravel, ice etc.) where there is a risk of you losing control over the vehicle, especially on a gradient. This may include certain painted or otherwise treated wood surfaces. If driving on such a surface is inevitable, then always drive slowly and with the utmost caution.



- Never attempt to overcome an obstacle when on an uphill or downhill gradient.
- Never attempt to drive up or down a flight of steps with your power wheelchair.
- When overcoming obstacles, always observe the maximum obstacle height and information about overcoming obstacles (refer to *6.5 Taking Obstacles, page 71*).
- Avoid shifting your centre of gravity as well as abrupt joystick movements and changes of direction when the power wheelchair is in motion.
- Never use the power wheelchair to transport more than one person.
- Do not exceed the overall maximum permissible load or the maximum load per axle (refer to *11.1 Technical Specifications, page 96*).
- Note that the power wheelchair will brake or accelerate if you change the driving mode whilst the power wheelchair is in motion.

**WARNING!****Risk of injury if your foot slides off the footrest and gets caught underneath the power wheelchair when it is in motion**

- Make sure each time before you drive the power wheelchair that your feet are squarely and securely in place on the footplates, and that both legrests are properly locked into place.



**WARNING!**

**Risk of injury if you collide with an obstacle when driving through narrow passages such as doorways and entrances**

- Drive through narrow passages in the lowest driving mode and with due caution.



**WARNING!**

**Risk of injury**

If your power wheelchair has been fitted with elevating legrests, there is a risk of personal injury and damage to the power wheelchair if you drive the power wheelchair with the legrests raised.

- To avoid unwanted displacement of the power wheelchair centre of gravity to the front (especially when travelling downhill) and in order to avoid damage to the power wheelchair, elevating legrests must always be lowered during normal travelling.



**WARNING!**

**Tipping hazard if antitippers are removed, damaged or changed to a position different to the factory settings**

- Antitippers should only ever be removed for dismantling the power wheelchair for transport in a vehicle or for storage.
- The antitippers must always be fitted if the power wheelchair is being used.



**WARNING!**

**Risk of tipping**

Antitippers (stabilizers) are only effective on firm ground. They sink in on soft ground such as grass, snow or mud if the power wheelchair rests itself on them. They lose their effect and the power wheelchair can tip over.

- Only drive with extreme care on soft ground, especially during uphill and downhill journeys. In the process pay increased attention to the tip stability of the power wheelchair.

## 2.5 Safety Information With Regard to Care and Maintenance



**WARNING!**

**Risk of death, serious injury, or damage**

Incorrect repair and/or servicing of this power wheelchair performed by users/caregivers or unqualified technicians can result in death, serious injury, or damage.

- DO NOT attempt to carry out maintenance work that is not described in this user manual. Such repair and/or service MUST be performed by a qualified technician. Contact a provider or Invacare technician.

**CAUTION!****Risk of accident and loss of warranty if maintenance is insufficient**

- For reasons of safety and in order to avoid accidents which result from unnoticed wear, it is important that this power wheelchair undergoes an inspection once every year under normal operating conditions (see inspection plan contained in service instructions).
- Under difficult operating conditions such as daily travel on steep slopes, or in the case of use in medical care cases with frequently changing power wheelchair users, it would be expedient to carry out intermediate checks on the brakes, accessories / options and running gear.
- If the power wheelchair is to be operated on public roads, the vehicle driver is responsible for ensuring that it is in an operationally reliable condition. Inadequate or neglected care and maintenance of the power wheelchair will result in a limitation of the manufacturer's liability.

## 2.6 Safety Information Regarding Changes and Modifications to the Power Wheelchair

**CE marking of the power wheelchair:**

- The conformity assessment / CE marking was carried out according to the respective valid regulations and only applies to the complete product.

**WARNING!****Risk of serious injury or damage**

Use of incorrect or improper replacement (service) parts may cause injury or damage

- Replacement parts **MUST** match original Invacare parts.
- Always provide the wheelchair serial number to assist in ordering the correct replacement parts.

**CAUTION!****Risk of injuries and damage to power wheelchair due to unapproved components and accessories / options**

Seating systems, additions and accessories / options which have not been approved by Invacare for use with this power wheelchair can affect the tipping stability and increase tipping hazards.

- Only ever use seating systems, additions and accessories / options which have been approved by Invacare for this power wheelchair.





Seating systems which are not approved by Invacare for use with this power wheelchair do not, under certain circumstances, comply with the valid standards and could increase the flammability and the risk of skin irritation.

- Only use seating systems that have been approved by Invacare for this power wheelchair.



**CAUTION!**  
**Risk of injuries and damage to power wheelchair due to unapproved components and accessories / options**

Electrical and electronic components which have not been approved by Invacare for use with this power wheelchair can cause fire hazards and lead to electromagnetic damage.

- Only ever use electrical and electronic components which have been approved by Invacare for this power wheelchair.

Batteries which have not been approved by Invacare for use with this power wheelchair can cause chemical burns.

- Only ever use batteries which have been approved by Invacare for this power wheelchair.



**CAUTION!**  
**Risk of injuries, and damage to the power wheelchair, if unapproved backrests are used**

A retrofitted backrest which is not approved by Invacare for use with this power wheelchair may overload the backrest



tube and thus increase the risk of injuries and of damage to the power wheelchair.

- Please contact your Invacare specialist provider who will perform risk analyses, calculations, stability checks etc. to ensure that the backrest can be used safely.



**Important information about maintenance work tools**

Some maintenance work which is described in this manual and can be carried out by the user without problems require the correct tools for proper work. If you do not have the correct tool available we do not recommend that you try to carry out the relevant work. In this case, we urgently recommend that you contact an authorised specialist workshop.

## 2.7 Safety Information on Power Wheelchairs with a Lifter



**WARNING!**  
**Risk of injury by moving parts**

- Never let objects get caught in the space underneath a raised lifter.
- Make sure that neither you nor anyone else is injured by placing hands, feet or other body extremities under the raised seat.



- Should you not be able to view under the seat, for example, due to limited manoeuvrability, turn the wheelchair once on its own axle before you lower the seat. This will allow you to make sure that nobody is located in the danger zone.

**CAUTION!****Risk of malfunction of the lifter module**

- Inspect the lifter module at regular intervals to make sure there are no foreign objects or visible damage, and to make sure the electric plugs are firmly inserted into their sockets.

**CAUTION!****Damage to power wheelchair caused by one-sided loading on lifter pillar**

- One-sided loading occurs if the seat is raised and / or tilted. Always return your seat backrest to the upright position and the seat tilting to the horizontal position before ascending slopes. Never subject the lifter pillar to continuous single-sided loading. The raising and tilting function of the seat only provides additional rest positions.

**CAUTION!****Risk of injury if the power wheelchair tips over**

- Never exceed the maximum permissible load (refer to *11.1 Technical Specifications, page 96*).



- Avoid dangerous driving situations when the lifter is in a raised position, such as trying to overcome obstacles like curbs or driving up or down steep gradients.
- Never lean out of the seat when the lifter is raised.
- Inspect the lifter module at least once a month to make sure the automatic speed reduction function, which reduces the speed of the power wheelchair when the lifter is raised, is working properly (refer to *3.7 Driving and Seating Limitations, page 31*). Notify your authorised provider immediately if it is not working properly.

**Important information regarding speed reduction with raised lifter**

If the lifter has been raised above a certain point, the drive electronics considerably reduces the speed of the wheelchair. If speed reduction has been activated, drive mode can only be used to carry out minor movements of the power wheelchair and not for regular driving. To drive normally, lower the lifter until the speed reduction has been deactivated again, refer to *3.7 Driving and Seating Limitations, page 31*.

## 2.8 Safety Information for Modular Power Seating (MPS) System

**WARNING!****Risk of injury by moving parts**

- Never let objects get caught in the space underneath a raised MPS system.



- Make sure that neither you nor anyone else is injured by placing hands, feet or other body extremities under the raised seat.
- Should you not be able to view under the seat, for example, due to limited manoeuvrability, turn the wheelchair once on its own axle before you lower the seat. This will allow you to make sure that nobody is located in the danger zone.



**WARNING!**

**Risk of Tipping**

The power wheelchair may tip over when you change its stability characteristics by changing your seating position.

- Determine and establish your personal safety limits by practicing bending, reaching and transferring activities in the presence of a qualified healthcare professional before attempting active use of the wheelchair.
- Consider all personal gear and accessories (backpacks, vent systems, extra batteries, etc.) that will be carried on the wheelchair. For example, a loaded backpack, attached to the back of the seating system, can significantly reduce the rearward stability of your wheelchair.
- Always shift your weight in the direction you are turning. Shifting weight in the opposite direction of the turn may compromise stability of the wheelchair base, causing it to tip over.
- All seating systems are equipped with drive lockouts.



Make certain this is set so as not to compromise your stability while driving (refer to *3.7 Driving and Seating Limitations, page 31*).

- The wheelchair has a programmable controller which allows adjustment of the maximum acceleration and deceleration of the wheelchair. Make sure that these are set to an appropriate level for the system and for you, the user.
- When operating in reduced speed drive or anti-tipper lockout, always travel on a smooth level surface to ensure the wheelchair's stability is not compromised.
- Ensure all medical conditions are considered when setting up your wheelchair. Involuntary muscle movement such as spasms may affect the stability of the wheelchair, especially when the seating system is in a tilted or reclined position.
- When a system is fully tilted, reclined or in stand function the front wheels of the wheelchair should never come off the ground. If this occurs, please contact your authorised Invacare provider immediately to resolve the issue.



**CAUTION!**

**Risk of injury if the wheelchair tips over**

- Never exceed the maximum permissible load (refer to *11.1 Technical Specifications, page 96*).
- Avoid dangerous driving situations when the MPS system is raised, such as trying to overcome obstacles



like curbs, driving up or down steep gradients or driving over uneven ground.

- Inspect all modules at least once a month to make sure the automatic speed reduction function, which reduces the speed of the wheelchair when the MPS system is raised, is working properly refer to *3.7 Driving and Seating Limitations, page 31*). Notify your authorised provider immediately if it is not working properly.



**CAUTION!**  
**Risk of injury**

The user can fall out of the seat if the restraining systems are not used.

- Only raise the MPS system if all restraining systems – restraining belt and knee belt / clamp – have been applied and locked properly.



**CAUTION!**  
**Risk of injury**

The chest belt lock can lose strength due to soiling or wear.

- The belt lock hook strap must not be soiled or clogged with fluff, fabric residue or similar foreign bodies. It must be in a clean, undamaged condition.
- The belt lock loop strap must not be frayed or otherwise damaged or soiled.
- The seams which fix the hook-and-loop straps to the belt must be in perfect undamaged condition. The hook-and-loop straps may not loosen themselves.



- When locking the belt, the hook- and loop straps must completely overlap each other. The strength of the lock is considerably decreased if the hook- and loop straps only partially overlap.
- To check the functionality of the belt, the user should lean forwards and exert pressure on the belt when the MPS system is lowered and the belt is fastened. The belt lock must not loosen or release when this is done. In doing so, the user must be safeguarded by an attendant so that he cannot fall forwards out of the power wheelchair if the lock should release.



**CAUTION!**  
**Risk of malfunction of the lifter module**

- Inspect the lifter module at regular intervals to make sure there are no foreign objects or visible damage, and to make sure the electric plugs are firmly inserted into their sockets.



**NOTICE!**

- One-sided loading occurs if the seat is raised and / or tilted. Always return your seat backrest to the upright position and the seat tilting to the horizontal position before ascending slopes. Never subject the lifter pillar to continuous single-sided loading. The raising and tilting function of the seat only provides additional rest positions.

## 3 Product Overview

### 3.1 Intended Use

#### 3.1.1 Product Description

The AVIVA FX MPS Maxx is a front wheel drive power wheelchair established with a modular power standing system.

#### 3.1.2 Intended User

This power wheelchair was designed for adults and adolescents whose ability to walk is impaired, but who are still in terms of their eyesight and physically and mentally able to operate an electric power wheelchair.

#### 3.1.3 Indications

The use of this power wheelchair is recommended for the following indications:

- The inability or a greatly restricted ability to walk within the scope of the basic requirement to be able to move within one's own four walls.
- The need to leave the dwelling place in order to get some fresh air during a short walk or to reach those places generally to be found at close distance to the dwelling and where everyday business is carried out.

Provision of power wheelchairs for interior and exterior areas is advisable if the use of hand-operated wheelchairs is no longer possible on account of the disability, yet proper operation of an electromotive drive unit is still practicable.

### Contraindications

- Range of motion of the hips, knees & ankles (bilaterally) should be within functional limits for standing as determined by a healthcare professional. Limitations of range of motion can result from many conditions (spasticity, heterotrophic ossification, hip dislocation, etc.) which can cause orthopedic changes and prevent an ergonomic standing posture.
- Blood pressure: Decreased muscle tone can make it difficult for blood to circulate from the lower extremities back to the lungs and heart. A healthcare professional should monitor for orthostatic hypotension, elevated heart rate or other cardiovascular conditions.
- Bone density: If the user has not been ambulatory or fully weight-bearing for more than six months, it is recommended that a bone density assessment / review be performed to ensure that the long bones of the lower extremities will be able to physically support their weight in a standing position. Generally speaking, the longer the amount of time since a person has been ambulatory, the greater the risk for bone mineral loss and decreased bone density.







Other contraindications may exist. A healthcare professional must be consulted in determining each individual's indications and contraindications for use of an assisted standing device.



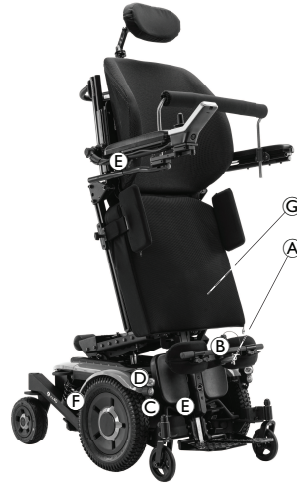



### 3.2 Type Classification

This vehicle has been classified according to EN 12184 as a **class B mobility product** (for indoor and outdoor areas). It is therefore compact and agile enough for indoor areas, but also able to overcome many obstacles in outdoor areas.











### 3.3 Labels on Product

















<p>(A)</p>		<p>Identification of the ON/OFF position of the circuit breaker switch (on the left side of power wheelchair). For details see below.</p>
<p>(B)</p>		<p>Indication to stowe the mounting bar, when not in use.</p> <p> The colour of the symbol background is orange on product labels.</p>
<p>(C)</p>		<p>Identification label sticker on the chassis at the right. For details see below.</p>

D		<p>Warning that the power wheelchair may not be used as a vehicle seat. This power wheelchair does not satisfy the requirements of ISO 7176-19.</p> <p> The colour of the symbol background is blue on product labels. The colour of the circle with diagonal bar is red on product labels.</p>
E		<p>Indication of pinch points that could occur on the power wheelchair.</p> <p> The colour of the symbol background is yellow on product labels.</p>
F		<p>Identification of the position of the coupling lever for driving and push operation (only the right side visible in the picture). For details see below.</p>
G		<p>Warning regarding the use of the lifter. For details see below.</p> <p> The colour of the rectangles and diagonal bars is red on product labels.</p>

### Explanation of Symbols on Labels

	Manufacturer		Unique Device Identification
	Date of manufacture		Battery type
	Medical device		Factory setting
	European Conformity		Serial number
	UK Conformity Assessed		Maximum speed

	QR code contains link to user manual		Rated slope
	Read the user manual		Unladen weight
	WEEE Conformity		Maximum user weight

	Do not lean out when the lifter is raised!		Do not drive up or down slopes when the lifter is raised!
	Do not allow any body parts to get under a raised seat!		Never drive with two people!
	Never drive over uneven surfaces when the lifter is raised!		
	<p>This symbol indicates the “Drive” position of the coupling lever. In this position the motor is engaged and the motor brakes are operational. You can drive the power wheelchair.</p> <ul style="list-style-type: none"> <li>Note that for driving purposes both motors must always be engaged.</li> </ul>		
	<p>This symbol indicates the “Push” position of the coupling lever. In this position the motor is disengaged and the motor brakes are not operational. The power wheelchair can be pushed by an attendant and the wheels turn freely.</p> <ul style="list-style-type: none"> <li>Note that the remote must be switched off.</li> <li>Also refer to <i>6.9 Pushing the Power Wheelchair in Freewheel Mode</i> , page 74.</li> </ul>		
	<p>This symbol indicates the OFF position of the circuit breaker switch. In this position the battery source is isolated and the power wheelchair cannot be operated or charged.</p>		
	<p>This symbol indicates the ON position of the circuit breaker switch. In this position the battery source is connected and the power wheelchair can be operated or charged.</p>		





This symbol indicates the circuit breaker.



Read the user manual. This symbol appears on different labels and positions.

### 3.4 Main Parts of Wheelchair





- Ⓐ Headrest
- Ⓑ Chest strap (not shown)
- Ⓒ Lateral support (not shown)
- Ⓓ Backrest
- Ⓔ Chest bar
- Ⓕ Armrest
- Ⓖ Remote
- Ⓗ Postural belt (not shown)
- Ⓘ Hip support
- Ⓝ Knee pad
- Ⓚ Legrest

### 3.5 User Inputs

Your power wheelchair may be fitted with one of several different user inputs. For information on the different functions and how to operate a particular user input, refer to its corresponding user manual (enclosed).

#### 3.5.1 M290 Remote Attendant Control

The stand function — and the other power positioning functions — can be operated by a M290 Remote Attendant Control mounted at the rear of the seating system. The M290 Remote Attendant Control has a LCD display along with a directional key pad, which allows attendants to select and operate power positioning functions.

-  The main remote must be powered up to enable the M290 Remote Attendant Control.
-  When not in use, the display of the M290 Remote Attendant Control enters sleep mode after several seconds. To activate the M290 Remote Attendant Control again, touch the display or press the On or Off function arrow.

#### Overview M290 Remote Attendant Control



- Ⓐ Left / Right arrows
- Ⓑ Up /Down arrow
- Ⓒ Power positioning function
- Ⓓ Power positioning function icon
- Ⓔ Settings icon

## Operating Seating Functions

1. *Fig. 3-1 Tilt function serves as an example.*



Use left / right touch screen arrows (A) to scroll through available power positioning functions.



The colour of the function changes from orange to green.

- 2.



If desired seating function shows up, press and hold up or down arrows (B) to operate power positioning function to desired position.



The direction of travel is indicated on the display.



The colour of the status bar (top of display) indicates the drive function:

- green: normal drive function
- orange: drive slowdown
- red: drive lockout

## Enter Program Mode



Tap Settings Icon button (A).



Enter password 1234 (B) and tap right arrow button (C) to open Program Mode.

## Overview Program Mode



- (A) Adjusting actuator speed
- (B) Adjusting tilt function
- (C) Adjusting time / date
- (D) Adjusting stand function
- (E) Return to Home / previous menu
- (F) Go to next menu

## Adjust Actuator Speed

- 

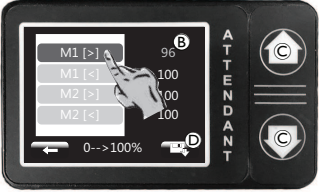
1. Select depending programming option. Tap on button **A** to open actuator speed menu.
- 

2. Tap on desired actuator (> = extend < = retract) to change the value **B** by pressing up or down arrows **C**. Tap on button **D** to save after every adjustment.
- 

3. Successful saving is displayed by "Ok!". Tap button **E** to return to home screen.

## Adjust Tilt Function

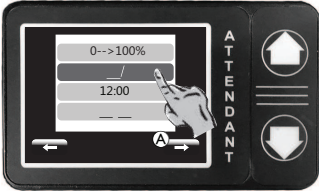
- 

1. Select depending programming option. Tap on button **A** to open actuator speed menu.
- 

2. Tap desired button to change: **B** Home position can be adjusted by pressing buttons **E**. **C** sets maximum backrest angle by pressing buttons **E**. **D** resets the maximum backrest angle. Tap button **C** to save after every adjustment. **F** always shows the current value of the backrest angle.
- 

3. Successful saving is displayed by "Ok!". Tap button **H** to return to home screen.

## Adjust Time and Date

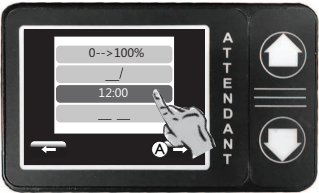
- 

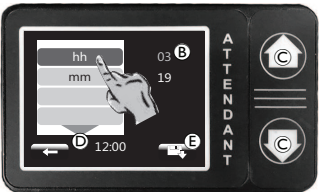
Select depending programming option. Tap on button **A** to open time / date menu.
- 

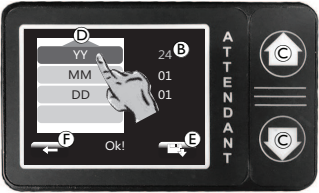
Tap on desired programming function to change the value **B** by pressing up or down arrows **C**.  
Tap on button **E** to save after every adjustment.  
Tap on arrow **D** to open date menu.
- 



Tap on desired programming function to change the value **B** by pressing up or down arrows **C**.  
Tap on button **E** to save after every adjustment. Tap on arrow **D** to open time menu.  
Successful saving is displayed by "Ok!".  
Tap button **F** to return to home screen.

## Adjust Stand Function

- 

Select depending programming option. Tap on button **A** to open stand function menu.
- 

Tap on desired programming function to change the value **B** by pressing up or down arrows **C**.  
Tap on button **D** to save adjustment.

 The value **A** is a reference for the position.
- 

Successful saving is displayed by "Ok!".  
Tap button **E** to return to home screen.

## 3.6 Power Positioning Functions

The seating system offers the following functions:

### MPS Stander system:

A multi actuator system to allow the user to adapt their seating system to transition from seated to standing.

### Ultra Low Maxx CG tilt:

0 – 45° of seat tilt which features centre of gravity shift for added stability.

### Power Recline with ESR:

170° powered backrest recline with extended shear reduction, reduces any shear between the seating system and the user.

### Seat riser:

The powered seat riser system allows the user to raise their seating system by 178 mm.

### Legrests:

Powered elevating belt drive central articulating foot platform allowing the user to angle and adjust their leg position.

### 3.6.1 Modular Power Standing (MPS) System



#### **WARNING!**

#### **Risk of Injury or Death**

Failure to utilise the MPS system safety accessories provided and / or failure to follow proper adjustment procedures can result in serious injury or death.

- Always wear postural belt when seated in the wheelchair.
- Always ensure the chest strap is properly adjusted and



- secured before transitioning into standing position.
- Always ensure the chest bar is properly adjusted and locked into position before transitioning into standing position.
- Always ensure the knee bolster is properly adjusted and locked into position before transitioning into standing position.

The stand function allows the seating system to be raised from a seated position into an upright position.

The stand function transitions the seating system from a standard seated position into a full upright standing position.



When transitioning to a standing position, the seating system first goes to a pre-tilted position before the seat begins to shift upward into the full upright (stand) position.

When returning to the home position from the standing position, the seating system travels (and self adjusts) over the identical range of motion but in the reverse sequence.

## Lockout and Limits

### Tilt Function

The tilt function remains locked at all times throughout the stand function.

-  If the seating system is already tilted when the stand function is activated, the seat automatically returns to the tilt home position before the seat begins to shift upwards into the standing position.

### Recline Function

The recline function still operates when the system is at full stand, however the range of available recline is minimised, allowing for approx. 10° of recline angle adjustment in the standing position.

### Powered Central Legrest

If the powered central legrest is out of home (extended) position before activating the stand function, the powered central legrest automatically returns to its home position before the seat begins to shift upwards into the standing position.

-  The AVIVA MPS system uses a mechanism to lockout the front castor suspension and stabilise the wheelchair base as the seating system transitions into the full standing position. The front castor lockout is controlled via the powered central legrest. If power to the legrest is disconnected for any reason, an electronic protection system is in place that locks the stand function until the issue is corrected.

## 3.7 Driving and Seating Limitations



### DANGER!

#### Risk of Severe Injury or Death

The angle at which the limit switches/lockouts are set is critical to the safe operation of the system.

- Invacare will not be liable for any injuries or damage sustained when adjustments are made beyond the factory recommended settings.
- To ensure proper set-up, adjustments to lockouts and limits should only be performed by a qualified technician.
- Never exceed the maximum recommended limits. Lockouts and limit switches should be set up to best meet the needs of the user without compromising the overall stability of the wheelchair.
- Following any limit or lockout adjustments, always test the seating system over the full range of motion (i.e. tilt, recline, lifter) to verify the revised set-up is functioning properly and ensure that there are no resulting stability or interference issues.



Additional limits and lockout switches may be required for more complicated/specialised seating systems. For information on limits/lockouts that are not identified in this manual, contact your provider.

### 3.7.1 Driving Limitations

Seating systems are configured / programmed with a drive slowdown. The drive slowdown utilises microswitches to trigger the system into reduced drive speed.

All tilt and recline seating systems are equipped with a drive lockout (DLO) limit to prevent the wheelchair from being driven when the seating system is tilted or reclined beyond a pre-determined safe total angle and / or a pre-determined height. The total angle can be any combination of seat angle, backrest angle and / or surface angle.

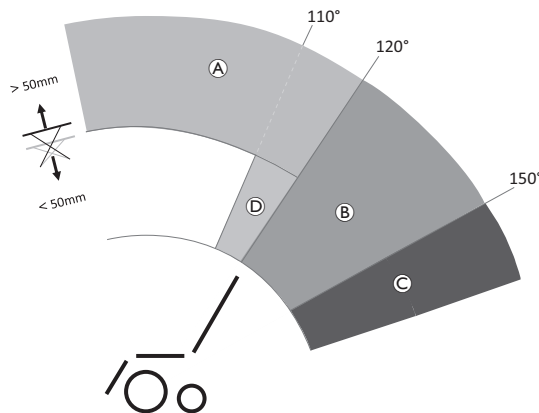

	Limitation	Cause for Limitation
Ⓐ	Drive Slowdown	If lifter / stand function is raised <ul style="list-style-type: none"> <li>• &gt;50 mm</li> </ul>
Ⓑ	Drive Slowdown / Lockout adjustable by provider	If backrest angle is <ul style="list-style-type: none"> <li>• &gt;100° – &lt;120°<sup>1</sup></li> </ul>
Ⓒ	Drive Lockout	If backrest angle is <ul style="list-style-type: none"> <li>• &gt;115° (without Drive Slowdown)</li> <li>• &gt;120° (with Drive Slowdown)</li> </ul>

<sup>1</sup> The provider can determine the angle when the drive slowdown should turn into a drive lockout.



### 3.7.2 Seating Limitations

#### Max. Back Angle Limit

The maximum back angle limits how far the backrest can be reclined using either the tilt or recline actuators. The seating systems are typically preset at the factory to the maximum allowable angle and do not require any further adjustment unless the maximum angle needs to be decreased (see hazard statement below).

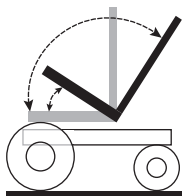

Max. Tilt Limit = 45°

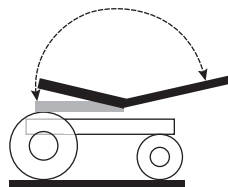

Max. Back Angle Limit = 168°



#### Risk of Damage to Wheelchair

- When establishing the maximum back limit, always consider the size and location of any personal gear that may be carried on the wheelchair, as it could cause interference between the backrest and the wheelchair base when fully tilted / reclined, and damage the actuator and / or wheelchair.

## 4 Accessories / Options

### 4.1 Posture Belts

A posture belt is an option which can either be fixed to the power wheelchair ex-works or can be retrofitted by your specialist provider. If your power wheelchair is fitted with a posture belt, your specialist provider will have informed you about fitting and usage.

The posture belt is used to help the power wheelchair user keep an optimum seating position. Correct use of the belt assists the user in sitting securely, comfortably and well-positioned in the power wheelchair, especially for such users who do not have such a good sense of balance while sitting.

 We recommend using the posture belt whenever the power wheelchair is used.

#### 4.1.1 Types of Posture Belts

You can be fitted with the following posture belt types ex-works. If your power wheelchair has been fitted with a different belt to those listed below, please ensure that you have received the manufacturer's documentation with regard to correct fitting and use.



#### **WARNING!** **Risk of Injury or Death**

Failure to utilise the MPS system safety accessories provided and / or failure to follow proper adjustment procedures can result in serious injury or death.

- Always wear postural belt when seated in the wheelchair.



- Always ensure the chest strap is properly adjusted and secured before transitioning into standing position.

#### 2-Point Padded Lap Belt



- Belt can be adjusted on both sides
- Centre-pull push button, padded lap belt
- Two points of attachment to the power wheelchair
- Suitable for supporting users with low tone or weakness

#### 4-Point Padded Lap Belt



- Belt can be adjusted on both sides
- Centre-pull push button, padded lap belt
- Four points of attachment to the power wheelchair
- Primary attachments position the belt and secondary attachments anchor it in position
- Holds pelvis in place more aggressively for active users, or in situations where the user has a lot of movement

## Chest Strap



- Belt can be adjusted on both sides
- Centre-pull push button, padded chest belt
- Two points of attachment to the backrest of the power wheelchair
- Holds upper body in place when in standing position.

### 4.1.2 Adjusting Posture Belt Correctly



The belt should be tight enough to ensure that you are sitting comfortably and that your body is in the correct sitting position.

1. Ensure that you are sitting correctly, which means that you are sitting right at back of seat, your pelvis is positioned erect and as symmetrically as possible, not to front, to side or at one edge of seat.

2. Position posture belt so that your hipbones can be easily felt above belt.
3. Adjust belt length using one of adjustment aids described above. The belt should be adjusted so that you can fit a flat hand between belt and your body.
4. Buckle should be positioned as centrally as possible. In doing so, carry out adjustments on both sides as much as possible.
5. Check your belt every week to ensure that it is still in good working condition, to ensure it has no damage or wear, and that it is fixed properly to power wheelchair. If belt is only fastened with a bolted connection, ensure that connection has not loosened or come undone. You can find more information about maintenance work on belts in the service manual, which is available from Invacare.

## 5 Setup

### 5.1 General Setup Information



#### **WARNING!**

#### **Risk of Death, Serious Injury or Damage**

Continued use of the power wheelchair that is not set to the correct specifications may cause erratic behaviour of the power wheelchair resulting in death, serious injury, or damage.

- Performance adjustments should only be made by professionals of the healthcare field or persons fully conversant with this process and the driver's capabilities.
- After the power wheelchair has been set-up / adjusted, check to make sure that the power wheelchair performs to the specifications entered during the set-up procedure. If the power wheelchair does not perform to specifications, IMMEDIATELY turn the power wheelchair Off and re-enter set-up specifications. Contact Invacare, if power wheelchair still does not perform to correct specifications.



#### **WARNING!**

#### **Risk of Death, Serious Injury or Damage**

Attaching hardware that is loosely secured or missing could cause instability resulting in death, serious personal injury, or property damage.



- After ANY adjustments, repair or service and before use, make sure that all attaching hardware is present and tightened securely.



#### **WARNING!**

#### **Risk of Injury or Damage**

Incorrect set up of this power wheelchair performed by users / caregivers or unqualified technicians can result in injury or damage.

- DO NOT attempt to set up this power wheelchair. Initial set up of this power wheelchair MUST be performed by a qualified technician.
- Adjustment by the user is only recommended after they have been given appropriate guidance by the healthcare professional.
- DO NOT attempt to carry out the work if you do not have the listed tools available.



#### **CAUTION!**

#### **Risk of Injury or Damage**

The power wheelchair is fitted with an individual, multiply adjustable seating system including adjustable legrests, armrests, a headrest or other options which are used to adapt the seat to the physical requirements and the condition of the user. It is possible that collisions or pinch points can occur between power wheelchair components due to various combinations of adjustment options and their individual settings.



When adapting the seating system and the seat functions to the user:

- Beware of pinch points when adjusting the power wheelchair components and
- ensure that no power wheelchair components collide.



**NOTICE!**

The mobility device is manufactured and configured individually to the specifications of the order. The assessment must be performed by a healthcare professional according to the user’s requirements and health conditions.

- Consult a healthcare professional if you intend to adapt the mobility device configuration.
- Any adaption should be performed by a qualified technician.



Initial setup should always be done by a healthcare professional. Adjustment by the user is only recommended after they have been given appropriate guidance by the healthcare professional.

**Electrical Adjustment Options**



Refer to the user manual for your remote for more information on operating electrical adjustment options.

**Footplates**

All footplates offered by Invacare can be folded upwards.

**5.2 Adjusting Standard Remote Holder**

**Adjusting Remote Height**



- 3 mm Allen key

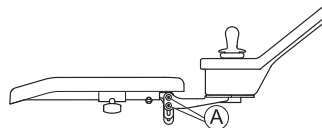

1. Loosen screws **A**.
2. Adjust component to desired position.
3. Tighten screws.

**Adjusting Remote for Length of User's Arm**

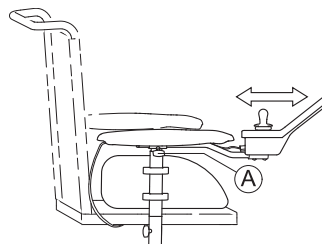

1. Loosen wing screw **A**.
2. Adjust component to desired position.
3. Tighten wing screw.

### 5.3 Adjusting Swing Away Remote Holder

The following information is valid for all seating systems.



#### CAUTION!

**Risk of the remote being pushed backwards during an accidental collision with an obstacle, such as a doorframe or table, and the joystick being jammed against the armpad if the position of the remote is adjusted and all screws are not completely tightened**

This will cause the power wheelchair to drive forward uncontrollably and potentially injure the power wheelchair user and any person standing in the way.

- When adjusting the position of the remote, always make sure to tighten all screws securely.
- If this should accidentally happen, immediately switch the power wheelchair electronics OFF at the remote.



#### CAUTION!

#### Risk of Injury

When leaning on the remote, for example, when transferring into or out of the wheelchair, the remote holder may break and the user may fall out of the chair.

- Never lean on the remote as a support for, for example, transfer.

### Adjusting Remote Height



- 6 mm Allen key

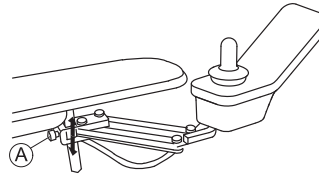

1. Loosen screw **A**.
2. Adjust component to desired position.
3. Tighten screw.

### Adjusting Remote Offset

The remote can be adjusted by 20 mm sidewise.



- 3 mm Allen key

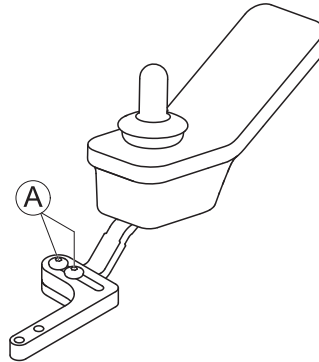

1. Loosen screws **A**.
2. Adjust component to desired position.
3. Tighten screws.

## 5.4 Adjusting Quad Link Remote Holder

### Adjusting Remote Height



- 6 mm Allen key

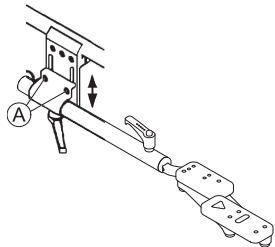

1. Loosen the two set screws **A** on the remote mount.
2. Push or pull the remote mounting tube up or down to the desired height.
3. Tighten the two set screws on the remote mount.

### Adjusting Remote Position



- 6 mm Allen key

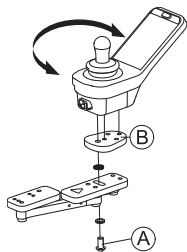

1. Loosen screw **A** securing adjustable remote tray **B** to Quad Link.
2. Rotate remote to desired position.
3. Tighten screw to secure adjustable remote tray to Quad Link.

## Adjusting Lock Tension

By default, the Quad Link is fitted with two magnets locking the Quad Link in extended position. Removing a magnet reduces the tension and makes it easier to release the Quad Link.



### CAUTION!

#### Risk of Injury or Damage to Wheelchair

Removing both magnets leaves Quad Link without lock. Quad Link could retract unintentionally.  
— Always leave at least one magnet.



- Small pointed tool such as paper clip

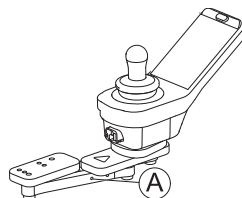

1. Swivel Quad Link to side to access magnets.
2. Insert tool in hole **A** and push out magnet on other side.

## 5.5 Adjusting Maxx Resolve Swing-Away Remote Holder

### Adjusting Remote Depth



The depth adjustment on an offset remote tube is the same as for a straight remote tube.



- 5 mm Allen key

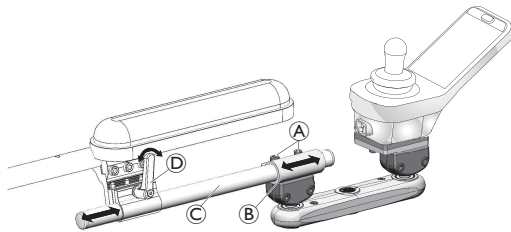

1. Loosen screws **A** to adjust clamp **B** on tube **C** to desired depth of remote.  
Tighten screws when desired position is reached.
- and / or
2. Loosen lever **D** to adjust tube **C** to desired depth of remote.  
Tighten lever when desired position is reached.

### Offset Remote Tube Configurations

By rotating the offset remote tube, the direction of the offset can be adjusted to several configurations:

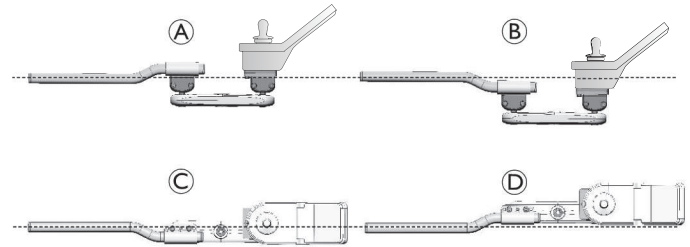

- A** raised
- B** lowered
- C** outward (if mounted on right armrest) / inward (if mounted on left armrest)
- D** inward (if mounted on right armrest) / outward (if mounted on left armrest)

### Height and Angle Adjustment

The height / angle of the Maxx Resolve Remote Holder is adjusted via two ball clamp assemblies on the swing away mechanism. The rear ball clamp assembly is attached to the remote tube, on the front ball clamp assembly the remote is mounted. Both ball clamp assemblies can be independently adjusted to position the remote at the height and / or angle that fits the user's needs.





Ball clamp assemblies mounted upwards



Ball clamp assemblies mounted downwards



 When adjusting the angle of the ball clamp assemblies upwards, the body of the swing away mechanism becomes angled upward. This upward angle means that when the remote swings outward (when mounted on the right armrest) or inward (when mounted on the left armrest), it will swing-away to a lower position. The opposite effect applies when the angle of the ball clamp assemblies is adjusted downwards.

 • 5mm Allen key

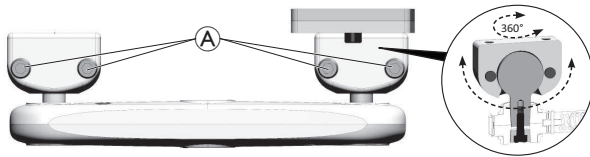

Angle Adjustment

Height Adjustment

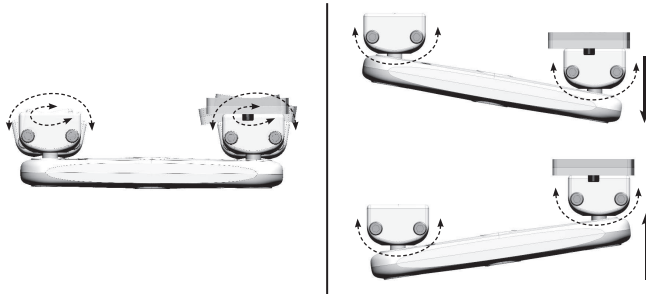

1. Loosen screws **A** in each ball clamp assembly.
2. Pivot / Rotate the ball clamp assemblies to desired angle / height.
3. Tighten screws, when desired position is reached.

## Break-Away Tension Setting Adjustment

The Maxx Resolve Swing-Away Remote Holder uses a tension adjustable belt-drive to control the “break-away” force required to reposition the remote. The tension can be adjusted via the cam wheel at the centre of the swing-away mechanism. There are four tension setting options available to accommodate the user’s strength and mobility. The break-away tension should be set to fit the user’s needs.

 • 6 mm Allen key

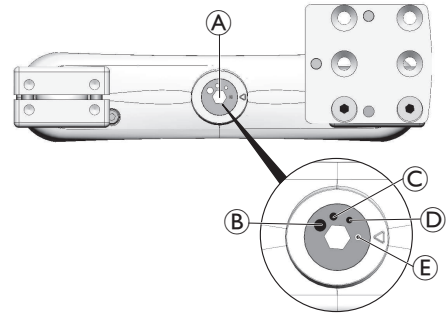

1. Use the cam wheel **A** to adjust the break-away tension to one of the four setting options:
  - B** hard
  - C** medium
  - D** easy
  - E** very easy

## 5.6 Adjusting Nucleus Midline Holder



### WARNING!

#### Risk of Injury or Damage

Loose small parts can lead to choking hazard that may result in injury or death.

- Do not remove any small parts except to replace the joystick knob.
- Do not leave removed joystick knob unattended.
- Closely supervise children, pets or people with physical / mental disabilities.



### CAUTION!

#### Risk of Injury or Damage

Remaining burrs and missing end caps after modifications on rods, such as shortened rod, can lead to injury or damage.

- Deburr cut after cutting excessive length.
- Re-install end cap after deburring.
- Check end cap for tight fitting.

### 5.6.1 Adjusting Depth of Nucleus Midline Holder

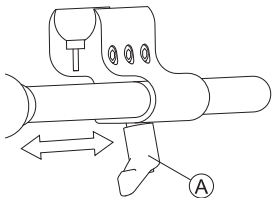

1. Loosen lever (A).
2. Shift nucleus midline holder to desired position.
3. Tighten lever.

### 5.6.2 Adjusting Height of Nucleus Midline Holder

You can adjust the height of the nucleus midline holder in two ways:

- Adjust it together with the armrest height. Refer to corresponding armrest chapters.
- Adjust the height of the nucleus midline holder only. Refer to section below.



- 3/16 inch Allen key

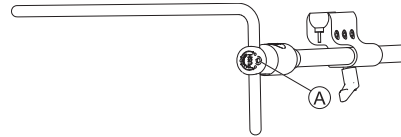

1. Loosen screw (A).
2. Adjust nucleus to desired height.
3. Tighten screw.

### 5.6.3 Adjusting Remote / Display Position



- 4 mm Allen key
- 8 mm wrench

#### Tilting Remote (DLX-REM110, DLX-REM2XX, DLX-REM400)

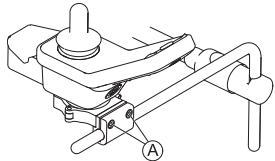

1. Loosen screws (A).
2. Position remote on holder.
3. Tighten screws.

Fig. 5-1 Example of DLX-REM400 adjustment. DLX-REM110, DLX-REM211 and DLX-REM216 are adjusted the same way.

#### Rotating Remote (DLX-REM110, DLX-REM2XX, DLX-REM400)

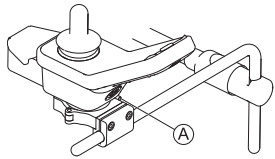

1. Loosen screw (A).
2. Rotate remote in clamp to desired position.
3. Tighten screw.

Fig. 5-2 Example of DLX-REM400 adjustment. DLX-REM110, DLX-REM211 and DLX-REM216 are adjusted the same way.

#### Tilting Remote (DLX-CR400 and DLX-CR400LF)

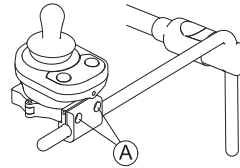

1. Loosen screws (A).
2. Position remote on holder.
3. Tighten screws.

#### Rotating Remote (DLX-CR400 and DLX-CR400LF)

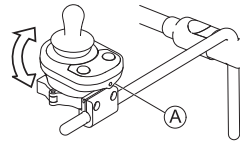

1. Loosen screw (A) (not shown in picture).
2. Rotate remote in clamp to desired position.
3. Tighten screw.

#### DLX-REM500



- 3/16 inch (5 mm) Allen key

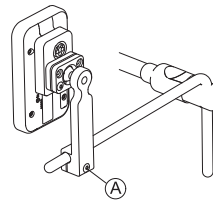

1. Loosen screw (A).
2. Position display on holder.
3. Tighten screw.

## ASL Components on Nucleus Tray



- 3/16 inch (5 mm) Allen key

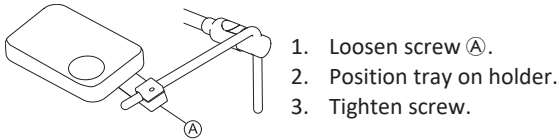

1. Loosen screw (A).
2. Position tray on holder.
3. Tighten screw.

Fig. 5-3 Graphic serves as an example.

## ASL Components on Nucleus Midline Holder Only



- 5/32 inch (4 mm) Allen key

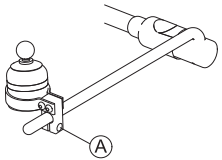

1. Loosen screw (A).
2. Position ASL component on holder.
3. Tighten screw.

Fig. 5-4 Graphic serves as an example.

## 5.7 Adjusting Swing-Away Mechanism



### WARNING!

#### Risk of Injury or Damage

Loose small parts can lead to choking hazard that may result in injury or death.

- Do not remove any small parts except to replace the joystick knob.
- Do not leave removed joystick knob unattended.
- Closely supervise children, pets or people with physical / mental disabilities.



### CAUTION!

#### Risk of Injury or Damage

Remaining burrs and missing end caps after modifications on rods, such as shortened rod, can lead to injury or damage.

- Deburr cut after cutting excessive length.
- Re-install end cap after deburring.
- Check end cap for tight fitting.

The swing-away mechanism can be used for different options such as:

- PROTON wings of head array
- Extremity control joystick for chin control
- Egg switch



- 5/32 inch (4 mm) Allen key

### Adjusting Depth

1. Loosen screw (A).
2. Adjust rod to desired depth.
3. Tighten screw.

### Adjusting Position

The swing-away mechanism can be turned through 360 degrees.

4. Loosen screw (A).
5. Adjust to desired position.
6. Tighten screw.

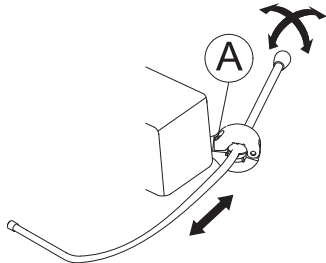

## 5.8 Adjusting Swing-Away Display Holder



- 3 mm Allen key

### Adjusting Holder Height

1. Loosen screws (A).
2. Position holder to desired height.
3. Tighten screws.

### Adjusting Holder Orientation

The holder can be turned through 360 degrees.

1. Loosen screws (A).
2. Adjust holder orientation.
3. Tighten screws.

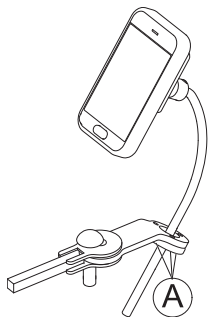

## Adjusting Display Orientation

The display can be turned through 360 degrees.



- 18 mm wrench



1. Loosen clamping bush (A).
2. Adjust display orientation.
3. Tighten clamping bush.

## 5.9 Adjusting Manual Chin Control



### WARNING! Risk of Injury or Damage

Loose small parts can lead to choking hazard that may result in injury or death.

- Do not remove any small parts except to replace the joystick knob.
- Do not leave removed joystick knob unattended.
- Closely supervise children, pets or people with physical / mental disabilities.

**CAUTION!****Risk of Injury or Damage**

Remaining burrs and missing end caps after modifications on rods, such as shortened rod, can lead to injury or damage.

- Deburr cut after cutting excessive length.
- Re-install end cap after deburring.
- Check end cap for tight fitting.

**5.9.1 Adjusting Extremity Control Joystick****Adjusting Joystick Orientation**

The joystick can be turned through 360 degrees. A slot on the side allows you to angle the joystick at 90 degrees.

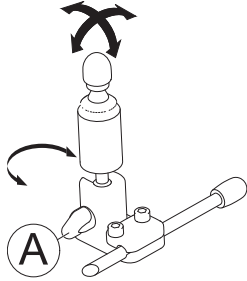

1. Loosen hand screw (A).
2. Turn underpart of joystick to position slot.
3. Adjust joystick orientation. If desired, lock joystick in 90 degree angle in slot.
4. Tighten hand screw.

**Adjusting Position on Holder**

- 5/32 inch (4 mm) Allen key

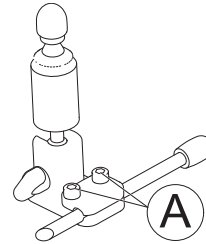

1. Loosen screws (A).
2. Position joystick on holder.
3. Tighten screws.

**Adjusting Depth and Height**

Refer to 5.7 *Adjusting Swing-Away Mechanism*, page 44.

**5.9.2 Adjusting Egg Switch****Adjusting Switch Orientation**

The egg switch can be turned through 360 degrees.



- 7/16 inch(11 mm) wrench

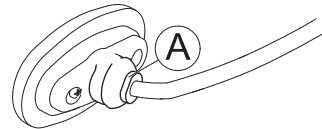

1. Loosen nut (A).
2. Adjust egg switch orientation.
3. Tighten nut.

**Adjusting Depth and Height**

Refer to 5.7 *Adjusting Swing-Away Mechanism*, page 44.

## 5.10 Adjusting Head Array

### Adjusting Pad Position



- 5/32 inch (4 mm) Allen key

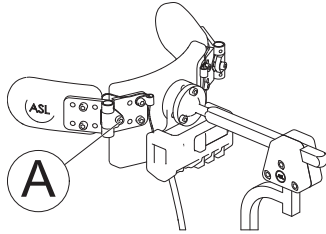

1. Loosen screw **A**.
2. Adjust pad position.
3. Tighten screw.

### Adjusting PROTON Wings

Refer to 5.7 *Adjusting Swing-Away Mechanism*, page 44.

### Adjusting Headrest Position

Refer to 5.15.3 *Adjusting Multi-axis Headrest Hardware*, page 55.

## 5.11 Adjusting Sip and Puff Head Array

### Adjusting Pad Position



- 5/32 inch (4 mm) Allen key

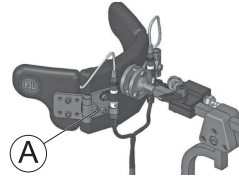

1. Loosen screw **A**.
2. Adjust pad position.
3. Tighten screw.

### Adjusting Position of Sip and Puff Tube

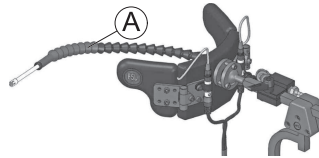

1. Bend flexible sip and puff tube **A** to desired position.

### Adjusting Depth of Sip and Puff Tube

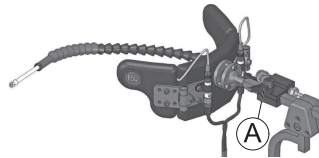

1. Loosen clamping lever **A**.
2. Adjust sip and puff tube to desired depth.
3. Tighten clamping lever.

### Adjusting Headrest Position

Refer to 5.15.3 *Adjusting Multi-axis Headrest Hardware*, page 55.

## 5.12 Adjusting Cantilever Flip-up Armrest

### Adjust Armrest Height



- 13 mm wrench

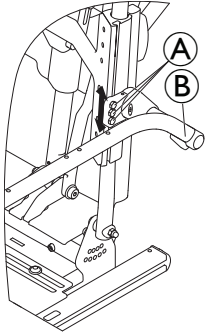

1. Loosen screws **A**.
2. Adjust armrest **B** to desired height.
3. Tighten screws.

### Adjusting Armrest Angle



- 4 mm Allen key

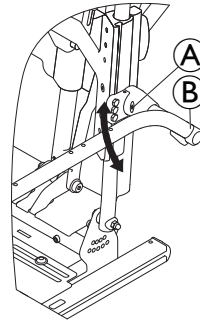

1. Loosen set screw **A**.
2. Adjust angle of armrest **B** by moving up or down.
3. Tighten set screw.

### Replacing Armrest

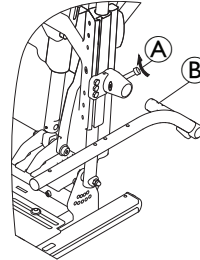

1. Pull plunger pin **A**.
2. Rotate plunger pin 1/4 - 1/2 turns to remain unlocked.
3. Pull armrest **B** out of mounting bracket.
4. Install parts in reverse order. Make sure, that plunger pin is fully engaged.



## 5.12.1 Arm Pad Installation / Adjustment



- 4 mm Allen key

### Arm Pad Orientation

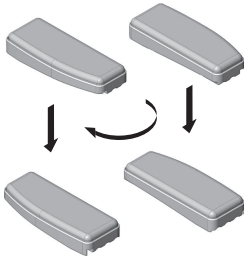

You can switch the arm pad orientation from taper forward to taper rearward.

### Arm Pad Body Installation



1. Using hardware provided, install moulded arm pad body onto armrest tube in pre-determined mounting orientation (see above) and arm pad position (see width and depth adjustments below).

## Arm Pad Installation



- Phillips screwdriver



1. Secure modular arm pad inside moulded arm pad body via hook-and-loop straps (not shown).
2. If wheelchair is to be used as vehicle seat, additionally secure arm pad with screws.

### Width Adjustment



Centre and inside mount positions may limit how far the armrest will flip/rotate backward during side transfers.

Fig. 5-5 Outside mount

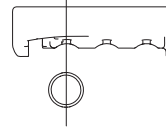

Fig. 5-6 Centre mount

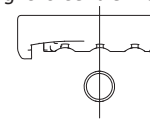
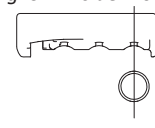
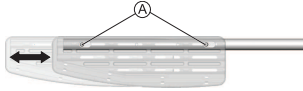

Fig. 5-7 Inside mount



## Depth Adjustment

You can adjust the arm pad depth by 1.75 inch (45 mm).



1. Loosen mounting screws (A).
2. Adjust arm pad to desired position.
3. Re-tighten screws.

## 5.13 Adjusting Hip Support with Quick Release

### Adjusting Position



- 5 mm Allen key

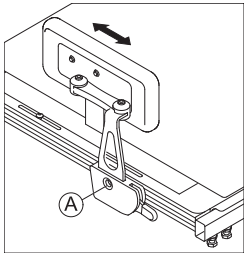



1. Loosen screw (A).  
Do not remove it.
2. Adjust hip support to desired position.
3. Tighten screw.

## Adjusting Width

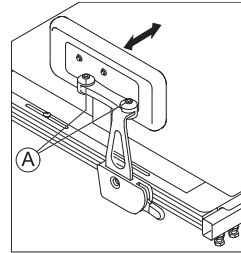

- 2 x 5 mm Allen key



1. Loosen screws (A).
2. Adjust hip support to desired width.  
 You can adjust the width only smaller than the seat width but not wider.
3. Tighten screws.

## Adjusting Angle



- 5 mm Allen key

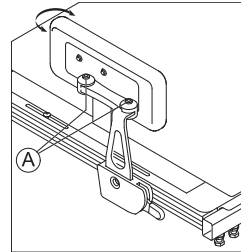

1. Loosen screws (A).
2. Adjust hip support to desired angle.
3. Tighten screws.

## Adjusting Hip Pad Depth



- 10 mm wrench

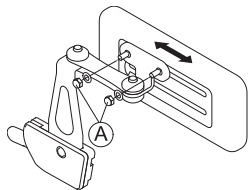

1. Loosen the two screws **A**.
2. Adjust hip pad to desired depth.
3. Tighten screws.

## Adjusting Hip Pad Height

You can adjust the hip pad height in two ways:

- Via its mounting slots.
- Via its bracket.

### Via mounting slots



- 10 mm wrench

1.

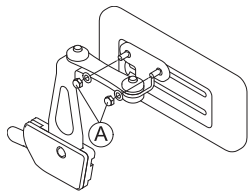

Loosen the two screws **A**.

2.

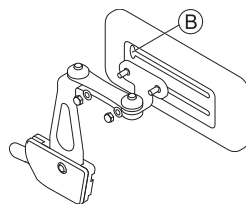

Remove hip pad bracket from mounting slot via cut-out **B**.

3. Insert hip pad bracket in other mounting slot.

4. Tighten screws.

### Via bracket



- 5 mm Allen key

1.

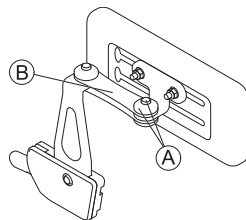

Remove upper screw and friction cap **A**.

2. Remove small friction link **B**.

3.

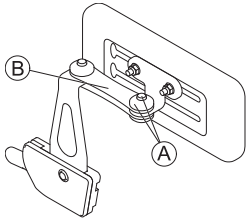

Remove hip pad with bracket, turn upside down and reinstall.

4. Insert friction link, friction cap, screw and tighten.

## 5.14 Adjusting Lateral Trunk Support



- 4 mm Allen key
- 10 mm wrench

### Swing-away Feature

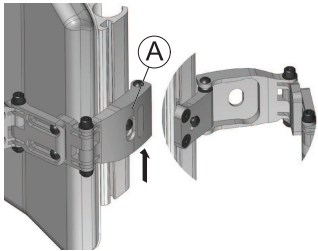

1. Lift bracket **A** up to release.
2. Swing lateral rearward.

### Adjusting Angle

The angle can be adjusted infinitely.

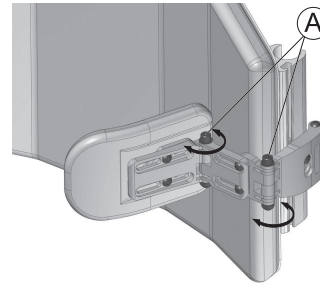

1. Loosen nuts / screws (x2) **A** to adjust pad angle.

### Adjusting Width

When adjusting both laterals, the width can be adjusted to total of 89 mm (3.5").

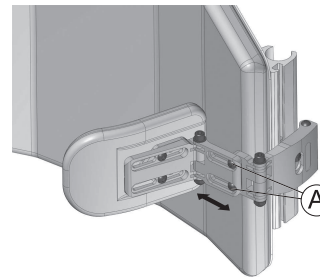

1. Loosen screws (x2) **A** to adjust bracket width.

## Adjusting Pad Depth

The pad depth can be adjusted in a range of 63.5 mm (2.5") in total.

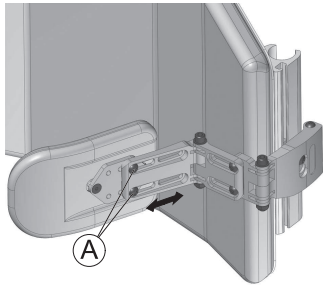

1. Loosen screws (x2) **A** to adjust pad depth.

## Adjusting Height

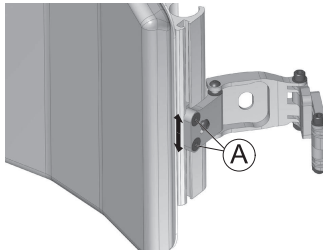

1. Loosen screws (x2) **A** to adjust lateral height (or remove).

## 5.15 Adjusting the Headrest

The headrest clamp hardware is designed to install into existing mounting holes in the backrest pan.



### CAUTION!

**Risk of injury during use of the power wheelchair as a vehicle seat if a headrest is wrongly adjusted or not installed**

This can cause the neck to be hyperextended during collisions.

- A headrest must be installed. The headrest optionally supplied for this power wheelchair by Invacare is perfectly suitable for use during transport.
- The headrest must be adjusted to the user's ear height.

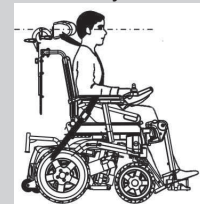

### NOTICE!

- For systems equipped with power recline and ESR, always inspect / test the headrest (down tube) for possible interference over the full range of recline. If interference occurs, the length of the down tube must be modified as necessary.



- It may be necessary to remove and modify the back cushion cover in order to access the headrest mounting holes on the back pan.
- An optional shim plate is available. It may be installed between the clamp assembly and the back pan to provide additional spacing / clearance on Posture Back and Deep Back.

### 5.15.1 Auto-style Headrest Set-up and Installation



- 2.5 mm Allen key
- 4 mm Allen key
- 5 mm Allen key
- 10 mm wrench

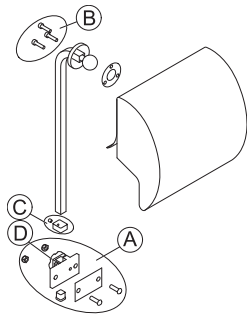

1. Using the hardware provided, align and install the headrest clamp assembly into the existing mounting holes in the back pan (A).
2. Secure the headrest pad to the headrest rod via the mounting hardware provided (B).



The headrest pad can be adjusted to any desired angle via the pivot ball at the end of the headrest rod by loosening and tightening the mounting hardware.

3. Adjust the overall height of the headrest pad / mounting post

via the knob (D).

For proper set-up the headrest should be adjusted to the user's ear height.

4. Once the final height position is set, adjust the D-Ring (with set-screw) so that it rests flush with the top of the clamp assembly (to prevent slipping) (C).

### 5.15.2 Adjusting Elan Headrest Hardware

Elan headrest hardware is highly adjustable. The illustration below shows the possible adjustment ranges of the joints.

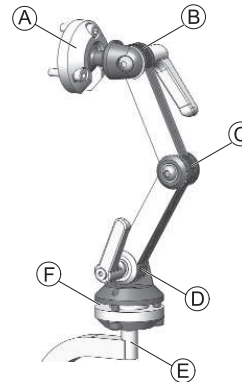



(A)	Upper multi-angle rotational pivot	<ul style="list-style-type: none"> <li>• 360° rotation</li> <li>• 80° tilt</li> </ul>
(B)	Upper linkage	<ul style="list-style-type: none"> <li>• 180° rotation</li> </ul>
(C)	Middle linkage	<ul style="list-style-type: none"> <li>• 100° rotation</li> </ul>
(D)	Lower linkage	<ul style="list-style-type: none"> <li>• 180° rotation</li> </ul>
(E)	Mounting post	<ul style="list-style-type: none"> <li>• 360° rotation in 90° increments</li> </ul>
(F)	Lower multi-angle rotational pivot	<ul style="list-style-type: none"> <li>• 360° rotation</li> <li>• 50° tilt</li> </ul>

## Installing

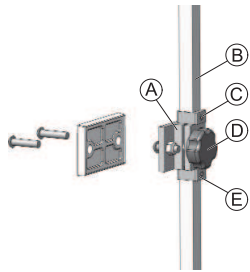

- 2.5 mm Allen key
- 4 mm Allen key
- 5 mm Allen key



1. Using hardware provided, align and install headrest clamp assembly into existing mounting holes in backrest pan (A).
2. Install headrest pad (not shown) to headrest rod using mounting hardware provided.
  -  The headrest pad can be adjusted to any desired angle via the pivot ball at the end of the headrest rod by loosening and tightening the mounting hardware.
3. Loosen and remove lower D-Ring (E) from hardware.
4. Slide vertical mounting post (B) into clamp assembly and adjust overall height of headrest pad to desired position. Tighten knob (D). For proper set-up headrest should be adjusted to user's ear height.
5. Adjust upper D-Ring (C) as required.
6. Once final height position is set, adjust lower D-Ring (E) so that it rests flush with bottom of clamp assembly (to prevent slipping).

## Adjusting Depth and Angle

The headrest can be further adjusted for depth and angle via the articulating hardware.



- 4 mm Allen key
- 5 mm Allen key

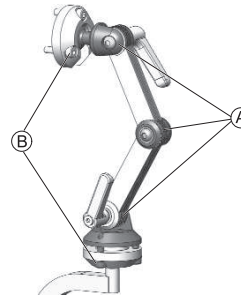

1. Loosen screws and clamping levers of dual link adjustment assembly (A) and screws of upper and lower rotational pivots (B).
2. Adjust component to desired position.
3. Tighten screws and clamping levers.

### 5.15.3 Adjusting Multi-axis Headrest Hardware

#### Installing



The headrest pad can be adjusted to any desired angle via the pivot ball at the end of the headrest rod by loosening and tightening the mounting hardware.



- 2.5 mm Allen key
- 4 mm Allen key
- 10 mm wrench

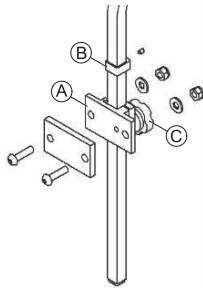

1. Using hardware provided, align and install headrest clamp assembly into existing mounting holes in backrest pan (A).
2. Install headrest pad (not shown) to headrest rod using mounting hardware provided.
3. Adjust overall height of headrest pad to desired position. Tighten knob (C). For proper set-up headrest should be adjusted to user's ear height.

3. Once final height position is set, adjust D-Ring (B) so that it rests flush with top of clamp assembly (to prevent slipping).

### Adjusting Depth and Angle

The headrest and horizontal rod can be further adjusted for depth and angle via the triangular multi-offset bracket.



- 5/32 inch (4 mm) Allen key

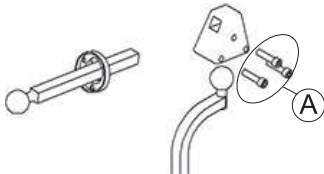

1. Loosen hardware in multi-offset bracket (A).
2. Adjust headrest to desired position.
3. Re-tighten hardware.

## 5.16 Adjusting the Height of the Backrest



- 4 mm Allen key

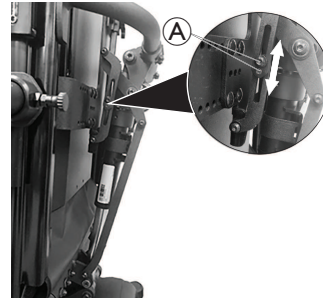

1. Loosen screws (A) and slide the linkage up or down to the desired position.
2. Tighten the screws.

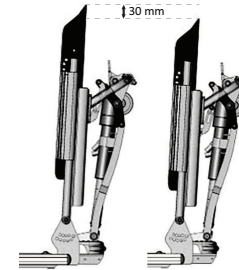

The height can be adjusted around 30 mm.



## 5.17 Adjusting the Chest Bar



### WARNING!

#### Risk of Injury or Death

Failure to utilise the MPS system safety accessories provided and/or failure to follow proper adjustment procedures can result in serious injury or death.

- Always ensure the chest bar is properly adjusted and locked into position before transitioning into standing position.

### 5.17.1 Adjusting Chest Bar Height



- 3 mm Allen key



1. Loosen the set screw **A** on both sides of the chest bar.
2. Adjust chest bar equally along the posts to desired height.
3. Tighten set screws on both sides of the chest bar.

### 5.17.2 Adjusting Chest Bar Depth



- 4 mm Allen key



1. Loosen screws **A** on left and right armrest.
2. Slide chest bar for- or backwards until desired position.
3. Tighten screws on left and right armrest.

## 5.18 Adjusting Legrest

### 5.18.1 Adjust the Height of the Footrest



### WARNING!

#### Risk of Injury or Damage

Operating the power wheelchair with insufficient ground clearance between the footrests and the floor may cause injury or damage.

- While the power wheelchair is in motion, ALWAYS maintain a minimum ground clearance of 76 mm or the minimum ground clearance stated in the technical data.
- If necessary, elevate the front rigging or tilt the seat to achieve the proper ground clearance prior to driving the power wheelchair.



— If the power wheelchair dips forward and the footrests touch the ground while in motion, please contact your Invacare distributor for immediate assistance and / or inspection. Do not use the power wheelchair until corrected.

With the user in a seated upright (non-standing) position, the height of the footrests should be adjusted to optimise the comfort and position of the users legs.

The height of the footrests are adjusted via the mounting positions of the footrest mounting brackets on the legrest extension tube. There are two types of mounting brackets available, depending on the desired height of the footrests.



- 8 mm Allen key

Inverted brackets with  
available height: 203 - 305  
mm

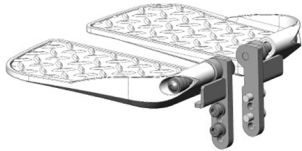

Standard brackets with  
available height: 280 - 430  
mm

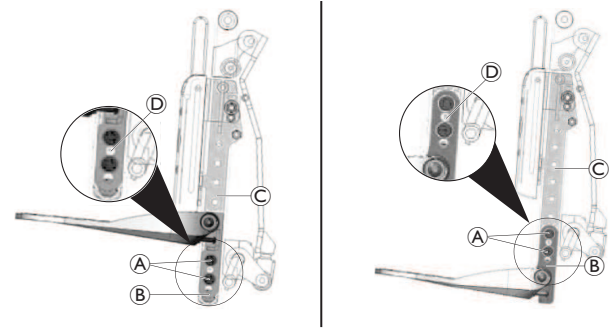
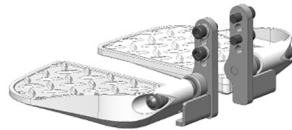

1. Loosen/remove the adjustment screws **A** of the footrest mounting bracket **B**.
2. Adjust the footrest to the desired height on the extension tube **C** and fasten adjustment screws of the footrest mounting bracket.



Maintain one hole spacing **D** between the adjustment screws.

The two highest adjustment holes cannot be used to fasten the inverted mounting brackets.

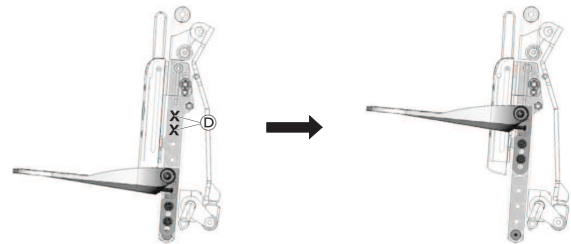

### 5.18.2 Adjust the Width of the Footrests



- 5 mm Allen key



2. Depending on the desired width of the footrest, add the spacers like shown in the table below.

Narrow	Medium narrow	Medium
Medium wide	Wide	



### 5.18.3 Setting Height and Width of Calf Pad



#### Risk of damage to the power wheelchair

- After changing the configuration of the calf pads make sure that the calf pads contact neither the castors nor the seat plate when adjusting the legrest angle.

Calf pads may be adjusted independently on their respective mounting bracket using the mounting screws at the rear of the calf pads. Calf pads may be adjusted (for depth, height & angle) to achieve a variety of different configurations. The independent pad adjustments provide optimal positioning and comfort for end users - sample configurations are illustrated below.

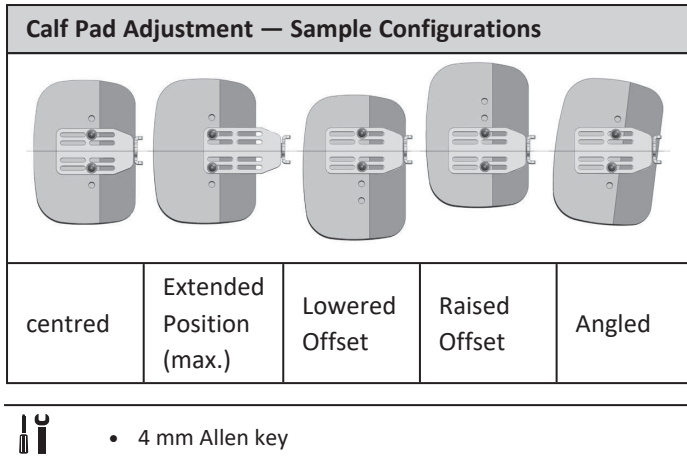

1. Fold the calf pad forward in order to access the bolts.
2. Loosen the bolts and remove them if necessary.
3. Adjust the calf pad to the required height and width.
4. Re-tighten the bolts.
5. Fold the calf pad back.

## 5.19 Installing the Knee Bolster Assembly



### **WARNING!** Risk of Injury

The set up and adjustment of the knee bolster assembly and the legrest are critical to ensure that proper ergonomics and overall comfort are maintained when the system transitions into the full standing position. Failure to ensure that both components are set-up properly may result in serious injury.

- Multiple fine tuning adjustments may be necessary to achieve the best set up for the user.



### **NOTICE!**

- While some basic adjustments may be performed by the user or attendant, to ensure the knee bolster and / or legrest is adjusted safely and properly, always consult your healthcare professional prior to performing any adjustments.



### **NOTICE!**

- BEFORE installing and adjusting the knee bolster, ensure the seat depth and knee-to-heel length of the legrest are properly adjusted to fit the user. The final set up of the knee bolster may vary from one user to the next. The following instructions/ recommendations are provided as a guideline to illustrate the various adjustment options. The Stander System (including the knee bolster)

! should always be adjusted to best meet the needs of the user, and the final set up should be based on the clinical judgement / expertise of the healthcare professional.

! **NOTICE!**  
 — The knee bolster is designed to provide lower leg stability and support in the full standing position. The knee block **MUST** be installed **PRIOR** to transitioning the wheelchair into the standing position. Proper set-up / adjustment of the knee bolster assembly is **EXTREMELY** important to prevent injury and ensure user safety and stability when standing. It is strongly recommended to practice / rehearse transitioning in and out of the standing position in the presence healthcare professional prior to first use.

i To begin the knee bolster set up, the user should be seated in the wheelchair with their hips/upper torso positioned as far back as possible in the seat, and their knees/legs comfortably positioned in line with their hips.



- 4 mm Allen key

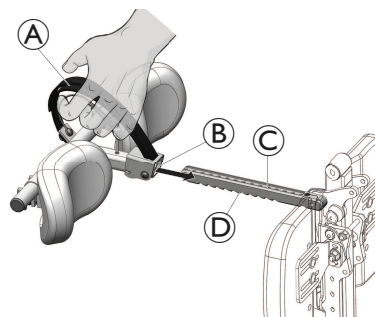

1. Hold the knee bolster assembly by the hand strap **A** and slide the ratchet mechanism **B** onto the mounting bar **C** until the desired position.

2. Release the hand strap to engage the ratchet mechanism in place.



When installing the knee bolster assembly, the ratchet mechanism engages into the angle teeth **D** of the mounting bar.

### Removing the Knee Bolster Assembly

1. Pull the hand strap up and forward to disengage the ratchet mechanism and slide the knee bolster assembly off the mounting bar.

### 5.19.1 Adjusting the Knee Bolster Assembly

Depth adjustments are available in 13 mm increments.

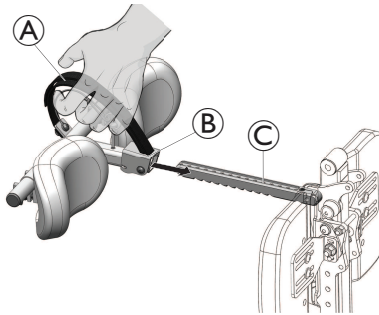

1. Take the knee bolster assembly by the hand strap **A** and slide the knee bolster assembly **B** back or forth over the mounting bar **C** until the desired position.

2. Set the initial knee pad depth until there is a visible gap of around 26 – 51 mm, or a palm width, between the knee pads and the users legs.



This gap shrinks and the knee pads press up against the users legs for support as the system transitions into the full stand position.

3. Release the hand strap to lock the knee bolster assembly in place.

4. Inspect the knee pad position relative to the users knees to determine if additional knee pad adjustments are necessary.



Knee pad adjustments can be made at anytime (as necessary) during the fitting of the knee bolster assembly. It is recommended to begin with the knee pads centred horizontally in relation to the users legs, and positioned approximately 26 mm below the tibial tuberosity **D** on the users leg.



- 5.



The overall knee pad height can be adjusted in two ways:

- by adjusting the height of the mounting bar or
- by changing the orientation of the knee pad mounting hardware.

### Adjusting the Height of the Mounting Bar



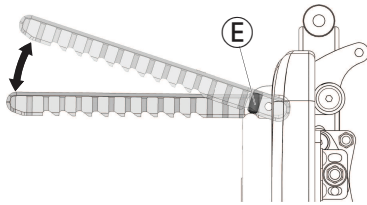

- 4 mm Allen key



Loosen or tighten the set screw **E** to change the angle of the mounting bar and thereby adjusting the height of the knee bolster assembly to the desired position.

### 6. Changing the Orientation of the Knee Pads

Standard Pad Configuration	
	
+ 19 mm relative to crossbar	- 19 mm relative to crossbar

Loosen the wing screws on the clamp assembly **F** and remove knee pad and clamp from crossbar **G**.



7. Rotate pad and clamp 180° and put back on crossbar.



This changes the knee pad height around +/- 19 mm relative to the crossbar.

8. Tighten wing screws.

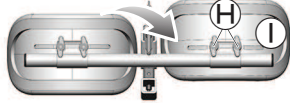
- 9.

Offset Pad Configuration	
	
+ 38 mm relative to crossbar	- 38 mm relative to crossbar

Loosen wing screws **H** and rotate the knee pad **I** 180°.

10. Tighten wing screws.

11. Remove knee pad and clamp from crossbar and rotate knee pad and clamp 180°.



This changes the knee pad height around +/- 38 mm relative to the crossbar.

- 12.

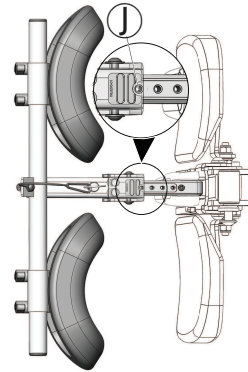

Once the desired position of the knee bolster assembly is determined, locate the first visible mounting hole **J** in the mounting bar (closest to the self-locking ratchet mechanism).

13. Remove the knee bolster assembly, refer to 5.19 *Installing the Knee Bolster Assembly*, page 60.

14.

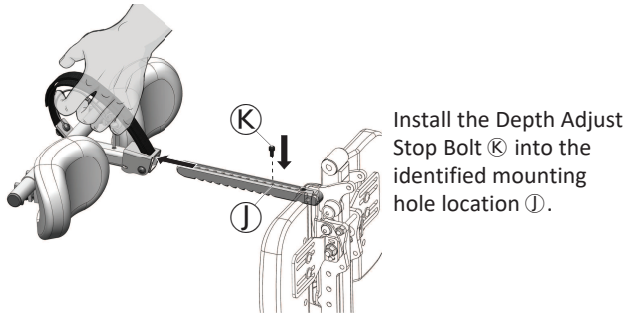

15.

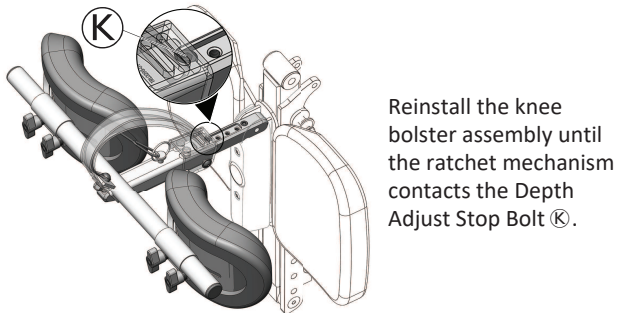

16. Verify that the ratchet mechanism is properly engaged.

 The ratchet mechanism has a red warning label (L) which should be NOT visible, if the knee bolster assembly is properly locked into place.

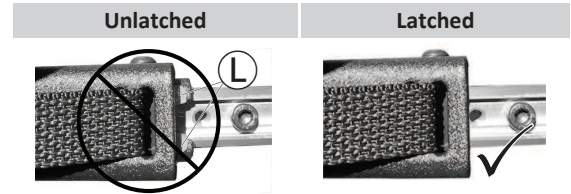

17.



**WARNING!**  
**Risk of Serious Injury!**

- The knee bolster safety pin must ALWAYS be installed PRIOR to using the stand function.

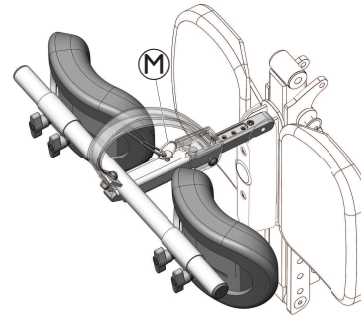

With the knee bolster assembly locked into position, insert the safety pin (M) through the knee bolster assembly and into the mounting bar.

18. Ensure the safety pin is fully engaged.



### 5.19.2 Adjusting Knee Pad Width

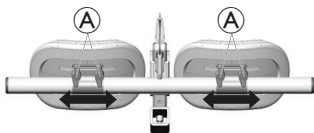

1. Loosen the wing screws (A) and slide the knee pads inwards or outwards to the desired position on the crossbar.
2. Tighten wing screws.

### 5.19.3 Adjusting Knee Pad Angle

1.

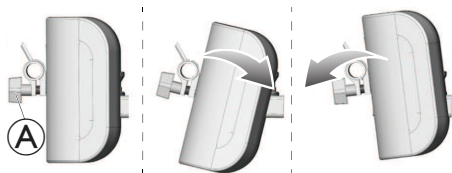

Loosen wing screws (A) and rotate the knee pad around the crossbar until the desired position.

2. Tighten wing screws.

### 5.19.4 Adjusting Eccentric Knee Pad Position

The knee pads can be independently rotated (along the horizontally axis) to produce an eccentric pad adjustment, via the curved adjustment slot at the rear of the knee pads.

1.



Loosen wing screws (A).

2.

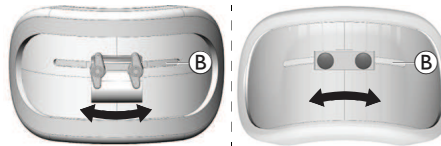

Slide knee pads inwards or outwards on the adjustment slot (B) to the desired position.



3. Tighten wing screws.

## 6 Usage

### 6.1 Driving



The maximum load capacity that is stated in the technical data only states that the system is designed for this mass in total. However, this does not mean that one can sit a person with this body weight in the power wheelchair without restrictions. Attention must be paid to the body proportions, such as height, weight distribution, abdominal belt, leg and calf strap and seat depth. These factors have a strong influence on driving features such as tilt stability and traction. The permissible axle loads in particular must be adhered to (refer to *11.1 Technical Specifications, page 96*). It may possibly be necessary to carry out adaptations to the seat system.

### 6.2 Before Driving for First Time

Before you take your first trip, you should familiarise yourself well with the operation of the power wheelchair and with all operating elements. Take your time to test all functions and driving modes.



If installed, make sure to properly adjust and use the posture belt each time you use the power wheelchair.

**Sitting comfortably = Driving safely**

Before each trip, make sure that:

- You are within easy reach of all operating controls.
- The battery charge is sufficient for the distance you intend to travel.
- The posture belt (if installed) is in perfect order.
- The rear mirror (if installed) is adjusted so you can look behind at all times without having to bend forward or shift your seating position.

### 6.3 Parking and Stationary

When parking your power wheelchair or if your power wheelchair is stationary for a prolonged period:

1. Switch the power wheelchair's power system off (ON-/OFF key).

### 6.4 Getting in and out of Power Wheelchair



#### NOTICE!

- The armrest must be removed or swiveled up in order to get into or out of the power wheelchair from the side.

#### 6.4.1 Swivelling Remote to Side

If your power wheelchair is fitted with a swivelling remote holder, then the remote can be moved away to the side, for example, to drive up close to a table.

## Swing-Away Remote Holder

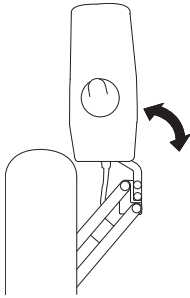

1. Push remote to swivel remote holder to the side.

## Quad Link Remote Holder



### WARNING!

#### Risk of Pinch Points

- Make sure fingers are not between the linkage bars when locking the Quad Link retractable remote mount into position. Pinch points will occur between the linkage bars when locking the Quad Link into position.

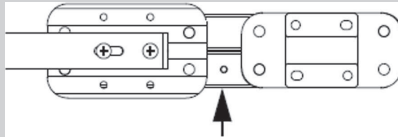

## Swivel Remote to Side

- 1.



To retract remote from normal extended position, push outward on inside surface of remote until Quad Link is free.



The Quad Link works the best when the remote is pushed outward on the inside surface of the remote, near the armrest pad.

2. Push remote outward and rearward until Quad Link moves through its complete range into its fully retracted position.

## Return Remote to Extended Position

- 1.

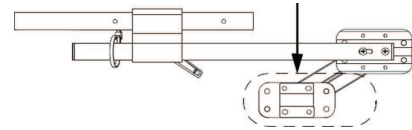

To return remote to normal extended position, push outward on inside surface of remote, then forward and inward until Quad Link moves through its complete range and clicks into its fully extended position.

## Maxx Resolve Swing-Away Remote Holder



### CAUTION! Risk of Injury or Damage

Driving the power wheelchair and / or operating the power positioning functions with the remote in the swing-away position may cause collisions or unintended movement.

- Always pay close attention to surroundings when operating the power wheelchair to avoid collisions, damage or unintended movement.
- Always ensure there is sufficient clearance between the armrest pad and the joystick when the remote is in the swing-away position.



### NOTICE!

Applying excessive tension to the front of the remote when operating the swing-away mechanism may cause damage to the internal belt-drive.

- Gentle tension should be applied to the middle of the remote which is closer to the pivot point of the swing-away mechanism. The tension to operate the swing-away mechanism can be set to fit the user's needs, see.



### NOTICE!

Using the joystick to operate the swing away mechanism causes damage to the joystick.

- Do not use the joystick to operate the swing-away mechanism.

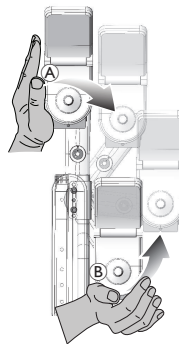

1. Push middle of remote Ⓐ to operate swing-away mechanism.
2. Push forward and inward Ⓑ, until remote locks into home position with a click.

## 6.4.2 Swivelling Nucleus Midline Holder to Side

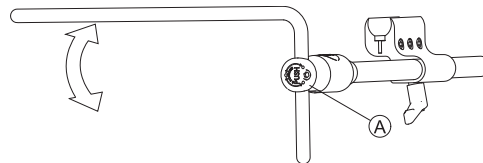

1. Push button Ⓐ and swivel up or down nucleus.

### 6.4.3 Swivelling Swing-Away Display Holder to Side

-  The swing-away display holder only locks in place when swivelled to its default position.

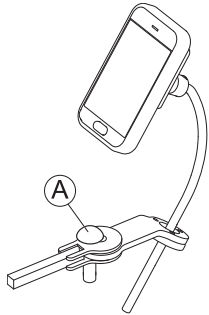

1. Push knob **A** and swivel display holder to side.

### 6.4.4 Swivelling Chin Control to Side

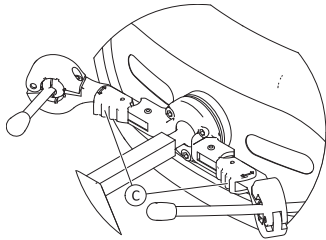

1. Press locking device **C** (behind headrest) and swivel joystick or egg switch inwards or outwards until it clicks in place.

### 6.4.5 Remove / Swing Away the Chest Bar

#### Removing the Chest Bar



1. Lift the chest bar upwards to disengage both posts from left and right mounting brackets **A**.

#### Swinging Away the Chest Bar



1. Lift the chest bar upwards until the shorter post disengages from its mounting bracket **A**.
2. Leave the longer post installed inside its mounting bracket **B**.
3. Swing the chest bar outwards.

### 6.4.6 Stowing the Knee Bolster Assembly

Fig. 6-1 Knee bolster assembly in stowed position

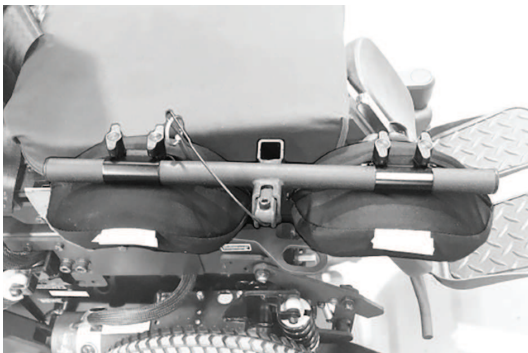

When not needed, the knee bolster assembly can be stowed on a bracket, mounted on one side of the power wheelchair.

1.

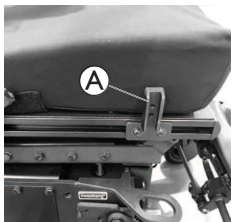

The position of the mounting bracket **A** is on either the left or right rail of the seat.

2.

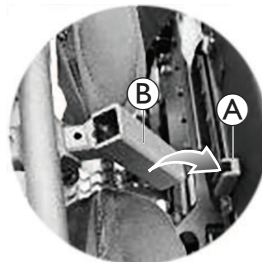

To stow the knee bolster assembly, apply the plunger lock **B** to the mounting bracket **A**.

### Stowing the Mounting Bar



#### CAUTION!

#### Risk of Injury or damage

A lowered mounting bar without the knee bolster mounted can cause injury or damage.

- When the knee bolster is not in use, always keep the retractable mounting bar in the stowed position.

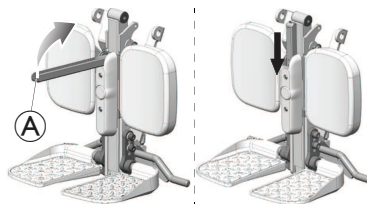

1. Fold up the mounting bar **A** and stow it behind the legrest shroud.
2. For installing the knee bolster assembly, pull the mounting bar upwards and fold it down.

## 6.4.7 Information About Getting in and out



### WARNING!

#### Risk of serious injury or damage

Improper transfer techniques may cause serious injury or damage

- Before attempting transfers, consult a healthcare professional to determine proper transfer techniques for the user and type of wheelchair.
- Follow the instructions below.



If you do not have sufficient muscle strength, you should ask other persons for help. Use a sliding board, if possible.

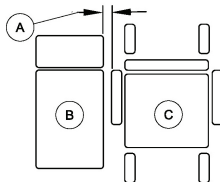

1. Reduce the gap between transfer surface **B** and power wheelchair seat **C** to the minimum distance **A** necessary to perform transfer. This might have to be done by an attendant.
2. Align castors parallel to drive wheels to improve stability during transfer.
3. Always switch your power wheelchair off.
4. Always engage both motor locks / clutches and free wheel hubs (if fitted) to prevent wheels from moving.

5. Depending on armrest type of your power wheelchair, detach armrest or swivel it up.
6. Now slide in or out of your power wheelchair.

## 6.5 Taking Obstacles

### 6.5.1 Maximum Obstacle Height

The maximum obstacle height is:

- Forward: 83 mm
- Reverse: 64 mm

For more information, refer to *11.1 Technical Specifications, page 96*.

### 6.5.2 Safety Information When Taking Obstacles



#### CAUTION!

#### Risk of tipping over

- Never approach obstacles at an angle but at 90 degrees as shown below.
- Approach obstacles followed by a gradient with caution. If unsure whether the gradient is too steep or not, move away from the obstacle and if possible try to find another location.
- Never approach obstacles on an uneven and / or loose ground.
- Never drive with too low tire pressure.
- Put your backrest into an upright position before ascending an obstacle.

**CAUTION!**

**Risk of falling out of the power wheelchair and damage to the power wheelchair such as broken castors**

- Never approach obstacles that are higher than the maximum climbable obstacle height.
- Never let the footrest / legrest touch the ground when descending an obstacle.
- If unsure whether taking an obstacle is possible or not, move away from the obstacle and if possible find another location.

### 6.5.3 Correct Way to Take Obstacles



The following instructions how to take obstacles also apply for attendants if the power wheelchair is fitted with an attendant control.

#### Ascending

*Right*

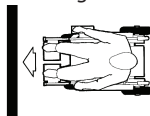

1. Approach obstacle or curb slowly, head-on and at a right angle.
2. Stop in the following position: approx. 30 - 50 cm in front of obstacle.
3. Check position of front wheels. They must be in driving direction and at right angles to obstacle.
4. Approach slowly and keep at consistent speed until rear wheels have also passed over obstacle.

*Wrong*



#### Descending

The approach to descend an obstacle is the same as to ascend it with the difference that you need not to stop before descending.

1. Descend obstacle with medium speed.



## 6.6 Driving up and down Gradients

For information concerning the maximum safe slope, refer to 11.1 *Technical Specifications*, page 96.



### CAUTION!

#### Risk of tipping over

- Only ever drive downhill at a maximum of 2/3 of the top speed. Avoid sudden changes of direction or abrupt braking when driving on slopes.
- Always return the backrest of your seat or the seat tilt (if adjustable seat tilt is available) to an upright position before ascending slopes. We recommend that you position the seat backrest or the seat tilt slightly to the rear before descending slopes.
- Always lower the lifter (if fitted) to its lowest position before ascending or descending a slope.
- Never attempt to ascend or descend a slope on slippery surfaces or where there is a risk of skidding (such as wet pavement, ice etc).
- Avoid trying to get out of the power wheelchair on an incline or a gradient.
- Always drive straight in the direction the road or path you are on goes, rather than attempting to zigzag.
- Never attempt to turn around on an incline or a slope.



### CAUTION!

**Braking distance is much longer on a downhill slope than on even terrain**

- Never drive down a slope that exceeds the rated slope (refer to 11.1 *Technical Specifications*, page 96).

### 6.6.1 Negotiating Inclines

Fig. 6-2 Acceptable Incline Angles 0° to 9°

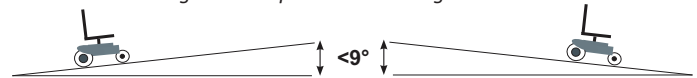
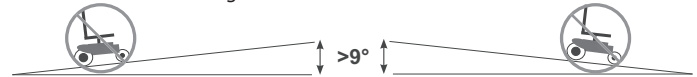

Fig. 6-3 Avoid Inclines above 9°



## 6.7 Reaching, Leaning and Bending

Many activities require the user to reach, lean and bend out of the power wheelchair. These movements can cause a change to the normal balance, centre of gravity and weight distribution of the power wheelchair. To determine and establish your particular safety limits, practice reaching, leaning and bending activities in several combinations in the presence of a qualified healthcare professional before attempting active use of the power wheelchair.

### Forwards



1. Align castors parallel to the drive wheels to improve stability.
2. Engage motor locks.
3. Turn off mobility device.
4. Reach, lean or bend only as far as your arm extends without changing your sitting position.

### Backwards



1. Position mobility device as close as possible to desired object.
2. Align castors parallel to the drive wheels to improve stability.
3. Engage motor locks.
4. Turn off mobility device.
5. Reach back only as far as your arm extends without changing your sitting position.

## 6.8 Use on Public Roads

If you wish to use your power wheelchair on public roads and lighting is required by national legislation, then your power wheelchair needs to be fitted with an appropriate lighting system. Additional modifications may be required depending on the country.

Contact your Invacare provider if you have any questions.

## 6.9 Pushing the Power Wheelchair in Freewheel Mode

The motors of the power wheelchair are equipped with automatic brakes, preventing that the power wheelchair starts rolling out of control when the remote is switched off. When pushing the power wheelchair manually whilst freewheeling, the magnetic brakes must be disengaged.

 Pushing the power wheelchair by hand may require more physical force than expected (more than 100 N). The necessary force nevertheless complies with the requirements of ISO 7176-14.

 The intended use of the freewheel mode is to maneuver the power wheelchair over short distances. The push handles or push bars support this function, but be aware that there might be some impairment between the feet of the assistant and the rear part of the power wheelchair.

### 6.9.1 Disengaging Motors



#### CAUTION!

#### Risk of the power wheelchair running away

— When the motors are disengaged (for push operation whilst freewheeling), the electromagnetic motor brakes are deactivated. When the power wheelchair is parked, the levers for engaging and disengaging the motors must without fail be locked firmly into the "DRIVE" position (electromagnetic motor brakes activated).

 The motors may only be disengaged by an attendant, not by the user.

This ensures that the motors are only disengaged if an attendant is available to secure the power wheelchair and prevent unintended rolling.

The levers for disengaging the motors are located behind the motors.

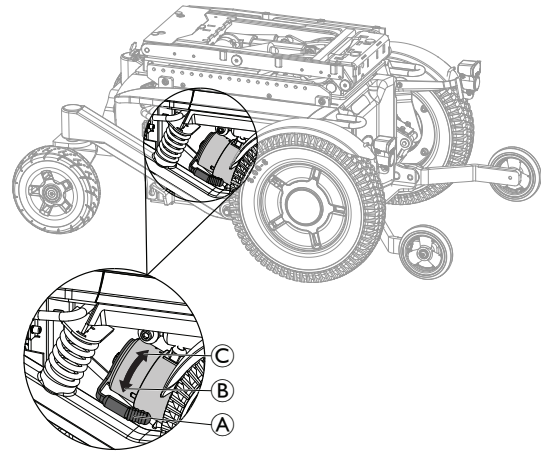

#### Disengaging Motors

1. Switch off remote.
2. Turn the engaging lever **A** upwards **C**.  
The motors are now disengaged.

#### Re-engaging Motors

1. Turn the engaging lever **A** down **B**.  
The motors are now re-engaged.

## 7 Control System

### 7.1 Control Protection System

The power wheelchair control system is fitted with an overload protection.

If the drive is severely overloaded over a long period of time (for example, when driving up a steep hill) and especially when the ambient temperature is high, the control system could overheat. In this case, the wheelchair performance is gradually reduced until it comes to a halt. The status display shows a corresponding error code (refer to the user manual of your remote). By switching the remote off and back on again, the error code is cleared and the control system is switched back on. It can however take up to five minutes until the control system has cooled down enough for the drive to restore full performance again.

If the drive is stalled by an insurmountable obstacle, for example, a curb or similar which is too high, and the driver attempts driving for more than 20 seconds against this obstacle, the control system automatically switches off to prevent the motors from being damaged. The status display shows a corresponding error code (refer to the user manual of your remote). By switching the remote off and back on again, the error code is cleared and the control system is switched back on.

#### 7.1.1 Using Circuit Breaker



The circuit breaker must not be used as an ON/OFF button.

When the circuit breaker is used, the LiNX system could lose information such as the correct time displayed on the remote.



There is no need to use the circuit breaker when transporting the power wheelchair in a vehicle.



The power wheelchair cannot be charged when the circuit breaker is turned off.



A defective circuit breaker may be replaced only after checking the entire control system. A specialised Invacare provider must perform the replacement. For more information about the circuit breaker type, see .

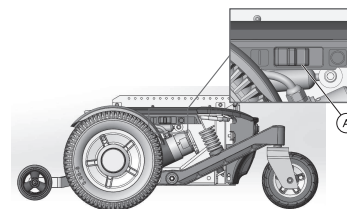

FRONT of wheelchair

BACK of wheelchair

The circuit breaker Ⓐ is located on the left side of the battery box.

The circuit breaker is an additional safety feature of the control protection system. When the system is overloaded, the circuit breaker turns off automatically. In a hazardous situation or when the power wheelchair starts to behave erratically, the circuit breaker can be used to isolate the battery source quickly.

It can also be used to turn off the power supply of the power wheelchair manually, when the power wheelchair is transported without surveillance, for example, while travelling by air, refer to 8.3 *Transporting Power Wheelchair Without Occupant*, page 83.

1. To turn off power supply manually, move circuit breaker switch towards BACK of wheelchair.

2. If circuit breaker turned off automatically or manually, move circuit breaker switch towards FRONT of wheelchair to turn on power supply again.

## 7.2 Batteries

Power is supplied by two 12 V batteries. The batteries are maintenance-free and only need regular charging.

In the following, you find information on how to charge, handle, transport, store, maintain, and use batteries.

### 7.2.1 General Information on Charging

New batteries should always be fully charged once before their first use. New batteries will be at their full capacity after having run through approx. 10 - 20 charging cycles (break-in period). This break-in period is necessary to fully activate the battery for maximum performance and longevity. Thus, range and running time of your power wheelchair could initially increase with use.

Gel/AGM lead acid batteries do not have a memory effect as NiCd batteries.

### 7.2.2 General Instructions on Charging

Follow the instructions listed below to ensure safe use and longevity of the batteries:

- Charge 18 hours prior to initial usage.
- We recommend charging the batteries daily after every discharge even after partly discharge, as well as each night over night. Depending on the level of discharge, it can take up to 12 hours until the batteries are fully charged again.

- When the battery indicator reached the red LED range, charge the batteries for 16 hours minimum, neglecting the charge complete display!
- Try to provide a 24 hour charge once a week to make sure that both batteries are fully charged.
- Do not cycle your batteries at a low state of charge without regularly recharging them fully.
- Do not charge your batteries under extreme temperatures. High temperatures above 30 °C are not recommended for charging as well as low temperatures below 10 °C.
- Use only charging devices in Class 2. This class of chargers may be left unattended during charging. All charging devices which are supplied by Invacare comply with these requirements.
- You cannot overcharge the batteries when using the charger supplied with your power wheelchair, or a charger that has been approved by Invacare.
- Protect your charger from sources of heat such as heaters and direct sunlight. If the battery charger overheats, charging current will be reduced and the charging process delayed.

### 7.2.3 Charging Batteries

Refer to the user manuals for your remote and battery charger for the position of the charging socket and further information about charging the batteries.



#### **WARNING!**

#### **Risk of injury if using the power wheelchair during charging**

- DO NOT attempt to recharge the batteries and operate the power wheelchair at the same time.
- DO NOT sit in the power wheelchair while charging the batteries.



#### **WARNING!**

#### **Risk of fire**

- Only charge the power wheelchair in a well-ventilated environment to prevent the accumulation of flammable gas.
- During the charging process explosive gases occur. Keep the power wheelchair and the charger away from sources of ignition such as flames and sparks.



#### **WARNING!**

#### **Risk of explosion and destruction of batteries if the wrong battery charger is used**

- Only ever use the battery charger supplied with your power wheelchair, or a charger that has been approved by Invacare.



#### **WARNING!**

#### **Risk of electric shock and damage to the battery charger if it gets wet**

- Protect the battery charger from water.
- Always charge in a dry environment.



#### **WARNING!**

#### **Risk of short circuit and electric shock if the battery charger has been damaged**

- Do not use the battery charger if it has been dropped or damaged.



#### **WARNING!**

#### **Risk of electric shock and damage to the batteries**

- NEVER attempt to recharge the batteries by attaching cables directly to the battery terminals.



#### **WARNING!**

#### **Risk of fire and electric shock if a damaged extension cable is used**

- Only ever use an extension cable if it is absolutely necessary. In case you must use one, make sure it is in good condition.

1. Switch off power wheelchair.
2. Connect battery charger to charger socket.
3. Connect battery charger to power supply.



The batteries are equipped with safety vents that allow for the evaporation of gas which is generated during the charging process. If the safety vents cannot release the gas properly, the batteries may overheat and permanently deform. An unpleasant smell and reduced function of the batteries may be noticed. However, the batteries remain safe. Stop charging immediately and let the power wheelchair cool down. Please contact your provider to exchange the batteries.

### 7.2.4 Disconnecting Power Wheelchair after Charging

1. Once charging is complete, first disconnect battery charger from power supply, then disconnect plug from remote.

### 7.2.5 Storage and Maintenance

Follow the instructions listed below to ensure safe use and longevity of the batteries:

- Always store the power wheelchair fully charged.
- Do not leave the batteries in a low state of charge for an extended length of time. Charge a discharged battery as soon as possible.
- In case your power wheelchair is not used for a longer period of time (that is more than two weeks), the batteries must be charged at least once a month to maintain a full charge and always be charged before use.
- Avoid hot and cold extremes when storing. We recommend to store power wheelchair at a temperature of 15 °C.
- Gel and AGM batteries are maintenance-free. Any performance issues should be handled by a properly trained power wheelchair technician.

### 7.2.6 Instructions on Using Batteries



#### **CAUTION!**

#### **Risk of damaging the batteries.**

- Avoid ultra-deep discharges and never drain your batteries completely.

- Pay attention to the Battery Charge Indicator! Charge the batteries when the Battery Charge Indicator shows that battery charge is low. How fast the batteries discharge depends on many circumstances, such as ambient temperature, condition of the surface of the road, tire pressure, weight of the driver, way of driving and utilisation of lighting, if fitted.
- Always try to charge the batteries, before the indicator on the remote is displaying the state of charge with red colour. The red colour means a remaining capacity about 20 %.
- When the red LED is flashing, the Battery Safe feature is enabled. From this time, speed and acceleration is reduced drastically. It will allow you to move the power wheelchair slowly out of a dangerous situation before the electronic finally cuts off. This is deep discharging and should be avoided.
- Driving with flashing red LED means an extreme stress for the battery and should be avoided under normal circumstances.
- Be aware that for temperatures below 20 °C, the nominal battery capacity starts to decline. For example, at -10 °C the capacity is reduced to about 50 % of the nominal battery capacity.

- To avoid damaging the batteries, never allow them to be fully discharged. Do not drive on heavily discharged batteries if it is not absolutely necessary, as this will strain the batteries unduly and shorten their life expectancy.
- The earlier you recharge the batteries, the longer they live.
- The depth of discharge affects the cycle life. The harder a battery has to work, the shorter is its life expectancy. Examples:
  - One deep discharge stresses the same as 6 normal cycles (green / orange display off).
  -  The battery indicator or number of LED can vary depending on the remote type.

The battery life is about 500 cycles at 80 % discharge (first 4 LED off / battery bar displays red), or about 5000 cycles at 10 % discharge (one LED off / battery bar displays green).
- Under normal operation, once a month the battery should be discharged until all green and orange LED are off or until battery bar displays red. This should be done within one day. A 16 hour charge afterwards is necessary as reconditioning.

### 7.2.7 Transporting Batteries

The batteries supplied with your power wheelchair are not hazardous goods. This classification is based on the German GGVS Hazardous Goods Road Transport Ordinances, and the IATA/DGR Hazardous Goods Rail Transport / Air Transport Ordinances. Batteries may be transported without restrictions, whether by road, rail or by air. Individual transport companies have, however, guidelines which can possibly restrict or forbid certain transport procedures. Please ask the transport company regarding each individual case.

### 7.2.8 General Instructions on Handling Batteries

- The batteries reach their end of life when the drive range is significantly smaller than usual. Contact your provider or service technician for details.
- Always have your batteries installed by a properly trained power wheelchair technician or a person with adequate knowledge. They have the necessary training and tools to do the job safely and correctly.



### 7.2.9 Handling Damaged Batteries Correctly

If the batteries are defective or damaged, the power wheelchair must not be used under any circumstances. Contact your provider regarding a repair or exchanging the batteries.

Damaged batteries shall only be handled by a properly trained power wheelchair technician.



#### **WARNING!**

##### **Risk of burns**

- Never touch or remove overheating batteries. Only unplug the charger.
- Never touch leaking batteries.



#### **CAUTION!**

##### **Corrosion and burns from acid leakage if batteries are damaged**

- Remove clothes that have been soiled by acid immediately.

##### **After contact with skin:**

- Immediately wash affected area with lots of water.

##### **After contact with eyes:**

- Immediately rinse eyes under running water for several minutes; consult a physician.

### Disposing of Dead or Damaged Batteries Correctly

Batteries are following special disposal rules. Your provider has all information available to safely exchange and dispose the defect batteries.

## 8 Transport

### 8.1 General Information on Transport

This power wheelchair may NOT be used as a vehicle seat, this is identified by the following label:



#### **WARNING!**

**Risk of death or serious injury to the power wheelchair user and potentially any other nearby occupant of the vehicle, if a power wheelchair is secured using a 4-point tie-down system available from a third party supplier and the unladen weight of the power wheelchair exceeds the maximum weight for which the tie-down system is certified**

- Make sure the weight of the power wheelchair does not exceed the weight for which the tie-down system is certified. Consult the tie-down manufacturer's documentation.
- If you are unsure how much your power wheelchair weighs, then you must have it weighed using calibrated scales.



#### **NOTICE!**

- The vehicle should have the floor strength to take the combined weight of the occupant, the mobility device and accessories.

### 8.2 Transferring Power Wheelchair to Vehicle



#### **WARNING!**

**Power wheelchair is at risk of tipping over if transferred to a vehicle while user is still seated in power wheelchair**

- Transfer power wheelchair without user whenever possible.
- If power wheelchair with user must be transferred to vehicle using a ramp, ensure that ramp does not exceed rated slope.
- If power wheelchair must be transferred to vehicle using a ramp that does exceed rated slope, a winch must then be used. An attendant can then safely monitor and assist transfer process.
- Alternatively, a platform lift may be used.
- Ensure that total weight of power wheelchair including user does not exceed maximum permitted total weight for ramp or platform lift.
- Power wheelchairs should always be transferred to vehicle with backrest in upright position, seat lifter lowered and tilt in upright position (refer to *6.6 Driving up and down Gradients, page 73*).



**WARNING!**

**Risk of injury and damage to power wheelchair and vehicle**

Risk of tipping over or uncontrolled movements of power wheelchair if transferred to vehicle using a ramp that exceeds rated slope.

- Transfer power wheelchair to vehicle without user.
- An attendant must assist transfer process.
- Ensure that all carer fully understand manual of ramp and winch.
- Ensure that winch is suitable for your power wheelchair.
- Use only suitable tie-down points. Do not use removable or movable components of power wheelchair as tie-down points.



**WARNING!**

**Risk of injury and damage to power wheelchair**

If power wheelchair must be transferred to vehicle via a lift, when remote is turned on, there is a risk that device may act erratically and fall off lift.

- Before transferring power wheelchair via lift, turn off product and disconnect either bus cable from remote or batteries from system.

1. Drive or push your power wheelchair into transport vehicle using suitable ramp.

### 8.3 Transporting Power Wheelchair Without Occupant



**CAUTION!**

**Risk of injury**

- If you are unable to fasten your power wheelchair securely in a transport vehicle, Invacare recommends that you do not transport it.

Your power wheelchair may be transported without restrictions, whether by road, rail or by air. Individual transport companies have, however, guidelines which can possibly restrict or forbid certain transport procedures. Please ask the transport company regarding each individual case.

- Before transporting your power wheelchair, make sure the motors are engaged and that the remote is switched off.
- Invacare strongly recommends that you additionally disconnect or remove the batteries. Refer to "Removing the Batteries" in the corresponding Service Manual, which can be obtained from Invacare.
- Invacare strongly recommends securing the power wheelchair to the floor of the transporting vehicle.

---

## 9 Maintenance

---

### 9.1 Maintenance Introduction

The term “Maintenance” means any task performed to ensure that a medical device is in good working order and ready for use as intended. Maintenance encompasses different areas, such as everyday care and cleaning, inspection checks, repair tasks and refurbishment.



It is recommended, to have your power wheelchair checked once a year by an authorised Invacare provider to maintain its driving safety and roadworthiness.

### 9.2 Inspection Checks

The following tables list inspection checks that should be performed by the user and their intervals. If the power wheelchair fails to pass one of the inspection checks, refer to the chapter indicated or contact your authorised Invacare provider. A more comprehensive list of inspection checks and instructions for maintenance work can be found in the service manual for this device, which can be obtained from Invacare. That manual, however, is intended to be used by trained and authorised service technicians, and describes tasks which are not intended to be performed by the user.

### 9.2.1 Before Each Use of Power Wheelchair

Item	Inspection Check	If Not Passed
Screwed connections	Check all connections, such as backrests and wheels, for tight fit.	Contact your provider.
Signal horn	Check for correct function.	Contact your provider.
Lighting system	Check that all lights, such as turn indicators, head lamps and tail lights, are functioning correctly.	Contact your provider.
Battery box locking system	Check to ensure that the battery box locking system is functioning correctly. Locking pins must be completely engaged in the holes provided for them (refer to <i>8.3 Transporting Power Wheelchair Without Occupant, page 83</i> ).	Contact your provider.
Batteries	Make sure the batteries are charged. See the user manual provided with your remote for a description of the battery charge indicator.	Charge the batteries (refer to <i>7.2.3 Charging Batteries, page 78</i> ).

### 9.2.2 Weekly

Item	Inspection Check	If Not passed
Armrests / side parts	Check that armrests are firmly attached in their holders and do not wobble.	Tighten the screw or clamping lever that holds the armrest. Contact your provider.
Tires (pneumatic)	Check that the tires are undamaged.	Contact your provider.
	Check that the tires are inflated to the correct pressure.	Inflate the tire to the correct pressure (refer to <i>9.3 Wheels and Tyres, page 90 and , page 1</i> ).
Tires (puncture-proof)	Check that the tires are undamaged.	Contact your provider.
Antitippers	Check that antitippers are firmly attached and do not wobble.  Check that the spring clips of the antitippers are in good order and secure the antitippers correctly.	Contact your provider.

## 9.2.3 Monthly

Item	Inspection check	If inspection is not passed
All upholstered parts	Check for damage and wear.	Contact your provider.
Removable legrests	Check whether the legrests can be fixed securely and whether the loosening mechanism is properly operable.	Contact your provider.
	Check that all adjustment options function properly.	Contact your provider.
Castors	Check that castors rotate and swivel freely.	Contact your provider.
Chest belt	Check that the chest belt is fitting tightly.	Contact your provider.
	Check the hook-and-loop strap for correct function and that it may not open by itself.	Contact your provider.
Drive wheels	Check that the drive wheels rotate without wobbling. It is easiest to have someone stand behind the mobility device and observe the drive wheels as you drive away from them to do this.	Contact your provider.
Electronics and connectors	Check all cables for damage and all connecting plugs for snug fit.	Contact your provider.
Adjustment options	Check that all adjustment options function properly.	Contact your provider.
Mountings/bolts	Check that all mountings/bolts are tight and secure.	Contact your provider.

### 9.2.4 Performance Troubleshooting



For additional troubleshooting information regarding the power wheelchair & electronics, refer to the Troubleshooting section of the power wheelchair and remote user manuals (provided separately).

Symptom	Probable cause	Solutions
Wheelchair power is ON, but system does not drive	System tilted and/or elevated beyond the drive lockout (DLO) angle	Return seating system to neutral (home) position.
	Drive motors not engaged	Engage drive motors.
	LNX powered central legrest with telescoping footboard lowered	Retract footboard to top position.
Seating system not functioning	Low batteries	Check/charge/replace batteries. Contact your provider.
	Loose/faulty electrical connection	Check cable connections/check cable ties (too tight/too loose). Contact your provider.
	Blown fuse	Inspect/replace fuse. Contact your provider.
	Interference/obstructions, pinched wires	Check for sources of interference or obstructions/inspect cables for pinch points. Contact your provider.

Symptom	Probable cause	Solutions
Intermittent seating system functions (day to day, during tilt, during recline...)	Loose/faulty electrical connection	Check cable connections/check cable ties (too tight/too loose).
	Faulty power harness	Check/replace power harness. Contact your provider.
	Faulty limit switch	Check/replace limit switch. Contact your provider.
	Nearly exhausted battery (fluctuating charge)	Check/replace battery. Contact your provider.
Drive lockout (DLO) is not functioning	Loose/faulty electrical connection	Check connections. Contact your provider.
	DLO limit switch/mechanical switch is not set properly	Contact your provider.
	Faulty DLO limit switch	Contact your provider.
Limit switch not functioning properly	Loose/faulty electrical connection	Check connections. Contact your provider.
	Faulty limit switch	Check/replace limit switch. Contact your provider.
	Limit switch is not set-up properly	Contact your provider.



Symptom	Probable cause	Solutions
System only operates in one direction	Limit is exceeded (DLO, RDS, back angle, elevating seat lockout)	Come within limit ranges.
	Faulty limit switch	Check/replace limit switch. Contact your provider.
	Limit switch is not set-up properly	Contact your provider.
	Low voltage	Contact your provider.
	Battery not charged	Charge batteries.
Remote will not function	Remote not plugged in	Inspect cable connection.
	Remote not turned on	Turn on power to the remote via the keypad.
	Blown base fuse	Inspect/replace fuse. Contact your provider.
Actuator keeps running	Pinched switch harness	Inspect/adjust harness position to prevent pinching. Contact your provider.

## 9.3 Wheels and Tyres

### Dealing With Wheel Damages

In case of having a damaged wheel, contact your provider. Because of safety reasons do not have the wheel repaired by yourself or by not authorised persons.

### Dealing With Pneumatic Tyres

#### **!** NOTICE! Risk of damage to tyre and rim

Never drive with too low tyre pressure, this could result in damage to tyre.

If tyre pressure is exceeded rim could be damaged.

- Inflate tyres to recommended pressure.



Use tyre gauge to check pressure.

Check weekly that the tyres are inflated to the correct pressure, refer to *9.2.1 Before Each Use of Power Wheelchair, page 85*.

For recommended tyre pressure see inscription on tyre / rim or contact Invacare. Compare table below for conversion.

psi	bar
22	1.5
23	1.6
25	1.7
26	1.8

psi	bar
28	1.9
29	2.0
30	2.1
32	2.2
33	2.3
35	2.4
36	2.5
38	2.6
39	2.7
41	2.8
44	3.0

## 9.4 Short-Term Storage

In case a serious fault is detected, a number of safety mechanisms are built into your power wheelchair and will protect it. The power module prevents your power wheelchair from driving.

When the power wheelchair is in such a condition and while waiting for repair:

1. Switch off power.
2. Disconnect the batteries.

Depending on the power wheelchair model, you can either remove the battery packs or disconnect the batteries from the power module. Refer to the corresponding chapter about

disconnecting the batteries in the service manual, which is available through Invacare.

3. Contact your provider.

## 9.5 Long-Term Storage

In case your power wheelchair is not used for a longer period of time, you need to prepare it for storage to ensure a longer life for your power wheelchair and batteries.

### Storing Power Wheelchair and Batteries

- We recommend to store the power wheelchair at a temperature of 15 °C, avoid hot and cold extremes when storing to ensure a long service life of the product and batteries.
- The components are tested and approved for greater temperature ranges as detailed below:
  - Allowable temperature range to store the power wheelchair is -40° up to 65 °C.
  - Allowable temperature range to store batteries is -25° up to 65 °C.
- Even not being used, batteries discharge themselves. Best practice is to disconnect the battery supply from the power module if storing the power wheelchair longer than two weeks. Depending on the power wheelchair model, you can either remove the battery packs or disconnect the batteries from the power module. Refer to the corresponding chapter about disconnecting the batteries in the service manual, which is available through Invacare. If in doubt which cable to disconnect, contact your provider.
- Batteries should always be fully charged before storing.

- If storing the power wheelchair longer than four weeks, check the batteries once a month and recharge as needed (before gauge reads half full) to avoid damage.
- Store in a dry, well-ventilated environment protected from outer influences.
- Slightly overinflate pneumatic tyres.
- Position the power wheelchair on flooring that is not discoloured by contact with tyre rubber.

### Preparing Power Wheelchair for Use

- Re-connect the battery supply to the power module.
- The batteries must be charged before use.
- Have the power wheelchair checked by an authorised Invacare provider.

## 9.6 Cleaning and Disinfection

### 9.6.1 General Safety Information



#### **CAUTION!**

#### **Risk of Contamination**

- Take precautions for yourself and use appropriate protective equipment.

**CAUTION!****Risk of Electric Shock and Product Damage**

- Switch off the device and disconnect from mains, if applicable.
- When cleaning electronic components consider their protection class regarding water ingress.
- Make sure that no water splashes to the plug or the wall outlet.
- Do not touch the power socket with wet hands.

**NOTICE!**

- Wrong fluids or methods can harm or damage the product.
- All cleaning agents and disinfectants used must be effective, compatible with one another and must protect the materials they are used to clean.
  - Never use corrosive fluids (alkalines, acid etc.) or abrasive cleaning agents. We recommend an ordinary household cleaning agent such as dishwashing liquid, if not specified otherwise in the cleaning instructions.
  - Never use a solvent (cellulose thinner, acetone etc.) that changes the structure of the plastic or dissolves the attached labels.
  - Always make sure that the product is completely dried before taking into use again.



For cleaning and disinfection in clinical or long-term care environments, follow your in-house procedures.

**9.6.2 Cleaning Intervals****NOTICE!**

Regular cleaning and disinfection enhance smooth operation, increases the service life and prevents contamination.

Clean and disinfect the product:

- regularly while in use,
- before and after any service procedure,
- when it has been in contact with any body fluids,
- before using it for a new user.

**9.6.3 Cleaning****NOTICE!**

- The product does not tolerate cleaning in automatic washing plants, with high-pressure cleaning equipment or steam.

**NOTICE!**

Dirt, sand and seawater can damage the bearings and steel parts can rust if the surface is damaged.

- Only expose the wheelchair to sand and seawater for short periods and clean it after every trip to the beach.
- If the wheelchair is dirty, wipe off the dirt as soon as possible with a damp cloth and dry it carefully.

1. Remove any installed optional equipment (only optional equipment which does not require tools).

2. Wipe down the individual parts using a cloth or soft brush, ordinary household cleaning agents (pH = 6 - 8) and warm water.
3. Rinse the parts with warm water.
4. Thoroughly dry the parts with a dry cloth.



Car polish and soft wax can be used on painted metal surfaces to remove abrasions and restore gloss.

### Cleaning upholstery

For cleaning upholstery refer to the instructions on the labels of the seat, cushion and backrest cover.



#### NOTICE!

- Do not use cleaning and disinfection agents with abrasive, staining or polymer-damaging properties such as phenols, alcohols or bleaches.
- Chlorine solutions used even in low concentrations on a regular basis can diminish the life of the cover.



If possible, always overlap hook and loop strips (the self-gripping parts) when washing, to minimize lint and thread build-up on hook strips and prevent damage to upholstery fabric by these.

### 9.6.4 Disinfection Instructions

Method: Follow the application notes for the used disinfectant and wipe-disinfect all accessible surfaces.

Disinfectant: Ordinary household disinfectant.

Drying: Allow the product to air-dry.

## 9.7 Seating Module Lubrication



#### NOTICE!

To maintain the smooth operation of the MPS system, periodical lubrication of the main pivot points is recommended. The MPS system is pre-lubricated at the factory, however occasional lubrication using a general purpose oil helps to maintain optimal performance of the MPS system.

- Do not use heavy grease or high viscosity lubricants as this can cause a build-up of dirt and contaminates which could reduce overall performance.

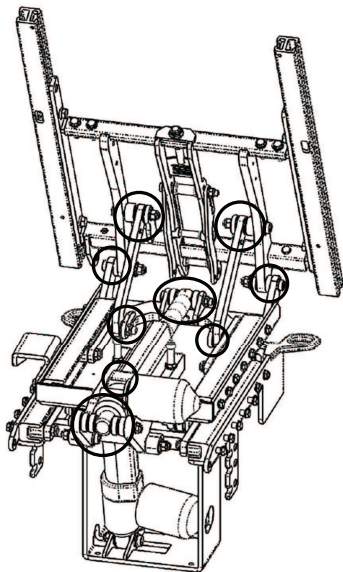

1. Adjust MPS system to full stand.
2. Power down mobility device.
3. Use cloth to wipe away any dirt, residue around pivots and along glide channels.
4. Lubricate main pivot points periodically using a general purpose oil.

## 10 After Use

### 10.1 Reconditioning

This product is suitable for reuse. To recondition the product for a new user, carry out the following actions:

- Inspection according to service plan. See service manual, which is available through Invacare.
- Cleaning and disinfection, refer to *9.6 Cleaning and Disinfection, page 91*.
- Adaptation to the new user, refer to *5 Setup, page 36*.

Make sure that the user manual is handed over with the product.

If any damage or malfunction is detected, do not reuse the product.

### 10.2 Disposal



#### **WARNING!**

#### **Environmental Hazard**

Device contains batteries.

This product may contain substances that could be harmful to the environment if disposed of in places (landfills) that are not appropriate according to legislation.

- DO NOT dispose of batteries in normal household waste.
- DO NOT throw batteries into a fire.
- Batteries **MUST** be taken to a proper disposal site. The return is required by law and free of charge.
- Only dispose of discharged batteries.
- Cover terminals of batteries prior to disposal.
- For information about the correct handling of damaged batteries, refer to *7.2.9 Handling Damaged Batteries Correctly, page 81*.

Be environmentally responsible and recycle this product through your recycling facility at its end of life.

Disassemble the product and its components, so the different materials can be separated and recycled individually.

The disposal and recycling of used products and packaging must comply with the laws and regulations for waste handling in each country. Contact your local waste management company for information.

## 11 Technical Data

### 11.1 Technical Specifications

The technical information provided hereafter applies to a standard configuration or represents maximum achievable values. These can change if accessories / options are added. The precise changes to these values are detailed in the sections for the respective accessories / options.

Note that there may be values in this list, which are not relevant to your product, since this list applies to all available models (on the date of printing). If not otherwise stated, each value in this list refers to all models of the product.

The models and configurations available in your country can be found in the country-specific sales documents.



Note that in some cases the measured values may vary up to  $\pm 10$  mm.

Permissible Operating and Storage Conditions	
Temperature Range for Operation According to ISO 7176-9	<ul style="list-style-type: none"> <li>-25 °C – +50 °C</li> </ul>
Recommended Storage Temperature	<ul style="list-style-type: none"> <li>+15 °C</li> </ul>
Temperature Range for Storage According to ISO 7176-9	<ul style="list-style-type: none"> <li>-25 °C – +65 °C with batteries</li> <li>-40 °C – +65 °C without batteries</li> </ul>

Electrical System	
Motors	<ul style="list-style-type: none"> <li>2x 340 W (12 km/h)</li> </ul>
Batteries <sup>1</sup>	<ul style="list-style-type: none"> <li>60 Ah (C5) sealed VRLA gel</li> </ul>
Main Fuse	<ul style="list-style-type: none"> <li>63 A</li> </ul>
Degree of Protection	<ul style="list-style-type: none"> <li>IPX4<sup>2</sup></li> </ul>



Charging Device	
Output Current	<ul style="list-style-type: none"> <li>• 10 A</li> </ul>
Output Voltage	<ul style="list-style-type: none"> <li>• 24 V nominal</li> </ul>

Drive Wheel Tyres	
Tyre Type	<ul style="list-style-type: none"> <li>• 14 inch puncture-proof, pneumatic</li> </ul>
Tyre Pressure	<p>The recommended maximum tyre pressure in bar or kpa is marked on the side wall of the tyre or the rim. If more than one value is listed, the lower one in the corresponding units applies.</p> <p>(Tolerance = -0.3 bar, 1 bar = 100 kpa)</p>

Castor Tyres	
Tyre Type	<ul style="list-style-type: none"> <li>• 8 inch puncture-proof</li> </ul>
Tyre Pressure	<p>The recommended maximum tyre pressure in bar or kpa is marked on the side wall of the tyre or the rim. If more than one value is listed, the lower one in the corresponding units applies.</p> <p>(Tolerance = -0.3 bar, 1 bar = 100 kpa)</p>

Driving Characteristics	
Speed	<ul style="list-style-type: none"> <li>• 12 km/h</li> </ul>
Max. Stopping Distance:	
Normal Operation	<ul style="list-style-type: none"> <li>• 2230 mm</li> </ul>
Emergency Operation	<ul style="list-style-type: none"> <li>• 1800 mm</li> </ul>
Max. Climbable Obstacle Height	<ul style="list-style-type: none"> <li>• Forward: 83 mm</li> <li>• Reverse: 64 mm</li> </ul>

<b>Driving Characteristics</b>	
Rated Slope <sup>3</sup>	<ul style="list-style-type: none"> <li>• 9°</li> </ul>
Max. Slope with Engaged Parking Brakes	<ul style="list-style-type: none"> <li>• 15.2°</li> </ul>
Lateral Dynamic Stability:	
Min. Diameter for Turning in Circles at max. Speed	<ul style="list-style-type: none"> <li>• 5300 mm</li> </ul>
Stable While Turning Suddenly	<ul style="list-style-type: none"> <li>• Yes</li> </ul>
Continuous Driving Distance Range in Accordance with ISO 7176-4 <sup>4</sup>	<ul style="list-style-type: none"> <li>• 27.07 km</li> </ul>
Manoeuvring Distance Range in Accordance with ISO 7176-4 <sup>4</sup>	<ul style="list-style-type: none"> <li>• 7.11 km</li> </ul>
Turning Diameter	<ul style="list-style-type: none"> <li>• 1360 mm</li> </ul>
Pivot Width	<ul style="list-style-type: none"> <li>• 1240 mm</li> </ul>
Required Width of Angled Corridor	<ul style="list-style-type: none"> <li>• 785 mm</li> </ul>
Required Doorway Entry Depth	<ul style="list-style-type: none"> <li>• 1439 mm</li> </ul>
Required Corridor Width for Side Opening	<ul style="list-style-type: none"> <li>• 842 mm</li> </ul>

<b>Dimensions According to ISO 7176-5</b>	
Seat-to-Floor Height <sup>5</sup>	<ul style="list-style-type: none"> <li>• 470 mm</li> </ul>

<b>Dimensions According to ISO 7176-5</b>	
	<ul style="list-style-type: none"> <li>• 495 mm</li> </ul>
Max. Total Height	<ul style="list-style-type: none"> <li>• 1115 – 1445 mm</li> </ul>
Max. Total Width (depending on Seat Width and Base Width)	<ul style="list-style-type: none"> <li>• 740 – 890 mm</li> </ul>
Total Length ( with central legrest)	<ul style="list-style-type: none"> <li>• 1250 – 1305 mm</li> </ul>
Stowage Length	<ul style="list-style-type: none"> <li>• 1070 mm</li> </ul>
Stowage Width	<ul style="list-style-type: none"> <li>• 604 mm</li> </ul>
Stowage Height	<ul style="list-style-type: none"> <li>• 1115 – 1445 mm</li> </ul>
Ground Clearance	<ul style="list-style-type: none"> <li>• 80 mm</li> </ul>

<b>Dimensions of Seating System According to ISO 7176-5</b>	
Seat Width	<ul style="list-style-type: none"> <li>• 405 – 510 mm</li> </ul>
Seat Depth	<ul style="list-style-type: none"> <li>• 405 – 510 mm</li> </ul>
Seat Cushion Thickness	<ul style="list-style-type: none"> <li>• 75/90/100 mm</li> </ul>
Backrest Angle	<ul style="list-style-type: none"> <li>• 90° ... 170°</li> <li>• 82° ... 162° (8° precline mount)</li> <li>• 60° ... 140° (30° precline mount)</li> </ul>
Backrest Height <sup>5</sup>	<ul style="list-style-type: none"> <li>• 305 – 710 mmm</li> </ul>
Armrest Height	<ul style="list-style-type: none"> <li>• 241 – 330 mm / 320 - 405 mm (backpost mounted flip back cantilever armrest)</li> <li>• 230 – 330 mm / 330 - 405 mm (two-post flip back recline armrest)</li> </ul>

Dimensions of Seating System According to ISO 7176-5		
Armrest Depth <sup>6</sup>		<ul style="list-style-type: none"> <li>• 230 – 470 mm</li> </ul>
Max. Armrest Weight		<ul style="list-style-type: none"> <li>• 1.7 kg</li> </ul>
Max. Headrest Weight		<ul style="list-style-type: none"> <li>• 1.4 kg</li> </ul>
Seat Angle		<ul style="list-style-type: none"> <li>• -5° ... 40° (with 5° fixed anterior mount)</li> <li>• -10° ... 35° (with 10° fixed anterior mount)</li> <li>• 0° ... 45° (standard mount)</li> <li>• 5° ... 50° (with 5° posterior mount)</li> </ul>
Footrests and Legrests		
Centre-mounted Powered Legrest <sup>7</sup>	Length	<ul style="list-style-type: none"> <li>• 190 – 210 kg</li> </ul>
	Angle	<ul style="list-style-type: none"> <li>• +97° – +7°</li> <li>• +90° – 0°</li> <li>• +83° – -7°</li> </ul>
Kerb Weight <sup>8</sup>		
		<ul style="list-style-type: none"> <li>• 190 – 210 kg</li> </ul>
Component Weights		
60 Ah Batteries		<ul style="list-style-type: none"> <li>• approx. 20 kg per battery</li> </ul>
Payload		
Max. occupant mass		<ul style="list-style-type: none"> <li>• 113 kg</li> </ul>

Axle Loads	
Max. Front Axle Load	<ul style="list-style-type: none"> <li>• 259 kg</li> </ul>
Max. Rear Axle Load	<ul style="list-style-type: none"> <li>• 103 kg</li> </ul>

- 1 Usable battery capacity depending on the discharge time.  
C5: Discharge over a period of 5 hours.
- 2 IPX4 classification means that the electrical system is protected against spray water.
- 3 Static stability downhill, uphill, and sideways according to ISO 7176-1 = 9° (15.2 %)  
Dynamic stability according to ISO 7176-2 = 9° (15.2 %)
- 4 Note: The drive range of a power wheelchair is strongly influenced by external factors, such as the speed setting of the wheelchair, the charging state of the batteries, surrounding temperature, local topography, road surface characteristics, tyre pressure, weight of user, drive style and use of batteries for lighting, servos etc.  
The specified values are theoretical maximum achievable values measured according to ISO 7176-4.
- 5 Measured without seat cushion
- 6 Distance between backrest reference plane and most forward part of armrest assembly
- 7 Legrest not removable, so no component weight measurable
- 8 The actual kerb weight depends on the fittings your power wheelchair has been supplied with. Every Invacare power wheelchair is weighed when leaving the works. Refer to the nameplate for the kerb weight (including batteries) measured.

## 12 Service

### 12.1 Inspections Performed

It is confirmed by stamp and signature that all jobs listed in the inspection schedule of the service and repair instructions have been properly performed. The list of the inspection jobs to be performed can be found in the service manual which is available through Invacare.

Delivery Inspection	1st Annual Inspection
Stamp of authorised provider / Date / Signature	Stamp of authorised provider / Date / Signature
2nd Annual Inspection	3rd Annual Inspection
Stamp of authorised provider / Date / Signature	Stamp of authorised provider / Date / Signature

4th Annual Inspection	5th Annual Inspection
Stamp of authorised provider / Date / Signature	Stamp of authorised provider / Date / Signature

**Australia:**

Invacare Australia Pty. Ltd.  
Unit 18/12 Stanton Road,  
Seven Hills, NSW 2147,  
Australia  
Phone: 1800 460 460  
Fax: 1800 814 367  
orders@invacare.com.au  
www.invacare.com.au

**EU Export:**

Invacare Poirier SAS  
Route de St Roch  
F-37230 Fondettes  
Phone: (33) (0) 2 47 62 69 80  
serviceclient\_export@invacare.com  
www.invacare.eu.com

**Canada**

Invacare Canada LP  
c/o Motion Concepts Canada  
84 Citation Drive Unit 11  
Concord, Ontario L4K 3C1

**New Zealand:**

Invacare New Zealand Ltd  
4 Westfield Place, Mt Wellington  
1060  
New Zealand  
Phone: 0800 468 222  
Fax: 0800 807 788  
sales@invacare.co.nz  
www.invacare.co.nz

**United Kingdom & Ireland:**

Invacare Limited  
Pencoed Technology Park, Pencoed  
Bridgend CF35 5AQ  
Phone: (44) (0) 1656 776 200  
uk@invacare.com  
www.invacare.co.uk



Invacare GmbH  
Am Achener Hof 8  
D-88316 Isny  
Germany



Invacare UK Operations Limited  
Unit 4, Pencoed Technology Park, Pencoed  
Bridgend CF35 5AQ  
UK

1675721-C 2024-07-11



**Making Life's Experiences Possible®**



**Yes, you can.®**