

Invacare® LiNX

DLX-REM500

en    **Remote  
User Manual**

This manual **MUST** be given to the user of the product.  
**BEFORE** using this product, this manual **MUST** be read and saved for  
future reference.



**Yes, you can.®**

---

# Contents

---

<b>1 General</b>	<b>4</b>
1.1 About This Manual	4
1.2 Symbols in This Manual	4
1.3 Warranty	5
1.4 Service Life	5
1.5 Limitation of Liability	5
1.6 General Safety Notes	5
<b>2 Components</b>	<b>7</b>
2.1 User Interface DLX-REM500	7
2.2 Screen Composition Overview	7
2.2.1 Battery Bar	7
2.2.2 Status Bar	7
2.2.3 User Function Card Overview	8
2.3 Navigation Button	11
2.4 Labels on the Product	12
<b>3 Setup</b>	<b>15</b>
3.1 General Information on Setup	15
3.1.1 Conditional Control Input / Output (Control IO)	15
3.2 Wiring	15
3.3 Connecting the Remote	16

<b>4 Usage</b>	<b>17</b>
4.1 Powering Up / Down Remote	17
4.2 Menu Screen	18
4.2.1 Controls on Menu Screen	19
4.2.2 Configuring Time	20
4.2.3 Locking Screen to Avoid Unintentional Response	20
4.2.4 Configuring Settings	21
4.2.5 Configuring Odometer	23
4.3 Selecting Functions	23
4.3.1 Function Change Inhibits	24
4.4 Using Direct Navigation	24
4.4.1 Swipe-and-Tap Mode	24
4.4.2 Tap-Only Mode	25
4.4.3 Control Input (CI)	25
4.5 Using Indirect Navigation	25
4.5.1 Quadrant Mapping	27
4.5.2 Menu Select	28
4.5.3 Navigation Entry Points in Menu Select	30
4.5.4 Menu Scan	31
4.5.5 Navigation Entry Points in Menu Scan	33
4.6 Using the Multipurpose Keys	35
4.7 Proportional / Discrete Driving Mode	35
4.7.1 Using Joystick	35
4.7.2 Controlling Maximum Speed	36
4.8 Emergency Stop	37
4.9 Latched Driving Mode	37

4.9.1	External Stop Switch	38	4.18.3	Configuring Switch Control (iOS)	68
4.9.2	1 Step Up	39	4.18.4	Operating Switch Control	69
4.9.3	3 Step Up	40	4.19	Audible Cues	70
4.9.4	5 Step Up	41	4.20	Using Secondary Inputs	73
4.9.5	3 Step Up / Down	42	4.20.1	Using Swing-Away Chin Control	74
4.9.6	5 Step Up / Down	43	4.20.2	Using Pediatric Compact Joystick	76
4.9.7	Cruise Control	44	4.20.3	Using Micro Extremity Control Joystick	76
4.10	Operating Lighting Functions and Horn	45	4.20.4	Using the Compact Single Switch Joystick	77
4.10.1	Operating the Position Lights	45	4.20.5	Using the Sip-N-Puff	77
4.10.2	Operating the Hazard Lights	46	4.20.6	Using the Sip-N-Puff Head Array	79
4.10.3	Operating the Direction Indicators	47	4.20.7	Using the Head Array	81
4.10.4	Operating the Horn	48	4.20.8	Using the Four Switch Proximity Array	83
4.11	Operating Lighting Functions and Horn via Utility Function Card	48	4.20.9	Using the Remote Stop Switch	84
4.12	Locking / Unlocking the Remote	49	4.20.10	Using the Wireless Mouse Emulator	85
4.13	Rest Mode	49	4.21	Disabling Bluetooth	87
4.14	The Sleep Mode	50	4.22	Charging the Batteries	88
4.15	Operating Powered Seating Functions	51	4.22.1	Battery alarms	89
4.15.1	Through Seating Cards	51	4.23	Using the USB charger	89
4.15.2	Through External Switches	52	<b>5</b>	<b>Maintenance</b>	<b>91</b>
4.15.3	Speed Reduction and Seating Function Inhibits	56	5.1	Replacing Mouthpiece	91
4.16	Configuring Connectivity Cards	57	5.2	Replacing Saliva Trap	91
4.16.1	Pairing LiNX System	58	5.3	Cleaning Sip-N-Puff	91
4.16.2	Linking Connectivity Card with User's Device	60	<b>6</b>	<b>Troubleshooting</b>	<b>92</b>
4.16.3	Connecting Devices with LiNX System	61	6.1	Fault Diagnosis	92
4.16.4	Removing Paired Devices	61	6.1.1	Fault Codes and Diagnosis Codes	92
4.16.5	Selecting Connectivity Card	62	6.2	OON ("Out Of Neutral")	93
4.17	Mouse Mover	63	<b>7</b>	<b>Technical Data</b>	<b>95</b>
4.17.1	Setting up a Mouse Mover	63	7.1	Technical Specifications	95
4.17.2	Operating the Mouse Mover	65			
4.18	Switch Control	66			
4.18.1	Setting up switch control	67			
4.18.2	Configuring Switch Control (Android)	67			

# 1 General

## 1.1 About This Manual

This document is a supplement to the product's user documentation.

This component itself does not bear a CE and a UKCA mark but is part of a product that complies with the Medical Device Regulation 2017/745, Class I and Part II UK MDR 2002 (as amended) Class I concerning medical devices. It is therefore covered by the product's CE and UKCA marking. See the product's user documentation for more information.

Only use this component if you have read and understood this manual. Seek additional advice from a healthcare professional who is familiar with your medical condition and clarify any questions regarding the correct use and necessary adjustment with the healthcare professional.

Note that there may be sections in this document, which are not relevant to your component, since this document applies to all available models (on the date of printing). If not otherwise stated, each section in this document refers to all models of the component.

Invacare reserves the right to alter component specifications without further notice.

Before reading this document, make sure you have the latest version. You find the latest version as a PDF on the Invacare website. Previous product versions may not be described in this Manual's current revision. If you require assistance, please contact Invacare.

If you find that the font size in the printed document is difficult to read, you can download the PDF version from the website. The PDF can then be scaled on screen to a font size that is more comfortable for you.

For more information about the component, for example safety notices and recalls, contact your Invacare representative. See addresses at the end of this document.

In case of a serious incident with the component, you should inform the manufacturer and the competent authority in your country.

## 1.2 Symbols in This Manual

Symbols and signal words are used in this manual and apply to hazards or unsafe practices which could result in personal injury or property damage. See the information below for definitions of the signal words.



### **WARNING!**

Indicates a hazardous situation that could result in serious injury or death if it is not avoided.



### **CAUTION!**

Indicates a hazardous situation that could result in minor or slight injury if it is not avoided.



### **NOTICE!**

Indicates a hazardous situation that could result in damage to property if it is not avoided.



### **Tips and Recommendations**

Gives useful tips, recommendations, and information for efficient, trouble-free use.



### **Tools**

Identifies required tools, components and items which are needed to carry out certain work.



## Other Symbols

(Not applicable for all manuals)



### UK Responsible Person

Indicates if a product is not manufactured in the UK.



### Triman

Indicates recycling and sorting rules (only relevant for France).

## 1.3 Warranty

The terms and conditions of the warranty are part of the general terms and conditions particular to the individual countries in which this product is sold.

## 1.4 Service Life

We estimate a service life of five years for this product, provided it is used in strict accordance with the intended use as set out in this document and all maintenance and service requirements are met. The estimated service life can be exceeded if the product is carefully used and properly maintained, and provided technical and scientific advances do not result in technical limitations. The service life can also be considerably reduced by extreme or incorrect usage. The fact that we estimate a service life for this product does not constitute an additional warranty.

## 1.5 Limitation of Liability

Invacare accepts no liability for damage arising from:

- Non-compliance with the user manual
- Incorrect use
- Natural wear and tear

- Incorrect assembly or set-up by the purchaser or a third party
- Technical modifications
- Unauthorised modifications and/or use of unsuitable spare parts

## 1.6 General Safety Notes



### WARNING!

#### Risk of Injury or Damage to the Power Wheelchair

Do not install, maintain or operate this equipment before you have read and understood all the instructions and all the manuals for this product and all other products that you use or install together with this product.

- Follow the instructions in the user manuals.



### WARNING!

#### Risk of Serious Injury or Damage to the Power Wheelchair or Surrounding Property

Wrong settings can make the power wheelchair uncontrollable or unstable. An uncontrolled or unstable power wheelchair can cause an unsafe situation such as a crash.

- Performance adjustments must only be made by qualified technicians or by persons who completely understand the programming parameters, the adjustment process, the configuration of the power wheelchair and the capabilities of the driver.
- Performance adjustments must only be made in dry conditions.

**WARNING!****Risk of Injury or Damage due to Electrical Shorts**

Connector pins on cables connected to the power module can still be live even when the system is off.

- Cables with live pins should be connected, restrained or covered (with non-conductive materials) so that they are not exposed to human contact or materials that could cause electrical shorts.
- When cables with live pins have to be disconnected, for example, when removing the bus cable from the remote for safety reasons, make sure to restrain or cover the pins (with non-conductive materials).

**CAUTION!****Risk of Injury from Hot Surfaces**

Remote module can get hot when exposed to strong sunlight for long periods.

- Do not leave power wheelchair in direct sunlight for long periods.

**CAUTION!****Risk of Injury due to Unintended Movement**

It is recommended that the power wheelchair, fitted with a Gyro module, has a drive function with disabled Gyro. If the power wheelchair is used in a moving vehicle (e.g. boat, bus or train) maybe the Gyro function is impaired and drive demands can result in unintended movement.

- When driving on a moving vehicle choose a drive function with disabled Gyro.
- If the power wheelchair does not have a drive function with disabled Gyro, contact your Invacare provider.

**WARNING!****Risk of Injury or Damage to the Power Wheelchair**

Risk of unintended movement of the power wheelchair or seating system when loose personal belongings (e.g. jewellery, scarfs) become entangled around the joystick.

- Make sure that any loose items are clear of the joystick when your power wheelchair is powered up.
- Power off your power wheelchair immediately to stop any movement.

**NOTICE!**

If you touch the connector pins, they can become dirty or they can be damaged by electrostatic discharge.

- Do not touch the connector pins.

**NOTICE!**

There are no user-serviceable parts inside any case.

- Do not open or disassemble any case.

## 2 Components

### 2.1 User Interface DLX-REM500

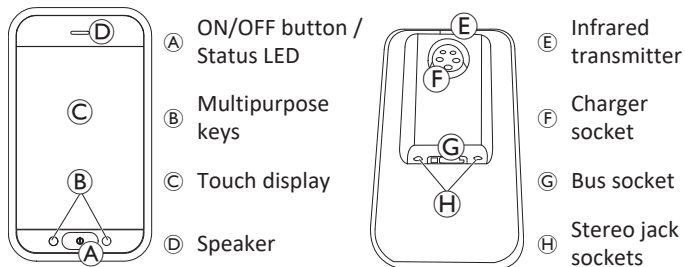

### 2.2 Screen Composition Overview

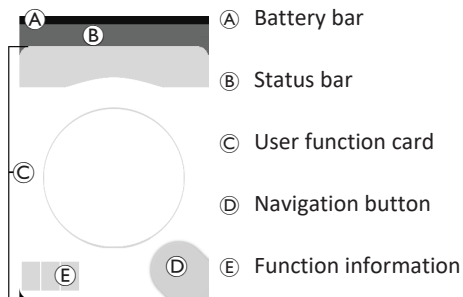

#### 2.2.1 Battery Bar

The battery bar provides a graphical display of the battery's current state of charge and, when a battery charger is connected, the charging status.



Battery bar displays green when state of charge is between 60 and 100%.



Battery bar displays orange when state of charge is between 20 and 59%.



Battery bar displays red when state of charge is less than 20%.



Charging.

#### 2.2.2 Status Bar



- (A) Profile name      (B) Time  
(C) Status information

##### Profile Name

The profile name can only be set by the provider.

##### Time

The time is displayed as a 12- or 24-hour clock. It is set using the coordinated universal time (UTC) and an offset based on the location (country) of the user. The UTC is automatically acquired when a system is connected to a programming and diagnostic tool. The country-based offset is set through the remote module's Menu screen, refer to 4.2.4 *Configuring Settings*, page 21.

## Status Information

The status information displays the current state of the LiNX system with status icons.

 This notifies you that a drive lock-out is active. A drive lock-out is a state that prevents the wheelchair being driven, refer to [4.15.3 Speed Reduction and Seating Function Inhibits](#), page 56 for more information about lock-outs and slow-downs.

 This notifies you that a drive slow-down is active. A drive slow-down is a state that prevents the wheelchair being driven at maximum speed for safety reasons. Instead, the wheelchair is allowed to drive at a reduced speed for the duration of the active drive slow-down, refer to [4.15.3 Speed Reduction and Seating Function Inhibits](#), page 56 for more information about lock-outs and slow-downs.

 This notifies you that a fault occurred. The number indicates the type of fault, refer to [6.1.1 Fault Codes and Diagnosis Codes](#), page 92 for more information about fault codes.

 This notifies you that a seating lock-out is active. A seating lock-out is a state that prevents the wheelchair's seating being operated, refer to [4.15.3 Speed Reduction and Seating Function Inhibits](#), page 56 for more information about lock-outs and slow-downs.

 This notifies you that Bluetooth connectivity is disabled, refer to [4.21 Disabling Bluetooth](#), page 87 for more information about disabling Bluetooth.

Three battery alarms are shown on the right-hand side of the status bar, refer to [4.22.1 Battery alarms](#), page 89.

## 2.2.3 User Function Card Overview

### Left- or Right-Handed

With the LiNX system, it is possible, to adjust the function cards for left-handed or right-handed users, refer to [4.2 Menu Screen](#), page 18.

Left-handed



Right-handed



Be aware, that in the following manual right-handed function cards are displayed only. All buttons have the same functions for right- and left-handed, so the descriptions can be used for left-handed users, too.

### Function Card Header









The function card type is identified by the colour of the function card's header:

- green indicates a drive card,
- orange indicates a seating card,
- blue indicates a connectivity card and
- purple indicates a utility card.



The icon **A** indicates the type of primary input.

The text **B** is programmable by your provider and can be used to name the function.

Indicator 	Type of Primary Input
	DLX-REM400 or DLX-REM500
	DLX-REM2xx or DLX-CR400 or DLX-CR400LF
	DLX-ACU200
	Input module or third-party interface
	Head Array
	Sip and Puff
	User switch

## Drive Card

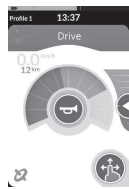



Drive cards can be pre-set with different maximum speeds to fit your needs and your environment. For example a drive card with pre-set lower maximum speed can be used for indoors and a drive card with pre-set total maximum speed for outdoors. In addition to that you can also control the pre-set maximum speed, refer to [4.7.2 Controlling Maximum Speed, page 36](#).

With a drive card you are also able to sound the horn and to operate the lighting functions, refer to [4.10 Operating Lighting Functions and Horn, page 45](#).

The speedometer / odometer feature is enabled by the manufacturer. If the manufacturer does not enable it, you do not have a speed / distance indication. If it is enabled, you can choose to display the speedometer / odometer and you can set the units to metric or imperial, refer to [4.2.4 Configuring Settings, page 21](#).

0.0 <sup>km/h</sup>	Speedometer displays standstill.
3.8 <sup>km/h</sup>	While driving, the speedometer displays the wheelchair's current speed.
12 <sup>km</sup>	The odometer displays the distance travelled by the wheelchair since it was last reset to zero or rolled over to zero. The odometer can display up to a maximum distance of 9999 km or miles, after which it rolls over to zero. At any time the odometer can be reset back to zero, refer to <a href="#">4.2.5 Configuring Odometer, page 23</a> .

The function information displays either the latched driving mode, refer to [4.9 Latched Driving Mode, page 37](#) or the Gyro indication, see table below.

no symbol	No Gyro is connected to the system or enabled for drive function.
	Gyro disabled.
	Gyro enabled.

## Seating Card



Seating cards are for operating the seating functions, refer to *4.15.1 Through Seating Cards, page 51*.

## Connectivity Card

### Mouse Mover function



### Switch Control function



Connectivity cards allow you to communicate with external devices. The connectivity functions that are supported by your remote are Mouse Mover and Switch Control. By default, these functions are disabled. Contact your provider to change the configuration.

The mouse mover allows you to control the cursor on a PC or laptop's screen with a user input on the wheelchair, such as the joystick on the remote module or an external joystick.

Switch control is an accessibility feature that allows you to navigate and select items on your iOS or Android device using the remote's joystick or touch screen.

For more information about Connectivity cards and how to use them, refer to *4.16 Configuring Connectivity Cards, page 57*, *4.17 Mouse Mover, page 63* and *4.18 Switch Control, page 66*.

## Utility Card

Utility card allows you to operate system controls (such as lighting functions and horn) as well as control outputs with external inputs. The utility card function is suitable for both three-quadrant (3Q) and four-quadrant (4Q) inputs.

*Example of a three-quadrant (3Q) navigation utility card*      *Example of a four-quadrant (4Q) navigation utility card*

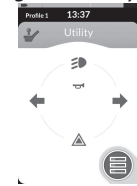

Utility card allows you to operate two controls / outputs per quadrant, according to the duration that the user input is activated:

- A Short press / Momentary press, and
- B Long press.



















By default, this function is only enabled for chair configurations with an external control input that will not allow the control of horn or lights. Contact your provider to change the configuration and to set up your desired operations.

For an example how to use an utility card in daily use, refer to [4.11 Operating Lighting Functions and Horn via Utility Function Card, page 48](#).

### Arrangement

User function cards are arranged in rows of profiles. Each profile can hold user function cards, which can be of the same type, for example all drive cards, or can be a mixture of drive, seating and connectivity cards.

The maximum number of function cards across all profiles is 40. In a configuration with five profiles, for example, each profile can hold up to eight function cards.

	Function Cards					
	F1	F2	F3	F4	F5	F6
Profiles	P1					
	P2					
	P3					
	P4					

## 2.3 Navigation Button

Depending on the configuration of the remote module and the user's needs, the navigation button is displayed bottom-left or bottom-right on the screen.

When activated, navigation button colour changes from grey to blue. The navigation button has two important functions:

1. A visual indication of the configured interaction mode.



Configured for swipe-and-tap actions  
This means, that swiping and tapping the screen activates different functions.



Configured for tap actions  
This means, that only tapping the screen activates different functions. Swipe inputs are ignored.



For more information about changing the interaction mode, refer to [4.2.4 Configuring Settings, page 21](#).

2. A navigation function depending on context and activation duration. For example, a short press on the navigation button, while viewing an active user function card, opens the card preview display, refer to [4.3 Selecting Functions, page 23](#). A long press opens the status screen, refer to [4.2.4 Configuring Settings, page 21](#).

Additional to the touch display, external inputs can be used to interact with the system, refer to [4.20 Using Secondary Inputs, page 73](#).

## 2.4 Labels on the Product

### Labels on Dynamic Controls' Parts

Labels of Dynamic Controls' parts are located on rear side of the part. Depending on the part not all labels are available.

Rear side of DLX-IN500 input module

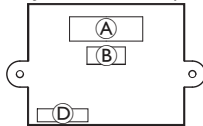

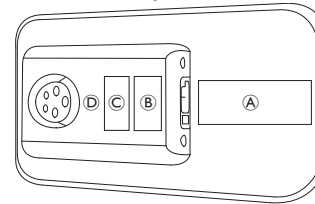

Rear side of DLX-REM500



<p>Ⓐ</p>	<p>The logo features the text 'dynamiccontrols.com' and 'dynamiccontrols' with a stylized 'd' logo. Eight numbered arrows point to specific elements: 1 points to the top left corner, 2 to the bottom right corner, 3 to the top right corner, 4 to the bottom left corner, 5 to the top left corner, 6 to the top right corner, 7 to the bottom right corner, and 8 to the bottom left corner.</p>	<p>Product label containing:</p> <ol style="list-style-type: none"> <li>1. Part number</li> <li>2. Dynamic Controls logo</li> <li>3. Dynamic Controls' part description</li> <li>4. Dynamic Controls' website address</li> </ol>	<ol style="list-style-type: none"> <li>5. Serial number</li> <li>6. Warning to read manual before use</li> <li>7. Ingress protection rating</li> <li>8. WEEE symbol</li> </ol>
<p>Ⓑ</p>	<p>A dark rectangular label with white text. It contains 'H02 008' and 'S00 003'. Six numbered arrows point to specific elements: 1 points to the top left, 2 to the top right, 3 to the top right, 4 to the bottom left, 5 to the bottom left, and 6 to the bottom right.</p>	<p>Hardware and application firmware version label:</p> <ol style="list-style-type: none"> <li>1. Hardware version</li> <li>2. Hardware major version</li> </ol>	<ol style="list-style-type: none"> <li>3. Hardware minor version</li> <li>4. Application version</li> <li>5. Application major version</li> <li>6. Application minor version</li> </ol>
<p>Ⓒ</p>	<p>A dark rectangular label with white text. It contains 'www.dynamiccontrols.com', 'Contact:ns', and 'FCC ID: P4/BTM605'.</p>	<p>Product label containing:</p> <ul style="list-style-type: none"> <li>• Dynamic Controls' website address</li> </ul>	<ul style="list-style-type: none"> <li>• Dynamic Controls' Bluetooth registration</li> </ul>
<p>Ⓓ</p>	<p>A black rectangular label with white text that reads 'WARRANTY VOID IF SEAL IS BROKEN'.</p>	<p>Tamper evident seal.</p>	



## Explanation of Symbols on Labels

	<p>This is the WEEE symbol (Waste Electrical and Electronic Equipment Directive). This product has been supplied from an environmentally aware manufacturer. This product may contain substances that could be harmful to the environment if disposed of in places (landfills) that are not appropriate according to legislation.</p> <ul style="list-style-type: none"> <li>• The 'crossed out wheeled bin' symbol is placed on this product to encourage you to recycle wherever possible.</li> <li>• Please be environmentally responsible and recycle this product through your recycling facility at its end of life</li> </ul>
IPX4	This is the enclosure's ingress protection rating.
	Recommendation to read the instruction manual before using the module.

## Serial Number and Date of Manufacture

The serial number on a Dynamic Controls product provides both the date of manufacture as well as a unique serial number for the particular module.

S/N: A14132800

The format is **MYnnnnnn**, where:

- **M** is for the month of manufacture, using the letters A to L (A = Jan, B = Feb, C = Mar, etc.),
- **YY** is the year of manufacture,
- **nnnnnn** is a unique six digit sequential number.

For example, the remote's serial number, as shown above, begins with A14 indicating that it was manufactured in January 2014, and its unique, sequential value is 132800.

### Labels on Adaptive Switch Labs' Parts

Labels of Adaptive Switch Labs' parts are located either on left rear side of the part (head arrays) or the interface box. Depending on the used part not all labels are available.

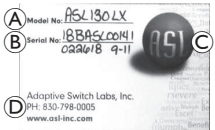
	<p>Product label (head array) containing:</p> <ul style="list-style-type: none"> <li>• (A): Adaptive Switch Labs' logo</li> <li>• (B): Serial number</li> </ul>	<div style="border: 1px solid black; padding: 5px; font-size: small;"> <p>Contains FCC ID: A8TBM1152                  This device complies with Part 15 of the FCC Rules. Operation is subject to the following 2 conditions:                  (1) this device must accept any interference received,                  (2) this device must accept any interferences that may cause undesired operation.</p> </div>	<p>Product label containing:</p> <ul style="list-style-type: none"> <li>• Adaptive Switch Labs' Bluetooth registration</li> <li>• Information about conditions</li> </ul>
	<p>Product label (interface boxes) containing:</p> <ul style="list-style-type: none"> <li>• (A): Model number</li> <li>• (B): Serial number</li> <li>• (C): Adaptive Switch Labs' logo</li> <li>• (D): Adaptive Switch Labs' contact information</li> </ul>		

## 3 Setup

### 3.1 General Information on Setup

The tasks described in this chapter are intended to be performed by trained and authorised service technicians for initial setup. They are not intended to be performed by the user.

#### 3.1.1 Conditional Control Input / Output (Control IO)

The individual programming of the wheelchair with one of the LiNX Access Tools must be made by a qualified technician.

The LiNX system now supports conditional control IO, extending the current always rule-based model, where a single output action is always activated in response to a single input action. With the introduction of conditional control IO, a qualified technician can now create:

- multiple always rules — one or more outputs are always activated from a single input,
- conditional rules — one or more outputs are activated from a single input if the specified conditions are true,
- conditional/else rules — an output is activated from a single input if a specified condition is true, else (otherwise) an alternative output is activated if the same specified condition is false.

The benefit of conditional IO is two-fold. Firstly, a single input can now activate multiple outputs. Secondly, control inputs can be overloaded. Overloading is where a single input can have multiple uses, each of which depends on specified conditions.

This means that an input can be used to activate one output if the system is in one state or function, and then activate a different output when the system is in another state or function. For example, a buddy button that is used to stop a wheelchair when driving can also be used to extend a seating motion when in a seating function.

### 3.2 Wiring

For safe and reliable operation, the installation of looms and cables must follow the basic principles of power wiring.

Cables must be secured between their connectors and any point of flexing so that flexing forces are not transferred to the connectors.



#### CAUTION!

##### Risk of Injury and Damage to the Remote

Damage to cables increases wiring impedance. A damaged cable can potentially produce localised heat, sparks or arcing and become a source of ignition to surrounding flammable material.

- The installation must ensure that all power cables, including the bus cable, are protected against damage and potential contact with flammable materials.



#### NOTICE!

Cables and remote modules can get damaged if not positioned properly.

- Route and position cables and remote modules so that they are free from physical strain, abuse or damage, such as snagging, crushing, impacts from external objects, pinching or abrasion.

Adequate strain relief must be provided for all cables, and the mechanical limits of the cables and looms must not be exceeded.

Ensure that connectors and connector sockets are shielded from water splashes and water ingress. Cables with female connectors should face horizontally or downwards. Ensure all connectors are fully mated.



**CAUTION!**

**Risk of Injury and Damage to the Remote**

Connector pins on cables connected to the power module can still be live even when the system is off.

- Cables with live pins should be connected, restrained or covered so that they are not exposed to human contact or materials that could cause electrical shorts.

Make sure that the cables do not extend beyond the wheelchair to prevent them from being caught or damaged by external objects. Take particular care on wheelchairs with movable structures such as a seat lifter.



**WARNING!**

**Risk of Injury or Damage due to Electrical Shorts**

Continuous contact between user and cable can result in frayed cable jacket. This increases risk of electric shorts.

- Avoid routing the cable where it will come into continuous contact with the end user.

When installing the bus cable, avoid undue straining of the cable and connection points. Flexing of the cable should be minimised wherever possible, to extend service life and minimize the risk of accidental damage.



**NOTICE!**

Regular bending can damage bus cable

- Use of a cable chain to support the bus cable, where the cable is subject to regular cyclic bending, is recommended. The maximum stretch of the chain should be less than the length of the bus cable. The force applied to flex the cable should never exceed 10 N.



Appropriate life testing should be carried out to determine / confirm the expected service life and inspection and maintenance schedule.

### 3.3 Connecting the Remote



**CAUTION!**

**Risk of Unintended Stops**

If the plug of the remote cable is damaged, the remote cable may come loose while driving. The remote may lose power, could suddenly power down and force an unintended stop.

- Always check the plug of the remote for damage.  
Contact your provider immediately in case of a damage.



**NOTICE!**

The remote plug and connector socket fit together in one way only.

- Do not force them together.

1. Lightly push to connect the plug of the remote cable and the connector socket with an audible click.

## 4 Usage

### 4.1 Powering Up / Down Remote

#### Powering Up Remote

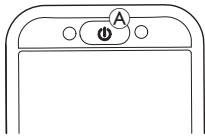

1. Press ON/OFF key (A).



2. Start screen lights up.

The status LED inside the ON/OFF key lights up green, if no fault is present at power up. After a few seconds display is ready to use. If there is a fault with the system when powering up, the status LED indicates the fault with a series of red flashes, also a fault icon is displayed in the status bar. For more information about fault indication, refer to *6.1.1 Fault Codes and Diagnosis Codes, page 92*.

#### Powering Down Remote



1. Press ON/OFF key (A).  
Shut down screen is displayed.  
After a few seconds the remote is powered down.

#### Attendant in Charge

If your wheelchair is fitted with an attendant control (DLX-ACU200) and the attendant control is in charge, an attendant-in-charge-overlay is displayed. Also the status LED inside the ON/OFF key of the primary remote is turned off.

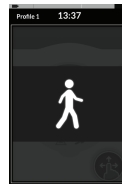

1. Press ON/OFF key (A) of primary remote to take over control.

Attendant control powers down automatically.



For more information about using the attendant control, refer to the manual of the attendant control.

## 4.2 Menu Screen

### Opening Menu Screen

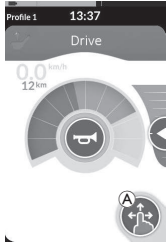

1. Tap and hold navigation button **A** until Menu screen appears.

### Closing Menu Screen

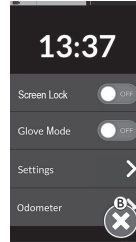

1. Tap on button **B** to close Menu screen.

### Configuring Menu Screen

The remote can be configured from Menu screen. Menu screen offers different settings.

		Entry	Function
	<b>A</b>	Clock	View and configure time, refer to <i>4.2.2 Configuring Time, page 20</i> .
	<b>B</b>	Screen Lock	Activate screen lock, refer to <i>4.2.3 Locking Screen to Avoid Unintentional Response, page 20</i> .
	<b>C</b>	Glove Mode	Activate Glove Mode. Touch screen becomes more sensitive, allowing to interact with screen while wearing gloves.
	<b>D</b>	Settings	Open settings menu. For configuring settings, refer to <i>4.2.4 Configuring Settings, page 21</i> .
	<b>E</b>	Odometer	View total travel, reset odometer, select units, refer to <i>4.2.5 Configuring Odometer, page 23</i> .

### 4.2.1 Controls on Menu Screen

#### Buttons





Buttons are used to perform an action, such as  to close the screen.

##### Example of a button



1. Tap on button  to perform the action.

Currently the following buttons are used on the remote display:

Symbol	Action	Symbol	Action
	Close screen.		Open next screen / level. It appears only if a menu entry permit further settings.
	Go back to previous screen.		Increase or decrease the value of hour or minute on clock.

#### Switches

Switches are used to change between two different states, such as **ON** and **OFF**. The current state is visible on screen.

##### Example of a switch





1. Tap on switch  to change the state.

#### Sliders

Sliders are used to change value of a setting continuously.

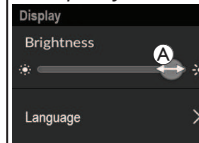
##### Example of a slider



1. Tap and hold circle  within the slider.
2. Swipe circle to the right to increase the value. Swipe circle to the left to decrease the value.

### 4.2.2 Configuring Time

1. Tap on clock to edit time. In Time Edit mode, clock displays time picker where hour and minute values can be changed independently.

2. Tap on arrows **A** to adjust hour value or **B** to adjust minute value.

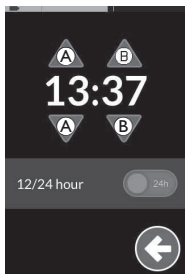

3. If necessary, tab switch **C** to toggle between 12- and 24-hour clock.

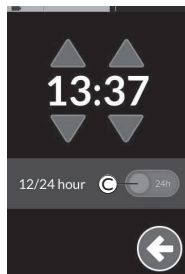

24-hour clock



12-hour clock



4. Tap on button **D** to return to Menu screen.

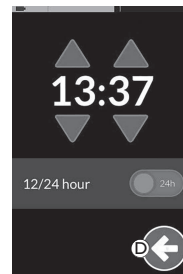

### 4.2.3 Locking Screen to Avoid Unintentional Response

The screen lock is a security feature that the user can activate to prevent other people accidentally or intentionally interfering with the touch screen. It also prevents any unintentional response caused by rain or other liquids that may land on the touch screen.

When the screen lock is activated, the screen continues to display normally but it does not respond to any swipe or tap action.

1. Tap and hold navigation button **A** to open Menu screen.



2. Tap on Screen Lock switch **B** to lock screen.



3. Tap on button **C** to close Menu screen. Screen lock is activated.

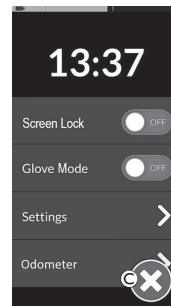

Turn remote off and on (power-cycle) to deactivate screen lock. Keep the touch screen dry to ensure proper response during use.



## 4.2.4 Configuring Settings

Settings menu allows you to change settings in different categories:

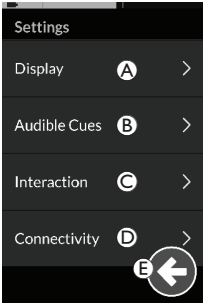
		Entry	Function
	Ⓐ	Display	Open display settings.
	Ⓑ	Audible Cues	Open audible cues settings.
	Ⓒ	Interaction	Open interaction settings.
	Ⓓ	Connectivity	Open connectivity settings.
	Ⓔ	Back	Go back to the previous level.

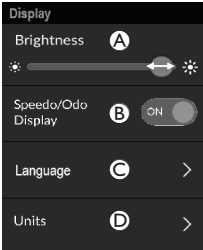

### Display

		Entry	Function
	Ⓐ	Brightness	Decrease or increase screen brightness.
	Ⓑ	Speedo / Odo Display	Enable speedometer / odometer information on drive cards.
	Ⓒ	Language	Change user interface of Menu screen to selected language.
	Ⓓ	Units	Select units.

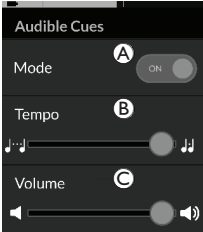
**Audible Cues** (For more information about audible cues, refer to *4.19 Audible Cues, page 70.*)

		Entry	Function
	Ⓐ	Mode	Select On to enable audible cues and Off to disable audible cues.
	Ⓑ	Tempo (optional)	Adjust speed at which audible cues are played. Slowest speed is to the left, fastest to the right.
	Ⓒ	Volume	Set volume of audible cues. On REM500 two volume settings are displayed, one for front and one for rear speaker.

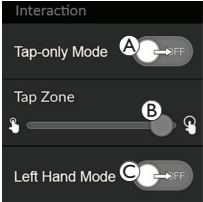
**Interaction**

		Entry	Function
	Ⓐ	Tap-Only Mode	Toggle between tap-only mode and swipe-and-tap mode.
	Ⓑ	Tap Zone	<p>Defines the area used for detecting a tap action on touch screen. It sets the area around the point of initial contact, within a tap is recognised. Outside this area, further, continuous contact will be considered as a drag / swipe.</p> <p>Recommendation:</p> <ul style="list-style-type: none"> <li>• Good dexterity → Low value (small tap zone)</li> <li>• Poor dexterity → High value (large tap zone)</li> </ul> <p> This parameter does not change the area around fixed inputs (buttons, links, etc.). It is solely for the area around the first point of contact when tapping or swiping.</p>
	Ⓒ	Left Hand Mode	Toggle between right-hand and left-hand usage of remote. When the switch is set to <b>ON</b> , all user controls (navigation button, speed slider, lighting controls etc) are displayed and operable from the left-hand side of the screen.

**Connectivity** For more information about connectivity settings, refer to *4.16 Configuring Connectivity Cards, page 57.*

## 4.2.5 Configuring Odometer

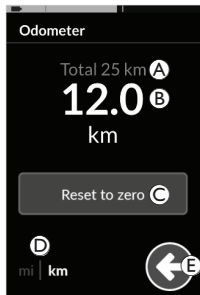

- Ⓐ Total distance meter
- Ⓑ Trip meter
- Ⓒ Reset button
- Ⓓ Units selector
- Ⓔ Back

The total distance meter shows the cumulative value of all trips.



The total distance meter cannot be reset from this screen. Contact your provider to reset this value.

The trip meter displays the current trip value. This is the value that is displayed on the drive cards.

### Resetting Odometer



Tap and hold navigation button Ⓐ to open Menu screen.

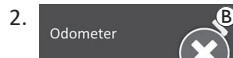

Tap on **Odometer** button.

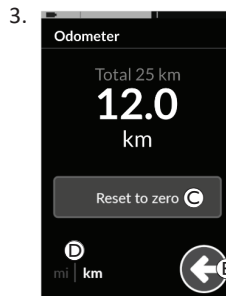

Tap on **Reset to zero** Ⓒ to reset trip value.

### Changing Units

Tap on units selector Ⓓ to change displayed units. **mi** for miles, **km** for kilometres. Tap on button Ⓔ to go back to Menu screen.



The units can also be set through the display configuration settings, refer to [4.2.4 Configuring Settings, page 21](#).

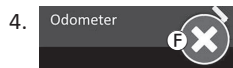

Tap on button Ⓕ to close Menu screen.

## 4.3 Selecting Functions

You can locate and select a function card by navigating through the programmed profiles and functions. There are different ways of navigation that can be used, depending on your needs and abilities. These methods fall into two groups:

- direct navigation and
- indirect navigation.

How to navigate through the LiNX system depends on how the navigation button is configured. Refer to [2.3 Navigation Button, page 11](#), for more information about the possible configurations.

### 4.3.1 Function Change Inhibits



Function change blocked is a safety feature that prevents accidental driving or seating movements, when:

- a function change should be carried out during the user performs an action on the active function.



The user must finish his current action to change the function. Otherwise a function change blocked overlay is displayed.

## 4.4 Using Direct Navigation

Direct navigation allows you to select a function by traversing the system's profiles and functions using the touch screen or other programmed switches attached to control inputs. There are different direct navigation methods available:

- swipe-and-tap mode,
- tap-only mode and
- control inputs (CI).



With each method you navigate through profiles and functions by moving from an active function card to an adjacent function card.







Direct navigation is not performed with an active user input (e.g. remote), since the active user input is used to operate the active function card only (e.g. moving the remote to drive). Instead, the user navigates through the profiles and functions using the touch screen or other control inputs.

### 4.4.1 Swipe-and-Tap Mode

#### Changing Function Cards

1.  Swipe over screen or tap navigation button to open card preview display.
2.  Swipe left or right to change function cards.
3. Tap on selected function card, tap navigation button or wait for a few seconds to activate selected function card.

#### Changing Profiles

1. Profile 1 
  - ↓
  - Profile 2  Swipe up or down to activate another profile. The screen view focuses on the first function card or the last-used function card in the profile, depending on how the programming is set up.
  - ↓
  - Profile 3 
    - ↓
    - Profile 4 
2. Swipe left or right to change function cards.
3. Tap on selected function card, tap navigation button or wait for a few seconds to activate selected function card.

### 4.4.2 Tap-Only Mode

#### Changing Function Cards

- 

Tap on navigation button (short press) to open card preview display.
- 

Tap to left or right of card that is in the middle of display to change function cards.
- Tap on selected function card, tap navigation button or wait for a few seconds to activate selected function card.

#### Changing Profiles

- Profile 1



Tap above or below function card that is in the middle of display to activate another profile.

Profile 2



The screen view focuses on the first function card or the last-used function card in the profile depending on how the programming is set up.

Profile 3



Profile 4

- Tap on navigation button or wait for a few seconds to activate selected function card.

### 4.4.3 Control Input (CI)

A control input can be any external switch, for example, an egg switch or a lip switch at a Sip and Puff Array.

- Short press to change function card.
- Long press to change profile.

No card preview is displayed. The function cards change and become active immediately.

## 4.5 Using Indirect Navigation

Indirect navigation is the ability to navigate through different profiles and function cards, independently from the touch display, with the help of the active user input (for example, a Head Array).

By default, the indirect navigation is disabled. Contact your provider, if indirect navigation should be enabled.

There are different indirect navigation methods:

- menu select (using list or grid view)
- menu scan (using list or grid view)

#### List View



List view presents the menu items in one or two vertically selectable lists, where one list presents the profiles and the next list presents the selected profile's functions. When a menu item becomes selectable, its background is highlighted blue.

## Grid View



Grid view presents the menu items in a single grid, displaying both the profiles (rows) and the functions (columns) at the same time. Unlike list view, where navigation is restricted to the vertical direction, grid view permits both vertical and horizontal directions, simplifying the transition between profiles and functions. When a menu item becomes selectable, its background is highlighted blue.



Grid view can only show a limited number of profiles and functions at any one time. Further functions and profiles can be revealed, if available, by navigating down for profiles and right for functions.

## Navigation Entry

By default the indirect navigation is entered via a control input (CI), for example, an egg switch.

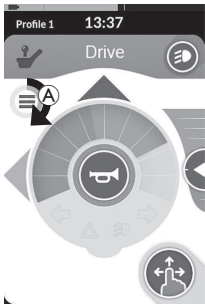

If **Navigation Timeout** is enabled by your provider, the indirect navigation is automatically entered after a period of time without user activity. This period can be set by your provider and is displayed with a timeout indicator (A).



Last / first function



no wrap



Navigating through function cards can be set up so that the navigation menu is entered instead of function card wrapping when at the end of the profile. This behaviour must be enabled by your provider.



That is when selecting the next function card while in the last function card in a profile or when selecting the previous function card when in the first function card of the profile, instead of wrapping to the next / previous function, the navigation menu is entered.

### 4.5.1 Quadrant Mapping

Similar to the drive function, there is a difference between a three-quadrant (3Q) and a four-quadrant (4Q) operation.

	4Q: Joystick, Sip and Puff, Sip and Puff Head Array	3Q: Head Array (no forward input), Four Switch Proximity Array
<b>Menu select: List view</b>	<ul style="list-style-type: none"> <li>• left: back to previous menu</li> <li>• right: select</li> <li>• reverse: menu item below</li> <li>• forward: menu item above</li> </ul>	<ul style="list-style-type: none"> <li>• left: select</li> <li>• right: menu item below</li> <li>• reverse: disabled</li> <li>• forward: disabled</li> </ul>
<b>Menu select: Grid view</b>	<ul style="list-style-type: none"> <li>• short left: function left</li> <li>• long left: exit menu</li> <li>• short right: function right</li> <li>• long right: select</li> <li>• reverse: profile below</li> <li>• forward: profile above</li> </ul>	<ul style="list-style-type: none"> <li>• short left: select</li> <li>• long left: exit menu</li> <li>• short right: function right</li> <li>• long right: profile below</li> <li>• reverse: disabled</li> <li>• forward: disabled</li> </ul>
<b>Menu scan: List view</b>	<ul style="list-style-type: none"> <li>• left: select</li> <li>• right: select</li> <li>• reverse: select</li> <li>• forward: select</li> </ul>	<ul style="list-style-type: none"> <li>• left: select</li> <li>• right: select</li> <li>• reverse: disabled</li> <li>• forward: disabled</li> </ul>
<b>Menu scan: Grid view</b>	<ul style="list-style-type: none"> <li>• left: select</li> <li>• right: select</li> <li>• reverse: select</li> <li>• forward: select</li> </ul>	<ul style="list-style-type: none"> <li>• left: select</li> <li>• right: select</li> <li>• reverse: disabled</li> <li>• forward: disabled</li> </ul>

## 4.5.2 Menu Select

With menu select, you perform both, the navigation and the function card selection.

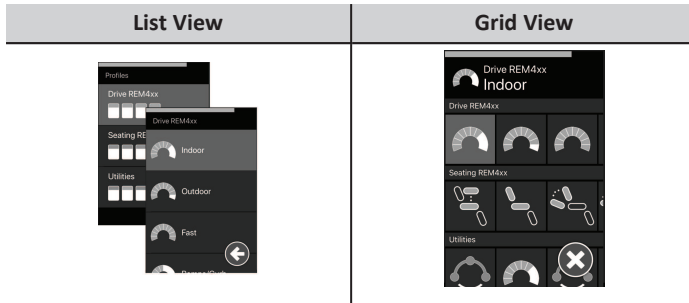

### 4Q Operation in List View

1. Enter navigation.

2.

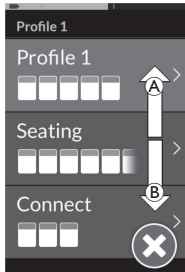

Give forward demand **A** or reverse demand **B** to switch between profiles.

3.

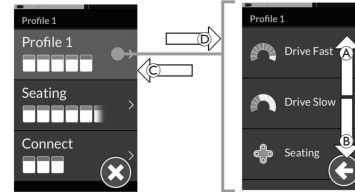

Give right demand **D** to select profile.  
Function card menu opens.

Give forward demand **A** or reverse demand **B** to switch between function cards.

Give left demand **C** to switch back to previous menu.

4.

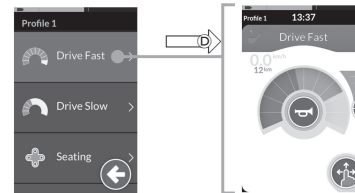

Give right demand **D** to select function card.

### 3Q Operation in List View

1. Enter navigation.

2.

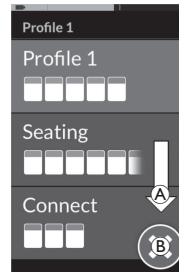

Give right demand **A** to change profile.

To close profile menu, give right demand until Close button **B** is selected.  
Give left demand to close profile menu.



3.

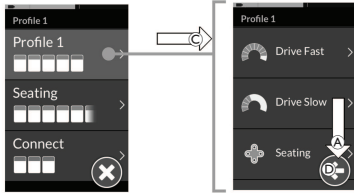

Give left demand **C** to select profile.  
Give right demand **A** to change function card.

4. To go back to profile menu, give right demand until Back button **D** is selected.

Give left demand to go back to profile menu.

5.

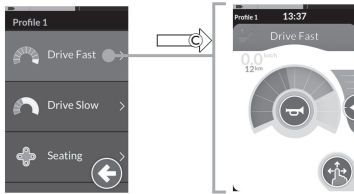

Give left demand **C** to select function card.

### 4Q Operation in Grid View

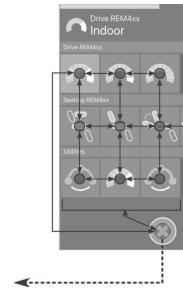

1. Enter navigation.
2. Give demand to navigate through profiles and functions.
  - a. Give short left or short right demand to navigate horizontally.
  - b. Give forward or reverse demand to navigate vertically.
3. Give long right demand to select function.
4. Give long left demand to exit navigation.

### 3Q Operation in Grid View

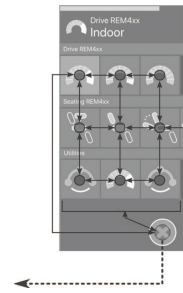

1. Enter navigation.
2. Give demand to navigate through profiles and functions.
 

In 3Q operation you can navigate in one direction horizontally and one direction vertically.

  - a. Give short right demand to navigate horizontally to next function.
  - b. Give long right demand to navigate vertically to profile below.
3. Give short left demand to select function.
4. Give long left demand to exit navigation.

### 4.5.3 Navigation Entry Points in Menu Select

#### List View

NEP = Navigation Entry Point

FC = Function Card

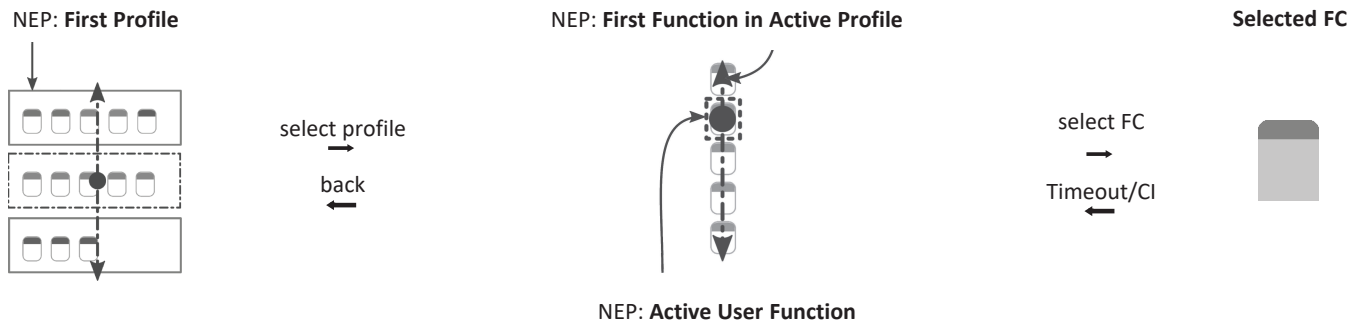

There are different navigation entry points:

- If the Navigation entry is set to **First Profile**, the menu selection starts at the first profile in the profile menu. You select a profile, before moving into the selected profile's function card menu. You can then either select a function card from the function card menu or return to the profile menu to select a different profile.
- If Navigation entry is set to **Active User Function**, the menu selection starts at the currently selected function card in the function card menu. From here you can choose to navigate the function card menu, select a function card or move up into the profile menu and select a different profile.
- If Navigation entry is set to **First Function in Active Profile**, the menu selection starts at the first function in the currently selected profile. From here you can choose to navigate the function card menu, select a function card or move up into the profile menu and select a different profile.

## Grid View

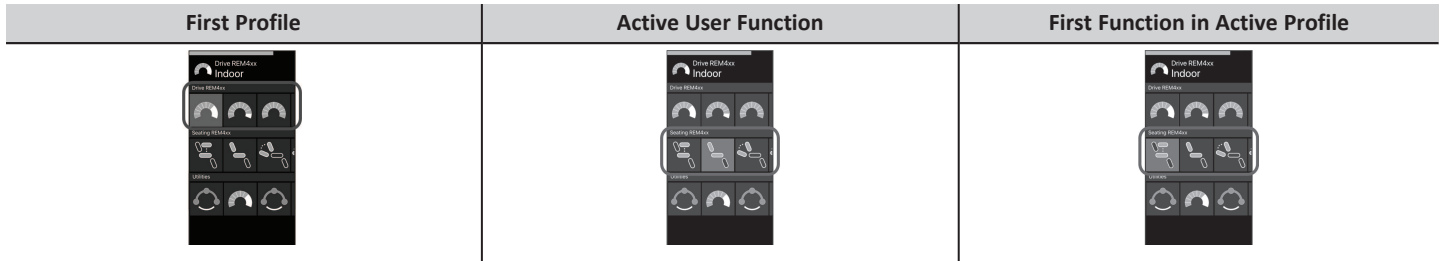

There are different navigation entry points:

- If Navigation entry is set to **First Profile**, the menu selection starts at the first function in the first profile. From here you can choose to navigate between functions and profiles before selecting a function.
- If Navigation entry is set to **Active User Function**, the menu selection starts at the currently selected function. From here you can choose to navigate between functions and profiles before selecting a function.
- If Navigation entry is set to **First Function in Active Profile**, the menu selection starts at the first function in the currently selected profile. From here you can choose to navigate between functions and profiles before selecting a function.

### 4.5.4 Menu Scan

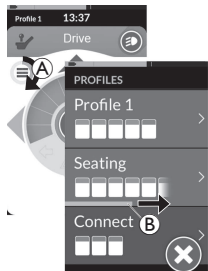

With menu scan, the system performs the navigation and you select the function card. Menu scan provides you with a semi-automated process for navigating through the profiles and function card menus by displaying you one menu item (or navigation control) at a time. For each menu item displayed, you can choose to select it or ignore it. If ignored, the next menu item is displayed on the touch screen after a small period of time. The period is set by the provider.

The period of time before the next item is displayed, is shown by an indicator ring (A) or an indicator bar (B).



Each menu is iterated a set number of times. This number is set by your provider. If no selection is made when the set number of iterations is reached, the system enters an idle state, displayed by the overlay above.

The system can enter the idle state from either the profile menu or the function card menu. To exit the idle state, you must provide a select demand. When exiting the idle state, the system returns to the profile or function menu depending on the Navigation entry setting. For more information about the Navigation entry, refer to *4.5.5 Navigation Entry Points in Menu Scan*, page 33.

## Operation in List View

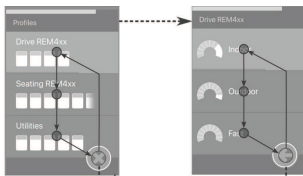

For menu scan in list view, menu items are displayed in one of two lists: profiles or functions. When viewing either list, the system navigates automatically through the menu items, moving from top to bottom, highlighting one menu item at a time for a short duration. The duration between highlighting menu items is set by the provider.

Whenever a menu item is highlighted, you can choose to select or ignore it. If ignored, the next menu item below is highlighted after a short duration. To move from the profile list to the function list, you must select a highlighted profile.

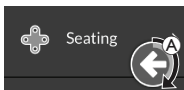

When in profile list, the exit button is highlighted after highlighting the last profile in the list. When in the function list, the back button is highlighted after highlighting the last function in the list.

1. Give select demand, if control navigation item  is displayed.

## Operation in Grid View



For menu scan in grid view, menu items are displayed in one single grid, showing profiles and functions at the same time. The system navigates automatically through the menu items, moving left to right when in a profile, and from top to bottom, through the profiles when no profile is selected.

Whenever a menu item (profile or function) is highlighted, you can choose to select it or ignore it. If a highlighted profile is ignored, the next profile below it is highlighted. If a highlighted function is ignored, the next function to the right is highlighted after a short duration. The duration between highlighting menu items is set by the provider.

If all functions are ignored in a profile, the system reverts to highlighting profiles only. After highlighting the final profile, the exit button is highlighted.

### 4.5.5 Navigation Entry Points in Menu Scan

Navigation Entry Point = NEP

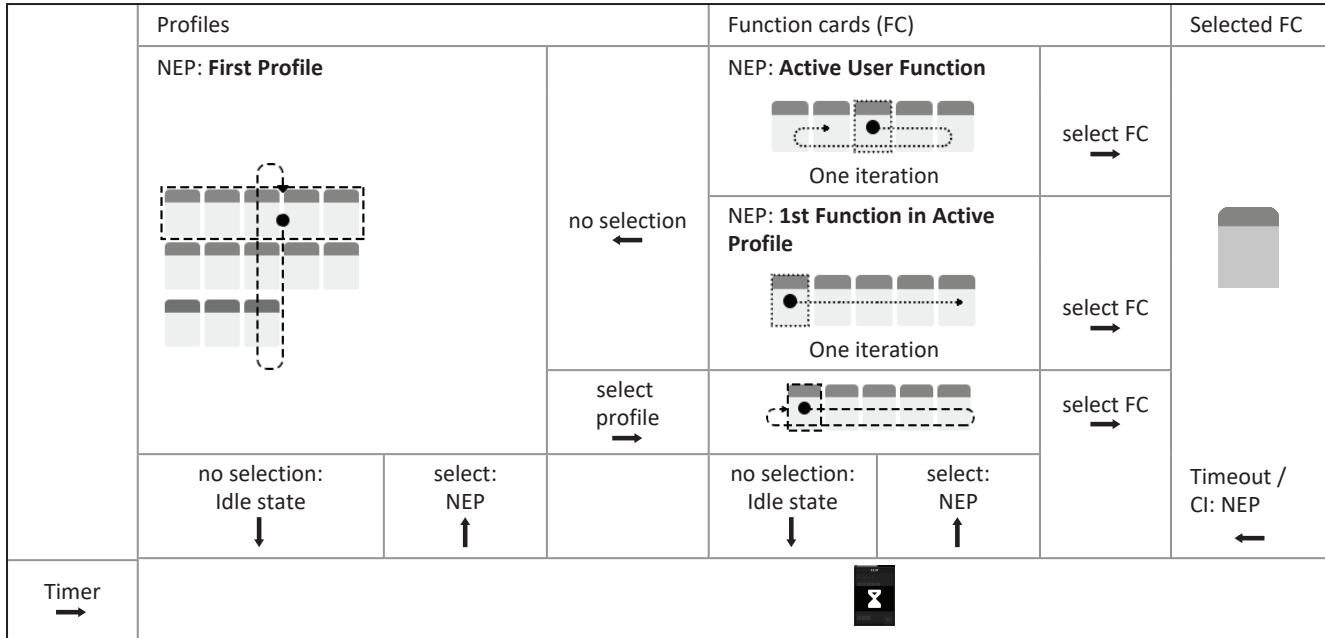

## Navigation Entry Points

There are different navigation entry points:

- If Navigation entry is set to **First Profile**, the first item in the profile menu is displayed on the touch screen. If this item is not selected, the system iterates through the profile menu until a profile is selected or until the number of iterations is reached, at which point the system displays the idle state. If a profile is selected before the system goes into the idle state, the system displays the first item in the function card menu. If this item is not selected, the system iterates through the function card menu until a function card is selected or until the number of iterations is reached, at which point the system displays the idle state.
- If Navigation entry is set to **Active User Function**, the currently selected function card item is displayed on the touch screen. If this function card is not selected, the system iterates once through the remaining function card items in the profile, wrapping around from the last menu item to the first, if necessary. During this single iteration, a function card must be selected, otherwise the system reverts to the profile menu. If the system reverts to the profile menu, the first item in the profile menu is displayed on the touch screen. If this item is not selected, the system iterates through the profile menu until a profile is selected or until the number of iterations is reached, at which point the system displays the idle state. If a profile is selected before the system goes into idle state, the system displays the first item in the function card menu. If this item is not selected, the system iterates through the function card menu until a function card is selected or until the number of iterations is reached, at which point the system displays the idle state.
- If Navigation entry is set to **First Function in Active Profile**, the first function card item in the currently selected profile is displayed on the touch screen. If this function card is not selected, then the system iterates once through the remaining function card items in the profile. During this single iteration, a function card must be selected, otherwise the system reverts to the profile menu. If the system reverts to the profile menu, the first item in the profile menu is displayed on the touch screen. If this item is not selected, the system iterates through the profile menu until a profile is selected or until the number of iterations is reached, at which point the system displays the idle state. If a profile is selected before the system goes into idle state, the system displays the first item in the function card menu. If this item is not selected, the system iterates through the function card menu until a function card is selected or until the number of iterations is reached, at which point the system displays the idle state.

## 4.6 Using the Multipurpose Keys

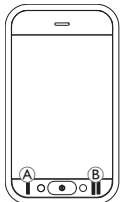

By default, you can change profiles and function cards with the multipurpose keys.

1. Press left key **A** to switch to next profile.
2. Press right key **B** to switch to next function card.

## 4.7 Proportional / Discrete Driving Mode

### 4.7.1 Using Joystick

The DLX-REM500 itself is a touch display only and does not include a joystick. Drive movements are performed by external inputs.



The following explanation is only for external inputs, that include a joystick. For information about using external inputs without joystick, like a Head Array, refer to [4.20 Using Secondary Inputs](#), page 73.

The external joystick controls the direction and the speed of the wheelchair.

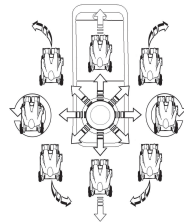

When the external joystick is deflected from the neutral (center) position, the wheelchair moves in the direction of the external joystick movement.

If the external joystick is released from any position other than the neutral position, the external joystick returns to the neutral position and the wheelchair slows down and stops. The external joystick can also be used to wake up the system when in sleep mode, if this parameter has been enabled by the provider, refer to [4.14 The Sleep Mode](#), page 50.

### Proportional Driving Mode

The speed of the wheelchair is proportional to the external joystick deflections, so that the further the external joystick is moved from the neutral position, the faster the wheelchair travels.

If the external joystick is moved back to the neutral position, the wheelchair slows down and stops.

If it is too difficult to fully deflect the external joystick in all directions, your provider can change the joystick shaping. Joystick shaping is used to reduce the extent the external joystick has to be deflected to reach full demand in one or more quadrants. With joystick shaping, each quadrant can be configured individually.

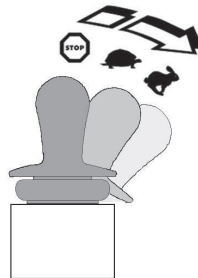

## Discrete Driving Mode

The speed of the wheelchair is pre-set by controlling the maximum speed, refer to 4.7.2 *Controlling Maximum Speed*, page 36.

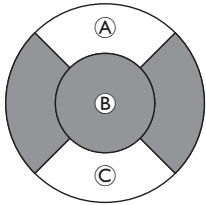

The speed is activated when the external joystick is deflected past a configurable threshold **B** into either the forward **A** or backward **C** quadrant and reaches the pre-set maximum speed without any further deflection. The Joystick Switch Threshold can be set by your provider. If the external joystick is moved back to the neutral position, the wheelchair slows down and stops.

## 4.7.2 Controlling Maximum Speed

The speed dial is divided into ten segments, representing the speed range of the wheelchair. Each segment can be displayed in one of three colours.



- The green section **A** displays the speed range, determined by the set point **E** on the speed slider **D**.
- The yellow section **B** displays the pre-set maximum speed range **C**, depending on the programming of the drive card.
- The grey section **F** displays that the total maximum speed range of the wheelchair is not reached in the depending drive function.

In each drive card you are able to control the pre-set maximum speed depending on your needs.

- 1.

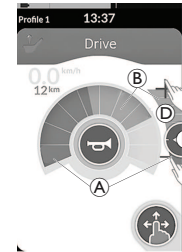

Swipe-and-tap mode	Tap-only mode
Slide set point <b>E</b> up or down, when in Swipe-and-tap mode.	Tap at top or at bottom of speed slider <b>D</b> , when in Tap-only mode. Plus and minus symbols indicate where to tap.

The proportion of the green sections **A** and yellow sections **B** on the speed dial and the speed slider correspond to the position of the set point **E**.



As soon as you start driving, speed slider and navigation button disappear from the display. The current speed is displayed by the speedometer, if it is enabled.





The speedometer / odometer display is a new feature, introduced for LiNX MR6.0, and replaces the sweeping speed gauge that used to wrap around the speed dial.

- If both the firmware and the configuration file is greater than version 5.1.10, the new speedometer / odometer is displayed when enabled.
- If both the firmware and the configuration file is less than or equal to version 5.1.10, the previous speed indicator is displayed.
- If the firmware is greater than version 5.1.10 and the configuration file is less than or equal to version 5.1.10, no speed indicator is displayed.

## 4.8 Emergency Stop

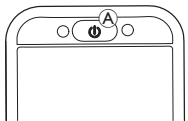

1. If you press the ON/OFF key **A** while driving, an emergency stop is carried out. The remote powers down after this.

## 4.9 Latched Driving Mode

Latched driving modes allow you to latch (or maintain) a forward or reverse speed so that you can drive without continuously providing a drive demand.



### NOTICE!

When you make a forward or reverse demand, the wheelchair drives forwards or reverse at a constant speed and will continue driving at that constant speed until one of the following occurs:

- the external stop switch is pressed (refer to [4.9.1 External Stop Switch, page 38](#)),
- the emergency stop is performed (refer to [4.8 Emergency Stop, page 37](#)),
- an opposite demand is received (a reverse demand when driving forwards or a forward demand when driving reverse) or
- the Latch Drive Timeout has expired.



To avoid potentially dangerous situations Invacare recommends to make yourself familiar with the latched driving mode, especially with the demands to stop the wheelchair.



The term demand, mentioned in this manual, means the input depending on the type of control, e.g. joystick movements or sip and puff demands, refer to [4.20.6 Using the Sip-N-Puff Head Array, page 79](#) for more information about the Sip and Puff Head Array.





By default, latched driving mode is pre-set in combination with a Sip and Puff only and with a Sip and Puff Head Array. For all other types of control, latched driving mode is not a default set-up but can be enabled by your provider.



Each drive function can be assigned with a latched driving mode by your provider. There are six latched driving modes, which are indicated on the lower left of the drive card with the symbols displayed in the table below.

	1 Step Up		3 Step Up/Down
	3 Step Up		5 Step Up/Down
	5 Step Up		Cruise Control

-  The Latch Drive Timeout period is restarted whenever a subsequent drive demand is given.
-  The Latch Drive Timeout is set by the provider. To change the parameter, contact your provider.

## Turn Demands

The wheelchair can be steered while in latched driving mode. If a turn demand is given, the wheelchair remains in latched driving mode and also responds to the turn demand for the duration that the turn demand is given. The Latch Drive Timeout period is restarted whenever a turn demand is given. When the Latch Drive Timeout expires, the wheelchairs stops.

### 4.9.1 External Stop Switch

To set up a wheelchair for latched driving, an external stop switch must be fitted to the wheelchair. Ideally, the external stop switch should be highly visible and easily accessible to provide an extra level of safety and security for the user.

#### External Stop Switch Test

The external stop switch test checks that the external stop switch is functioning correctly. The test is conducted once per power cycle when:

- the wheelchair is powered up in a latched drive mode function or
- a latched drive mode function is selected following a non-latched mode function.

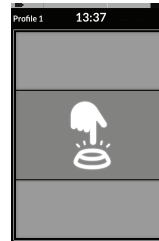

The external stop switch test is indicated by a screen overlay.

1. Press external stop switch to complete test.

-  The wheelchair does not drive until the external stop switch test is completed successfully.

## 4.9.2 1 Step Up



In this mode, a single drive demand (forward or reverse) causes the wheelchair speed to accelerate to the maximum drive speed **A** of the selected drive card and then remain at that speed for the programmed Latch Drive Timeout period as long as no further demand is given.



### Accelerating

1. Give drive demand in desired direction (forward or reverse).
2. Release drive demand. Wheelchair speed accelerates to maximum drive speed of the selected drive card.

### Decelerating

When stopping, the speed decelerates to zero at one of two rates (normal or gentle), depending on how the deceleration is triggered (long or short demand) and if the optional slower rate is configured by the provider.

#### Normal Rate

1. Give long drive demand, greater than one second, in opposite direction (a reverse demand when driving forwards or a forward demand when driving in reverse) or press external stop switch.

#### Gentler Rate

1. Give short drive demand, less than one second, in opposite direction (a reverse demand when driving forwards or a forward demand when driving in reverse) or let Latch Drive Timeout expire.

### Interrupting Deceleration

When stopping (except for an emergency stop or control input configured for a stop), the deceleration can be interrupted to resume driving.

1. Give drive demand for accelerating before speed has reached zero, so speed accelerates to maximum drive speed of the selected drive card.

### 4.9.3 3 Step Up



In this mode, you can step through one of three fixed speeds. The speeds available are 33 %, 67 % and 100 % of the maximum pre-set reverse or forward speed (A) of the selected drive card and then remain at that speed for the programmed Latch Drive Timeout period as long as no further demand is given.



#### Accelerating

1. Give drive demand in desired direction (forward or reverse).
2. Release drive demand. Wheelchair speed accelerates to 33 % of the maximum drive speed.
3. Give forward demand when driving forwards or reverse demand when driving in reverse to accelerate to next fixed speed.
4. Release drive demand. New speed is held constantly.

#### Decelerating

When stopping, the speed decelerates to zero at one of two rates (normal or gentle), depending on how the deceleration is triggered (long or short demand) and if the optional slower rate is configured by the provider.

##### Normal Rate

1. Give long drive demand, greater than one second, in opposite direction (a reverse demand when driving forwards or a forward demand when driving in reverse) or press external stop switch.

##### Gentler Rate

1. Give short drive demand, less than one second, in opposite direction (a reverse demand when driving forwards or a forward demand when driving in reverse) or let Latch Drive Timeout expire.

#### Interrupting Deceleration

When stopping (except for an emergency stop or control input configured for a stop), the deceleration can be interrupted to resume driving.

1. Give drive demand for accelerating before speed has reached zero, so speed accelerates to nearest higher fixed speed.

## 4.9.4 5 Step Up



In this mode, you can step through one of five fixed speeds. The speeds available are 20 %, 40 %, 60 %, 80 % and 100 % of the maximum pre-set reverse or forward speed **A** of the selected drive card and then remain at that speed for the programmed Latch Drive Timeout period as long as no further demand is given.



### Accelerating

1. Give drive demand in desired direction (forward or reverse).
2. Release drive demand. Wheelchair speed accelerates to 20 % of the maximum drive speed.
3. Give forward demand when driving forwards or reverse demand when driving in reverse to accelerate to next fixed speed.
4. Release drive demand. New speed is held constantly.

### Decelerating

When stopping, the speed decelerates to zero at one of two rates (normal or gentle), depending on how the deceleration is triggered (long or short demand) and if the optional slower rate is configured by the provider.

#### Normal Rate

1. Give long drive demand, greater than one second, in opposite direction (a reverse demand when driving forwards or a forward demand when driving in reverse) or press external stop switch.

#### Gentler Rate

1. Give short drive demand, less than one second, in opposite direction (a reverse demand when driving forwards or a forward demand when driving in reverse) or let Latch Drive Timeout expire.

### Interrupting Deceleration

When stopping (except for an emergency stop or control input configured for a stop), the deceleration can be interrupted to resume driving.

1. Give drive demand for accelerating before speed has reached zero, so speed accelerates to nearest higher fixed speed.

### 4.9.5 3 Step Up / Down



In this mode, you can step up or down through one of three fixed speeds. The speeds available are 33 %, 67 % and 100 % of the maximum pre-set reverse or forward speed **A** of the selected drive card and then remain at that speed for the programmed Latch Drive Timeout period as long as no further demand is given.



#### Accelerating

1. Give drive demand in desired direction (forward or reverse).
2. Release drive demand. Wheelchair speed accelerates to 33 % of the maximum drive speed.
3. Give forward demand when driving forwards or reverse demand when driving in reverse to accelerate to next fixed higher speed.  
Give reverse demand when driving forwards or forward demand when driving in reverse to decelerate to next fixed lower speed.



Drive demand in opposite direction must be quick, less than one second, otherwise wheelchair stops.

4. Release drive demand. New speed is held constantly.

#### Decelerating

When stopping, the speed decelerates to zero at one of two rates (normal or gentle), depending on how the deceleration is triggered (long or short demand) and if the optional slower rate is configured by the provider.

##### Normal Rate

1. Give long drive demand, greater than one second, in opposite direction (a reverse demand when driving forwards or a forward demand when driving in reverse) or press external stop switch.

##### Gentler Rate

1. Give short drive demand, less than one second, in opposite direction (a reverse demand when driving forwards or a forward demand when driving in reverse) or let Latch Drive Timeout expire.

#### Interrupting Deceleration

When stopping (except for an emergency stop or control input configured for a stop), the deceleration can be interrupted to resume driving.

1. Give drive demand for accelerating before speed has reached zero, so speed accelerates to nearest higher fixed speed.

## 4.9.6 5 Step Up / Down



In this mode, you can step up or down through one of five fixed speeds. The speeds available are 20 %, 40 %, 60 %, 80 % and 100 % of the maximum pre-set reverse or forward speed **A** of the selected drive card and then remain at that speed for the programmed Latch Drive Timeout period as long as no further demand is given.



### Accelerating

1. Give drive demand in desired direction (forward or reverse).
2. Release drive demand. Wheelchair speed accelerates to 20 % of the maximum drive speed.
3. Give forward demand when driving forwards or reverse demand when driving in reverse to accelerate to next fixed higher speed.  
Give reverse demand when driving forwards or forward demand when driving in reverse to decelerate to next fixed lower speed.



Drive demand in opposite direction must be quick, less than one second, otherwise wheelchair stops.

4. Release drive demand. New speed is held constantly.

### Decelerating

When stopping, the speed decelerates to zero at one of two rates (normal or gentle), depending on how the deceleration is triggered (long or short demand) and if the optional slower rate is configured by the provider.

#### Normal Rate

1. Give long drive demand, greater than one second, in opposite direction (a reverse demand when driving forwards or a forward demand when driving in reverse) or press external stop switch.

#### Gentler Rate

1. Give short drive demand, less than one second, in opposite direction (a reverse demand when driving forwards or a forward demand when driving in reverse) or let Latch Drive Timeout expire.

### Interrupting Deceleration

When stopping (except for an emergency stop or control input configured for a stop), the deceleration can be interrupted to resume driving.

1. Give drive demand for accelerating before speed has reached zero, so speed accelerates to nearest higher fixed speed.

## 4.9.7 Cruise Control



In this mode, you do not have fixed steps and can choose the latched speed by yourself and then remain at that speed for the programmed Latch Drive Timeout period as long as no further demand is given.



### Accelerating / Decelerating

1. Give and hold drive demand in direction (forward or reverse) until wheelchair accelerates to desired speed.
2. Release drive demand. Wheelchair speed is held constantly.
3. If maximum drive speed **A** is not reached, give and hold drive demand again in same direction.
4. Release drive demand. New speed is held constantly.
5. Give drive demand in opposite direction (reverse when driving forwards or forward when driving in reverse) to decelerate speed.
6. Release drive demand. New speed is held constantly.

### Stopping

Apart from using an emergency stop or a control input configured for a stop, there are different ways to stop the power wheelchair.

1. Give two short drive demands (less than one second) in same direction to stop at a normal deceleration rate.
2. Give and hold drive demand in opposite direction (reverse when driving forwards or forward when driving in reverse) until power wheelchair stops. When decelerating in this mode, speed decelerates at rate determined by provider.

### Interrupting Deceleration

When stopping (except for an emergency stop or control input configured for a stop), the deceleration can be interrupted to resume driving.

1. Give drive demand for accelerating before speed has reached zero, so speed accelerates to whatever point demand is released.



## 4.10 Operating Lighting Functions and Horn

### 4.10.1 Operating the Position Lights

-  If you drive outside, turn on the position lights under bad visibility conditions or darkness.  
To operate the position lights, you need to stop the power wheelchair.

#### Turn on Position Lights

- 

Tap Lighting control button (A).

- 

Lighting button panel overlays screen.  
Tap Position lights symbol (B).  
Position lights turn on.

 If you start driving, the Lighting button panel overlay disappears automatically and the lights remain turned on otherwise tap button (C) to close Lighting button panel.



Position lights telltale becomes illuminated in the lighting dashboard.

#### Turn off Position Lights

- 

Tap Lighting control button (A).

- 

Lighting button panel overlays screen.  
Tap Position lights symbol (B).  
Position lights turn off.

 If you start driving, the Lighting button panel overlay disappears automatically, otherwise tap button (C) to close Lighting button panel.

## 4.10.2 Operating the Hazard Lights

 To operate the hazard lights, you need to stop the power wheelchair.

### Turn on Hazard Lights

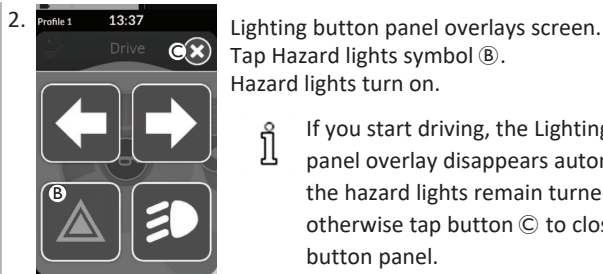
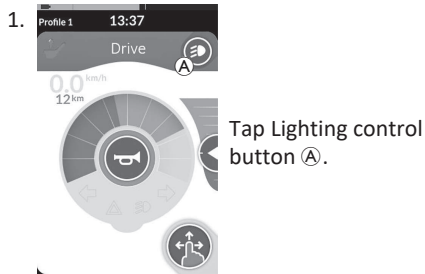

 If you start driving, the Lighting button panel overlay disappears automatically and the hazard lights remain turned on otherwise tap button **C** to close Lighting button panel.

### Turn off Hazard Lights

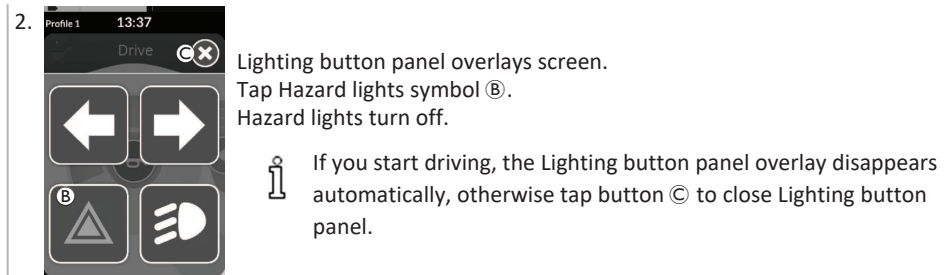
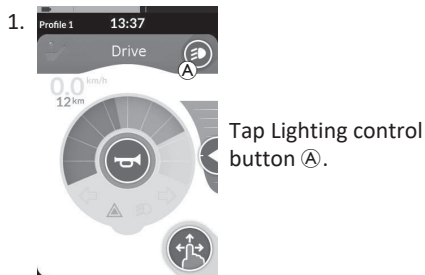

### 4.10.3 Operating the Direction Indicators

 To operate the direction indicators, you need to stop the power wheelchair.

#### Turn on Direction Indicators

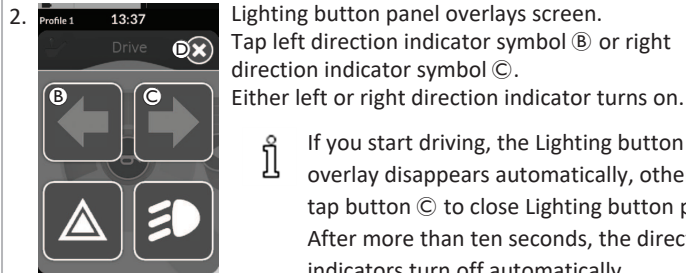



 If you start driving, the Lighting button panel overlay disappears automatically, otherwise tap button **C** to close Lighting button panel. After more than ten seconds, the direction indicators turn off automatically.

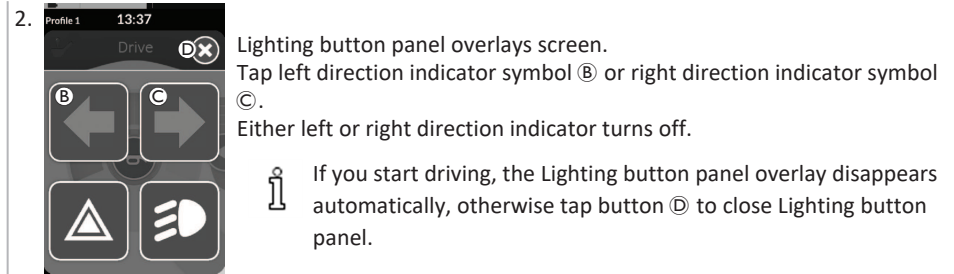

Left or right indicator telltale becomes illuminated in the lighting dashboard.

#### Turn off Direction Indicators



 If you start driving, the Lighting button panel overlay disappears automatically, otherwise tap button **D** to close Lighting button panel.

#### 4.10.4 Operating the Horn



1. Tap horn button **A** to sound horn.  
Horn sounds as long as button is tapped.

#### 4.11 Operating Lighting Functions and Horn via Utility Function Card

Via a utility function card you are able to operate the lighting functions and horn with an external input. The utility function card is part of one or more profiles and can be activated like a drive or seating function card.



1. Activate utility function card.
2. Give demand according following list.
  - Give forward demand **A** to sound horn.
  - Give short demand to right **B** to turn on/off position lights.
  - Give short demand to left **C** to turn on/off hazard lights.
  - Give long demand to left or right **D** to turn on left or right direction indicator. A short demand can be used to turn them off.



Direction indicators turn off automatically after ten seconds. Activate a drive function card to drive normally, while position lights and hazard lights remain turned on.

## 4.12 Locking / Unlocking the Remote

By default, lock function is disabled. Contact your provider to change the configuration. If the function is enabled, the system can be locked / unlocked using below described sequence.

### Locking the Remote



1. Press ON/OFF key for more than three seconds, until a locking overlay is displayed.
2. Remote powers down.  
When powering up remote, locking overlay is displayed.

### Unlocking the Remote

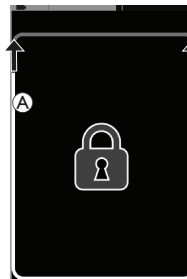

1. Press ON/OFF key.
2. Tap on locked display until white frame around locking screen **A** is filled.
3. Touch display is unlocked and can be used again.



If you do not apply the unlock sequence or the ON/OFF key is pressed again before the unlock sequence is complete, the system returns to the locked state and powers down.

## 4.13 Rest Mode

Rest mode provides an environment (or state), where the primary input is disabled, but control inputs can still be operated. When in this mode you are free to perform other activities with the confidence that any subsequent demands, intentional or accidental, from the primary input do not result in a driving or seating action.



Rest mode is indicated by the rest screen.

Rest can be entered automatically after a period of user inactivity (timeout) or manually via a control input (CI).

To resume normal operation, rest is exited via a control input. This control input can be one that is configured to return to the function or menu before entering rest or the control input can be one that is configured to toggle the user functions, menu navigation or settings menu.

<b>UserFunction</b>	Enter <b>Rest</b> from drive or seating function via timeout. →	<b>Rest</b>		<b>Sleep</b>
	Enter <b>Rest</b> from any <b>User Function</b> via CI. →			
	Exit <b>Rest</b> via CI configured to enter <b>User Functions</b> . ←			
Exit <b>Rest</b> via CI specially configured to exit <b>Rest</b> and return to location before entering <b>Rest</b> . ↵	Enter <b>Sleep</b> from <b>Rest</b> via timeout. →			
<b>IndirectNavigation</b>	Enter <b>Rest</b> from <b>Indirect Navigation</b> via timeout. →			
	Enter <b>Rest</b> from <b>Indirect Navigation</b> via CI. →			
	Exit <b>Rest</b> via CI configured to enter <b>Indirect Navigation</b> . ←	<b>Rest</b> is exited when system is power cycled. ↓		
<b>Settings</b>	Exit <b>Rest</b> via CI configured to enter <b>Settings</b> . ←			

#### 4.14 The Sleep Mode

The sleep mode is no factory setting, but can be enabled by your provider. If this parameter is set ON, the system goes into sleep mode after a period of time without user activity. This period can be set by the provider.

Before a system goes into sleep mode, the system enters a transition period. During the transition period, the touch display and all indicators slowly dim until they are switched off.

During this transition period sleep mode can be interrupted by performing any input by moving the joystick, pressing the ON/OFF key or tapping on the touch display.

To wake the system from sleep mode, move the joystick or either press the ON/OFF key, if this parameter has been enabled by your provider.

## 4.15 Operating Powered Seating Functions

Powered seating functions, such as powered elevating legrests or powered recline, are carried out as described below.

### 4.15.1 Through Seating Cards



By default, every seating card displays a single powered seating function. Different configurations are listed below. Contact your provider to change the configuration.

Choose the seating card with the seating function you want to operate, refer to *4.3 Selecting Functions, page 23*.



1. Give forward or reverse demand to operate seating function. When a motion becomes active, navigation button disappears (A), the active direction of the motion (B) is displayed, the other becomes inactive (C) and drive inhibit / lockout icon (D) is displayed in the status bar. Motion is deactivated as soon as demand is released or when motion reaches its end-of-travel.

### Displayed Symbols And Their Meanings

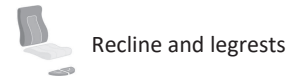
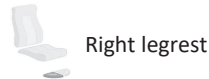
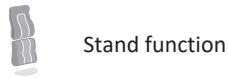
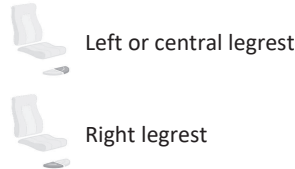
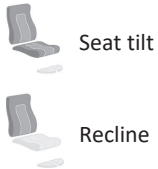

## Other Configurations



The displayed function cards are configuration examples only.

### • Four Quadrant Configuration

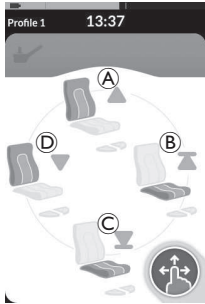

- Ⓐ Recline up
- Ⓑ Seat lifter up
- Ⓒ Seat lifter down
- Ⓓ Recline down

All four quadrants are used for operating powered seating functions.

1. Give and hold forward Ⓐ, reverse Ⓒ, left Ⓓ or right demand Ⓑ to operate seating function. Motion is deactivated as soon as demand is released or when motion reaches its end-of-travel.

### 4.15.2 Through External Switches



Not all configurations and combinations of powered seating functions through external switches are available on all products.

### • Latched Configuration

A latched configuration allows you to operate a motion without continuously providing a demand.

A latched configuration can be a single powered seating function or a four quadrant configuration.



1. Give demand to front or rear to operate seating function.
2. Release demand. Motion is deactivated as soon as joystick is deflected again or when motion reaches its end-of-travel.



In a four quadrant configuration it is possible to mix the motion operations, like displayed in the example.



With an external switch, seating functions can be controlled while driving and without using seating cards.

When the seating function is activated without a seating card, a small overlay is displayed on the touch display, to inform the user, that the seating is being controlled externally. The overlay remains on the touch display for the duration of the seating operation.

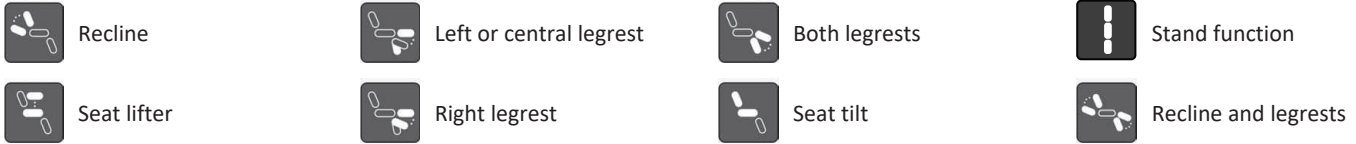

### Stereo Switches

The stereo toggle switch / stereo button switch alternates powered seating functions of the following single power configurations:

- Recline only
- Seat tilt only
- Central legrest (LNX) only

#### Stereo Toggle Switch

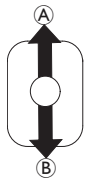

1. Make sure power wheelchair is on level surface and turned on.
2. Deflect and hold toggle switch up **A** or down **B** to move particular seating function.  
Seating function moves as long as toggle switch is deflected.

#### Stereo Button Switch

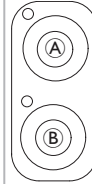

1. Make sure power wheelchair is on level surface and turned on.
2. Press and hold stereo buttons **A** or **B** to move particular seating function.  
Seating function moves as long as button is pressed.

## 4-way Toggle Switch

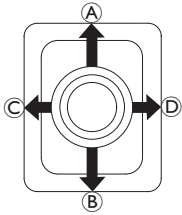

1. Make sure power wheelchair is on level surface and turned on.
  2. Deflect and hold toggle switch to direction, that moves particular seating function. Seating function moves as long as toggle switch is deflected.
- See tables below for combinations of directions and powered seating functions.



The tables shows the factory settings. For reprogramming, contact your provider.

Seat Tilt and Recline		Seat Tilt and LNX Legrest		Recline and LNX Legrest	
Ⓐ (Forward)	Seat tilt up	Ⓐ (Forward)	Seat tilt up	Ⓐ (Forward)	Recline and LNX up
Ⓑ (Reverse)	Seat tilt down	Ⓑ (Reverse)	Seat tilt down	Ⓑ (Reverse)	Recline and LNX down
Ⓒ (Left)	Recline up	Ⓒ (Left)	LNX up	Ⓒ (Left)	LNX up
Ⓓ (Right)	Recline down	Ⓓ (Right)	LNX down	Ⓓ (Right)	LNX down

Seat Tilt and Seat Lifter		Both Legrests		Stand Function and Seat Lifter	
Ⓐ (Forward)	Seat tilt up	Ⓐ (Forward)	Left legrest up	Ⓐ (Forward)	Stand function up
Ⓑ (Reverse)	Seat tilt down	Ⓑ (Reverse)	Left legrest down	Ⓑ (Reverse)	Stand function down
Ⓒ (Left)	Seat lifter up	Ⓒ (Left)	Right legrest up	Ⓒ (Left)	Seat lifter up
Ⓓ (Right)	Seat lifter down	Ⓓ (Right)	Right legrest down	Ⓓ (Right)	Seat lifter down

## 4-way Button Switch

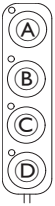

1. Make sure power wheelchair is on level surface and turned on.
2. Press and hold button to move particular seating function.  
Seating function moves as long as button is pressed.  
See tables below for combination of buttons and powered seating functions.



The tables shows the factory settings. For reprogramming, contact your provider.

Seat Tilt and Recline		Seat Tilt and LNX Legrest		Recline and LNX Legrest	
Ⓐ	Seat tilt up	Ⓐ	Seat tilt up	Ⓐ	Recline and LNX up
Ⓑ	Seat tilt down	Ⓑ	Seat tilt down	Ⓑ	Recline and LNX down
Ⓒ	Recline up	Ⓒ	LNX up	Ⓒ	LNX up
Ⓓ	Recline down	Ⓓ	LNX down	Ⓓ	LNX down

Seat Tilt and Seat Lifter		Both Legrests		Stand Function and Seat Lifter	
Ⓐ	Seat tilt up	Ⓐ	Left legrest up	Ⓐ	Stand function up
Ⓑ	Seat tilt down	Ⓑ	Left legrest down	Ⓑ	Stand function down
Ⓒ	Seat lifter up	Ⓒ	Right legrest up	Ⓒ	Seat lifter up
Ⓓ	Seat lifter down	Ⓓ	Right legrest down	Ⓓ	Seat lifter down

## 10-way Switch

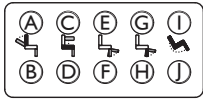

1. Make sure power wheelchair is on level surface and turned on.
2. Press and hold button to move particular seating function.  
Seating function moves as long as button is pressed.



If the stand function is available for your power wheelchair, buttons **G** and **H** are used to operate the stand function.

- |                       |                           |  |  |                         |
|-----------------------|---------------------------|--|--|-------------------------|
| <b>A</b> Recline down | <b>C</b> Seat lifter up   | <b>E</b> Left or central legrest up      | <b>G</b> Right legrest up /<br>Stand function up     | <b>I</b> Seat tilt up   |
| <b>B</b> Recline up   | <b>D</b> Seat lifter down | <b>F</b> Left or central legrest<br>down | <b>H</b> Right legrest down /<br>Stand function down | <b>J</b> Seat tilt down |

### 4.15.3 Speed Reduction and Seating Function Inhibits

 The mentioned speed reduction and seating function inhibits do not apply to all Invacare wheelchair models.

#### Driving Function Inhibits

- **Drive Lockout**

Drive lockout (DLO) is a function to prevent the wheelchair from being driven when the seat tilt or recline are beyond a pre-determined safe total angle. The total angle can be any combination of seat angle, recline and / or surface angle. For most of the Invacare wheelchair models, Drive lockout only responds when you adjust angles in standstill. AVIVA RX makes an exception: Drive lockout also responds while driving.



According to that, an icon is displayed in the status bar. This indicator remains active until Drive lockout is deactivated by adjusting seat angle and backrest angle.

- **Speed Reduction**

If the seat lifter or the seat angle has been adjusted above a certain point, the drive electronics considerably reduces the speed of the wheelchair. If speed reduction has been activated, drive mode can only be used to carry out movements in reduced speed and not for regular driving. To drive normally, adjust the lifter or the seat angle until the speed reduction is deactivated again.



Speed reduction is shown in the display. If the seat lifter or the seat angle is raised above a certain point, the above icon is displayed in the status bar. This indicator remains active until speed reduction is deactivated again by lowering the lifter.

## Seating Function Inhibits

- **Tilt Limit**

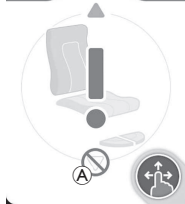

The maximum tilt limit switch is a function to prevent the seat tilt or recline from extending beyond a maximum pre-set angle, when the seat lifter is raised above a certain point. The drive electronics stops automatically, a grey exclamation point is displayed on the seating card and tilting or reclining backwards is inhibited (A).



According to that, an icon with a seat and an exclamation point is displayed in the status bar. This indicator remains active until the tilt limit is deactivated by lowering the lifter.

- **Lifter Seat Lockout**

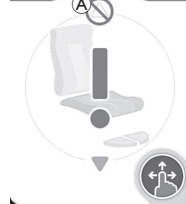

The drive electronics is equipped with a sensor to prevent the seat lifter from rising up above a certain point when the seat tilt or recline is adjusted above a certain point. The drive electronics stops automatically, a grey exclamation point is displayed on the seating card and extend is inhibited (A).



According to that, an icon with a seat and an exclamation point is displayed in the status bar. This indicator remains active until the lifter seat lockout is deactivated by moving seat tilt or recline up.

## 4.16 Configuring Connectivity Cards

Connectivity cards allow you to communicate with external devices. Connectivity functions supported by your remote are a mouse mover and a switch control. By default, these functions are disabled. Contact your provider to activate Connectivity Cards.

The mouse mover function allows you to control the cursor on a PC or laptop's screen with a user input on the wheelchair, such as the joystick on the remote module or external joysticks. At the moment a four-quadrant operation is needed to use the mouse mover.

The switch control function is an accessibility feature that allows you to navigate and select items on your mobile device (Android and iOS) using the remote's joystick or touch screen.

## 4.16.1 Pairing LiNX System

### Pairing with User's Device

To pair the LiNX system with a user's device (PC, laptop or mobile device), open the connectivity settings menu.

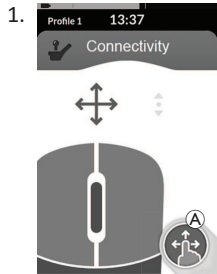

Long press navigation button **A**.

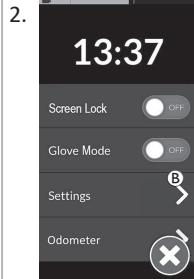

Status display opens. Open Settings menu **B**.

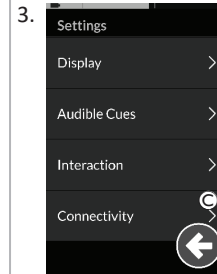

Settings menu opens. Open Connectivity settings **C**.

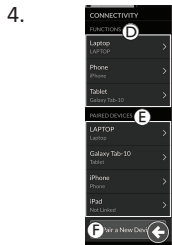

Connectivity settings menu opens. This menu is split into two sections:

**D** Functions **E** Paired devices

Tap on **Pair New Device** button **F** at bottom of menu.

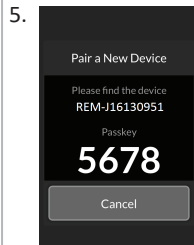

Pairing passkey is displayed on touch screen with the name of LiNX device to pair with, in this example REM-J16130951.

### Pairing Mobile Device with LiNX System



Perform this operation promptly to the Pairing process on your remote. Otherwise, a timeout will occur.

See your mobile device's user manual for information about how to establish a Bluetooth connection with your remote.

## Pairing PC or Laptop with LiNX System



Perform this operation promptly to the Pairing process on your remote. Otherwise, a timeout will occur.

1. Open **Devices and Printers** dialog box on your Windows PC or laptop.

There are a number of ways to do this:

- Start → Devices and Printers,
- Start → Control Panel → Devices and Printers,
- Icon tray → click on Bluetooth Device icon

- 2.

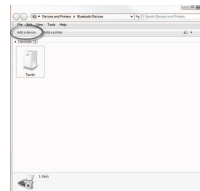

From **Devices and Printers** dialog box, click on **Add a device** button.

- 3.

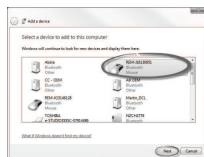

All available devices are displayed. Locate LiNX device name that is displayed on the touch screen (REM-J16130951) and select it. Click on **Next** button.

- 4.



Wait for device to connect.  
Click on **Next** as soon as device is connected.

- 5.

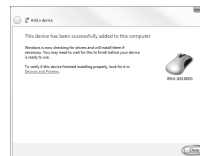

Click on **Close** button to complete **Add a device** action.

- 6.

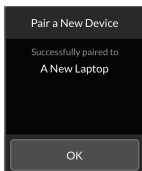

If the device paired successfully, a confirmation screen is displayed on the remote module. Tap on the **OK** button to proceed.

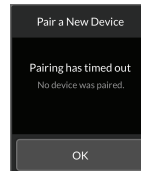

If no device is paired within the set timeout period, a message is displayed "No device was paired". Tap on **OK** button to proceed.



LiNX system permits up to ten devices to be paired at any time. If you have reached this limit and you need to add more devices, consider forgetting devices, that have already been paired, refer to 4.17.2 *Operating the Mouse Mover*, page 65.

## 4.16.2 Linking Connectivity Card with User's Device

Connectivity cards must be linked to a paired device. To link a connectivity card to a device, open the connectivity settings menu.

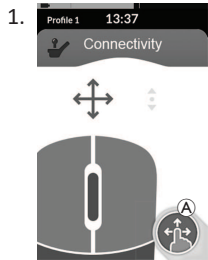

1.

Long press navigation button (A).

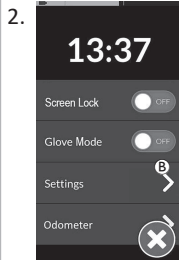

2.

Status display opens. Open Settings menu (B).

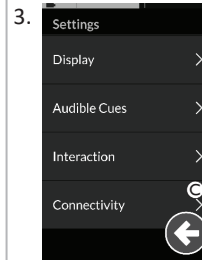

3.

Settings menu opens. Open Connectivity settings (C).

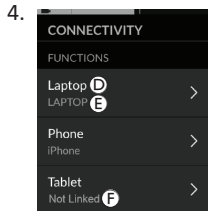

4.

The names of the connectivity cards are displayed in section **Functions**.

- (D) Function name
- (E) Linked device
- (F) No linked device

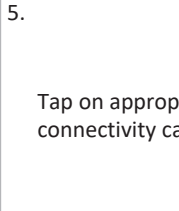

5.

Tap on appropriate menu item to link connectivity card with a paired device.

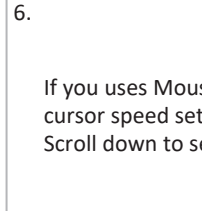

6.

If you use Mouse mover function card, cursor speed settings are displayed on top. Scroll down to section **Function Uses Device**.

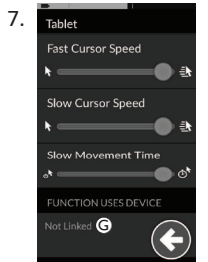

7.

Tap on **Not Linked** button (G).

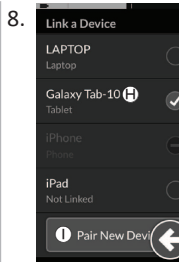

8.

Select one of paired devices in list (H), or tap on **Pair New Device** button (I) to pair with new device. Currently active device is identified by a green hook behind the device name.



### 4.16.3 Connecting Devices with LiNX System

To connect to a device, select the appropriate connectivity card from a profile. If the connectivity function has been paired to a device and the device has been linked to the function, then it attempts to connect to the device via Bluetooth.

The Bluetooth status indicator shows when the Bluetooth connection between the LiNX system and the user's device is:

- disconnected,  • connecting  • or connected. 

If the Bluetooth fails to connect, the status reverts to disconnected.

### 4.16.4 Removing Paired Devices

- 

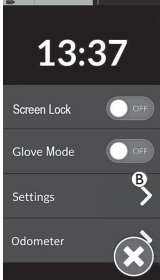
1. Long press navigation button (A).
- 

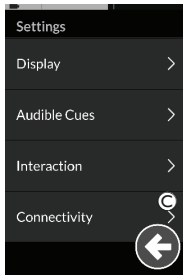
2. Status display opens. Open Settings menu (B).
- 

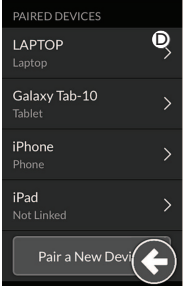
3. Settings menu opens. Open Connectivity settings (C).
- 

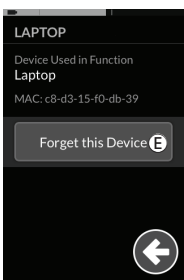
4. Select paired device in section **Paired Devices**, e. g. Laptop (D).
- 

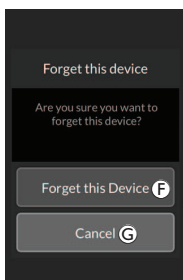
5. Check details on following screen and tap **Forget this Device** button (E).
- 

6. Tap on **Forget this Device** button (F) again or **Cancel** button (G), to cancel removing.

#### 4.16.5 Selecting Connectivity Card

For more information about selecting user function cards, refer to *4.4 Using Direct Navigation, page 24* or *4.5 Using Indirect Navigation, page 25*.



If a connectivity card in the profile has not been configured fully or is subject to an error, it will be classed as inoperable.

There is a number of reasons why a connectivity card is inoperable. These are:

- the function's primary input is missing,
- there are hardware errors from the Bluetooth module,
- there is no device linked or
- Bluetooth has not been enabled.

For the latter two reasons, the card can be selected as these are rectified later.

## 4.17 Mouse Mover

	Ⓐ	Connectivity card name	The name can be used to uniquely identify this card's purpose.	
	Ⓑ	Mouse move indicator		The mouse move indicator changes from grey to blue when active. That is, when the user input is controlling the connected device's cursor.
	Ⓒ	Left mouse button	Tap on the touch screen's left and right mouse buttons to perform left and right mouse clicks.	
	Ⓓ	Right mouse button		
	Ⓔ	Scroll indicator		The scroll indicator changes from grey to blue when active. That is, when the user input is controlling the connected device's scrolling.
	Ⓕ	Bluetooth connection status		The Bluetooth status indicator shows the status of the Bluetooth connection between the LiNX system and your device: <ul style="list-style-type: none"> <li>• disconnected</li> <li>• connecting</li> <li>• connected</li> </ul>

### 4.17.1 Setting up a Mouse Mover

The following set-up procedure assumes that connectivity cards are available and selectable in one or more profiles and that the connectivity cards provide mouse mover functions. It also assumes that the PC or laptop, to which the LiNX system will connect, has an active Bluetooth connection.

To use a mouse mover function:

1. the LiNX system needs to be paired (via Bluetooth) with a user's device, and
2. the connectivity card needs to be linked to the paired device.

The set-up procedure can be performed in any order, but involves the following:

- Selecting a connectivity card,
- pairing the LiNX system with a user's device
- linking the connectivity card with the user's device and
- configuring the mouse mover function (cursor speed).

### Configuring the Mouse Mover Function (Cursor Speed)

The cursor speed settings can be found in the connectivity function's menu.



Long press navigation button (A).

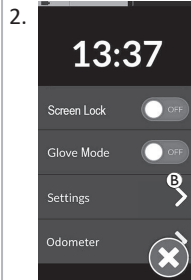

Status display opens. Open Settings menu (B).

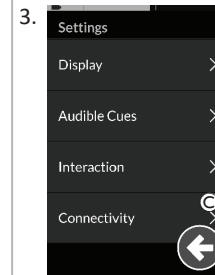

Settings menu opens. Open Connectivity settings (C).

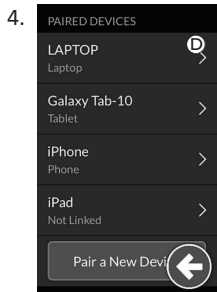

Open connectivity function, e.g. (D), to configure cursor settings.

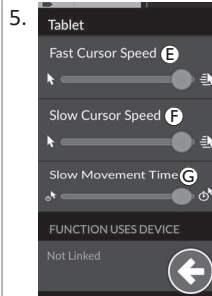

For each mouse mover function the following cursor settings can be set:

- Fast Cursor Speed (E)
- Slow Cursor Speed (F)
- Slow Movement Time (G)

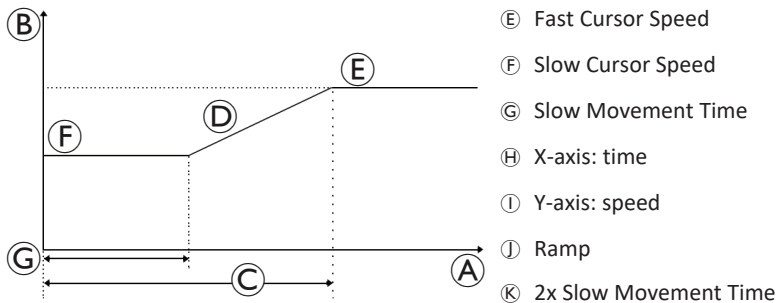

**Fast Cursor Speed (Ⓔ):** Sets the speed at which the mouse cursor ramps (Ⓝ) up to after the Slow Movement Time (Ⓖ) has expired. During the Slow Movement Time however, the mouse cursor speed moves at the speed set by Slow Cursor Speed (Ⓕ). The Fast Cursor Speed is set so that you can move the cursor quickly over large distances. Fast Cursor Speed should be set equal to or greater than Slow Cursor Speed.

**Slow Cursor Speed (Ⓕ):** Sets the speed at which the mouse cursor moves when initially deflected. It remains at this speed for the duration set by the Slow Movement Time (Ⓖ). The Slow Cursor Speed is set so that you can move the mouse cursor slowly over small distances, which is useful for small adjustments, especially when moving between screen icons that are close together. Slow Cursor Speed should be set equal to or less than Fast Cursor Speed (Ⓔ).

**Slow Movement Time (Ⓖ):** Sets the length of time for which the mouse moves at the Slow Cursor Speed (Ⓕ) before increasing to the Fast Cursor Speed (Ⓔ). The ramp time, between end of Slow Cursor Speed and start of Fast Cursor Speed, is equal to the time set by this setting (Ⓚ).

#### 4.17.2 Operating the Mouse Mover

The following operation description assumes that a connectivity card with a mouse mover function has been set up as described in *4.17.1 Setting up a Mouse Mover, page 63*.

##### Moving the Cursor

The cursor moves on the user's device in the direction that is mapped to the input. The speed of the cursor is slow initially, which is ideal for close or fine movements and then speeds up after a short period (defined by Slow Movement Time) to allow the cursor to move a greater distance in a shorter time frame. For more information about cursor settings, refer to *4.17.1 Setting up a Mouse Mover, page 63*.

### Right or Left Click



- To perform a right or left click, tap on the corresponding buttons (A) or (B) on the touch screen. When a button is tapped, it changes colour from grey to blue.

### Scrolling

The scroll mode button is an external button, such as an egg switch or buddy button.

- Press and hold scroll mode button.
- Use assigned user input or programmed control inputs to perform up and down scroll actions.
- To stop scrolling, release scroll mode button.

### Disconnecting

To stop using the mouse mover function, select a different function card from a profile. When the connectivity card has been deselected, the Bluetooth connection disconnects.

## 4.18 Switch Control

	(A)	Connectivity card name	The name can be used to uniquely identify this card's purpose.	
	(B)	Bluetooth connection status		The Bluetooth status indicator shows the status of the Bluetooth connection between the LiNX system and your device: <ul style="list-style-type: none"> <li>disconnected</li> <li>connecting</li> <li>connected</li> </ul>
	(C)	Switch control indication		The switch control indication varies depending on if your device is connected via Bluetooth and whether or not a switch control input is active: <ul style="list-style-type: none"> <li>disconnected</li> <li>connected</li> <li>active</li> </ul>

### 4.18.1 Setting up switch control

The following set up procedure assumes that a switch control connectivity card is available and selectable in one or more profiles. It also assumes that the user's device (iOS or Android) to which the LiNX system connects to, has an active Bluetooth connection.

To use a switch control function:

1. the LiNX system needs to be paired (via Bluetooth) with a user's device, and
2. the switch control connectivity card needs to be linked to the paired device.

The set up process is performed in any order, but will involve the following:

- Selecting a switch control connectivity card,
- pairing the LiNX system with a user's device,
- linking the switch control connectivity card with the user's device, and
- configuring switch control.

### Configuring switch control

Before you can use switch control, you need to identify the switches you will be using and assign an action to each switch. For example, if you want your mobile phone to return to Home screen when you tap on the remote's touch screen, you will need to identify the touch screen as a switch input, and then assign that switch's action to Home button.

### 4.18.2 Configuring Switch Control (Android)

Based on different Android version in the market, the description on your mobile device can differ. For more information look into your user manual or at **Android Accessibility Help** pages.

1.

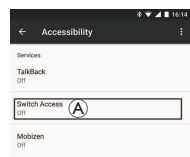

**Settings**  
> **Accessibility**  
> **Switch Access**

Open the switch control menu (A) on your mobile device.

2.

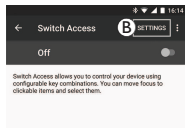

Open **Settings** (Settings) (B) menu.

3.

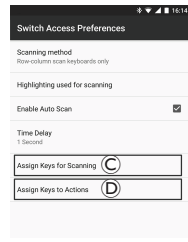

Open **Assign Keys for Scanning** (Assign Keys for Scanning) menu (C) or **Assign Keys to Actions** (Assign Keys to Actions) menu (D). Android placed functions in two different menus.

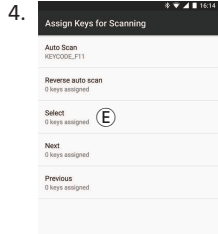

Select the function you like to control you like to control from the list, such as **Select** (Select). You are prompted to activate your external switch.

7. If required, repeat the steps to add more switches.

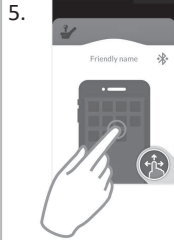

Activate the external switch, for example tap on Touch screen or deflect joystick to the left.

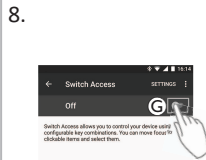

Activate Switch Control **Ⓞ**.

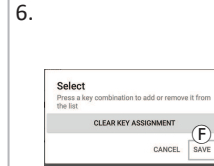

Click on button **Save** (Save).

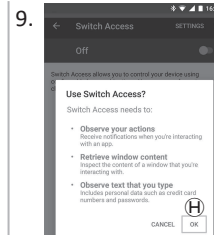

Click button **OK** **Ⓜ** to activate Switch Control.

### 4.18.3 Configuring Switch Control (iOS)

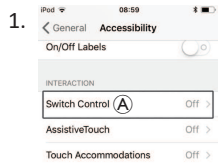

**Settings > General > Accessibility**  
Open the switch control menu **Ⓐ** on your mobile device.

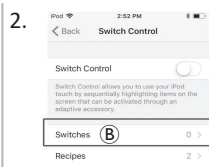

Open **Switches** (Switches) menu **Ⓑ**.



Tap on menu entry **Add new Switch** (Add New Switch) **Ⓒ**.



4.

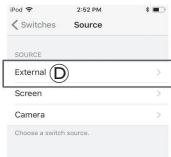

Tap on button **External** (External) **D**. You are prompted to activate the external switch.

7.

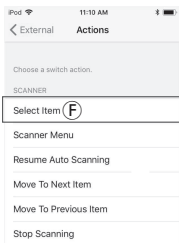

Assign an action to switch. From the **Actions** (Actions) menu choose a switch action, such as **Select Item** **F**.

5.

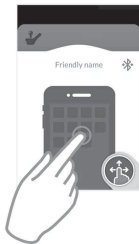

Activate external switch, for example tap on Touch screen or deflect joystick to the left.

8.

If required, repeat the steps to add more switches.

6.

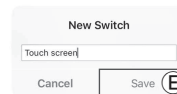

Name external input with a unique name of your input, such as **Touch screen** or **Right**. After that, click on button **Save** (Save) **E**.

9.

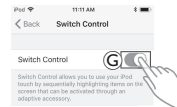

Activate Switch Control **G**.

#### 4.18.4 Operating Switch Control

The following operation description assumes that a connectivity card with a switch control function has been set up as described in *4.18.1 Setting up switch control, page 67*.

##### Controlling Mobile Device

1. Press the preassigned switch on your remote. Your mobile device executes the deposited action.

##### Disconnecting

To stop using switch control function, select a different function card from a profile. When the switch control connectivity card has been deselected, the Bluetooth connection disconnects.

## 4.19 Audible Cues

Audible cues are sounds played through the remote's speaker in response to certain system events or navigation actions. Audible cues are designed to help understand, where you are in the LiNX system and are especially beneficial for:

- users with impaired vision or
- users who cannot see the display or
- users who wish to have additional feedback from their actions, so there is no need to constantly monitor the display.

For setting up the audible cues from a remote, refer to *4.2.4 Configuring Settings, page 21*.



There are two types of audible cues.

- Event cues: These are cues played in response to system events.
- Navigation cues: These are cues played in response to menu navigation actions.

### Event Cues





 Not all system events have an audible cue. For example, no audible cue is played when the system moves into sleep mode.

Event cues comprise two or three notes and are played on entering a specific state.

Event Type	Sound	Event Cue Condition
Menu		Played when entering the navigation menu.
Rest		Played when entering rest mode.
Power off / enter sleep		Played before powering off or entering sleep mode.

## Navigation Cues



Navigation cues are played during menu navigation when highlighting a function menu item and again when entering the function card.

Navigation Type	Sound	Navigation Cue Condition
Drive function		Played when highlighting a drive menu item and again when entering the function card.
Seating function		Played when highlighting a seating menu item and again when entering the function card.
Utility function		Played when highlighting a utility menu item and again when entering the function card.
Mouse mover- / switch function		Played when highlighting a mouse mover or switch menu item and again when entering the function card.

## Function Identifier

A function identifier is an optional audible cue that is played directly after a navigation cue. It provides a count by repeating the same note and it is useful, for example, to identify functions of the same type within the same profile.

The function identifier can be set your provider. The number of times this note repeats can be **1** to **6**. This parameter can also be set to **None** or **Reverse**. If set to **None**, no function identifier cue is played after a navigation cue. If set to **Reverse**, a single note is played with a longer duration and higher frequency than the note used for the repeating function identifier.

Function = Drive 1	Identifier = None	Function = Drive 2	Identifier = 1	Function = Drive 3	Identifier = 2	Function = Drive 4	Identifier = Reverse
							

In this example four drive functions of the same profile are shown. The function identifier are has been set for each drive function with the following values: **None**, **1**, **2** and **Reverse**.

## Profile Index



A profile index is played when navigating between profiles, playing one note for the first profile, two notes for the second profile, three notes for the third profile and so on.

When navigating with menu select in list view, menu scan in list view or menu scan in grid view, the profile index is played in isolation. That means the profile index plays and no other audible cue follows.

When navigating with direct navigation or menu select in grid view, it is possible to navigate from a function in one profile to a function in an adjacent profile, so the profile index is followed by a further audible cue to identify the newly highlighted function.



For example, when navigating down from the function in the second profile, to the second function in the third profile, the profile index is followed by a further audible cue to identify this function.

## Example

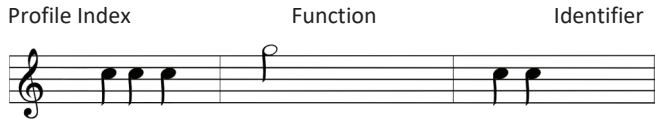

If function identifiers are used, then three sound elements are played:

1. profile index (e.g. three notes to indicate third profile)
2. navigation cue (e.g. drive function)
3. function identifier (e.g. function identifier is set to 2)

## 4.20 Using Secondary Inputs



### CAUTION! Risk of injury

If an external input is used, unrequested functions or speed settings can lead to unexpected operations.

- To avoid unexpected operations, check which function is operated and what the function's speed is set to.

If you are unable to use a standard joystick, you can control the system via an external input. All following inputs are able to control the driving function. With some of the following inputs you are also able to switch the function cards to control seating or light functions, if available.

In case of a proportional joystick or the Sip and Puff Head Array, the wheelchair can be driven forward, reverse, right or left by a four-quadrant (4Q) operation without additional switches. This is different to an operation based on three quadrants (3Q), such as a Head Array or a Four Switch Proximity Array. There you have the possibility to move forward, right or left with the aid of proximity sensors. In order to allow the wheelchair to be driven in reverse or changing function cards, an additional switch or sensor is required.

The Head Array and the Four Switch Proximity Array are provided with an Atom Box, so your provider can fit the arrays to your individual needs by using the dip switches.

Default dip switch setup:

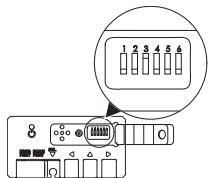

1 Reset / Reverse switch turned off.

4 Not used at the moment.

2 Not used at the moment.

5 Not used at the moment.

3 Turned on, to power up with wheelchair.

6 Audible input indicator turned off

 All components mentioned below describe the usage of the default set-up. For individual set-up, contact your provider.

#### 4.20.1 Using Swing-Away Chin Control



##### **WARNING!**

##### **Risk of Injury or Death**

Small parts can lead to choking hazard that may result in injury or death.

- Do not remove any small parts.
- Closely supervise children, pets or people with physical / mental disabilities.



##### **CAUTION!**

##### **Risk of Injury and Damage**

Remaining burrs and missing end caps after modifications on rods, such as shortened rod, can lead to injury or damage.

- Deburr cut after cutting excessive length.
- Re-install end cap after deburring.
- Check end cap for tight fitting.



##### **CAUTION!**

##### **Risk of Injury or Damage**

Clothes or personal accessories can restrict or prohibit correct function of Chin Control.

- Check correct wiring of cables before first use.
- Ensure that no clothes or accessories are in range of use at any time.



##### **NOTICE**

Additional items not belonging to Chin Control can damage it.

- Do not hang items, such as clothes or accessories, on any parts of Chin Control.

## Driving

This proportional joystick needs less force to be deflected than a standard joystick.

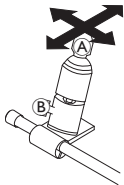

1. Deflect joystick (A) from neutral position in desired direction.

 You can use wing bolt (B) to adjust the joystick to your needs.

 For more information about driving, refer to *4.7 Proportional / Discrete Driving Mode, page 35*.

## Manual Chin Control

### Changing Function Cards

By default an egg switch, used for function or profile changes, is mounted to the headrest.

1. Short press egg switch to change function card.
2. Long press egg switch to change profile.

 For difference between function card and profile, refer to *2.2.3 User Function Card Overview, page 8*.  
For operating the powered seating functions, refer to *4.15.1 Through Seating Cards, page 51*.

### Moving Controls Inwards / Outwards

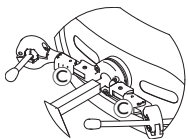

1. Press locking device (C) (behind headrest) and swivel joystick or egg switch inwards or outwards until it clicks in place.

## Powered Chin Control

### Changing Function Cards

By default Piko buttons are mounted to the Chin beam.

1. Short press black Piko button (B) to change function card.
2. Long press black Piko button (B) to change profile.

### Switching Power Wheelchair off/on

1. Press red Piko button (A) to turn power wheelchair off/on.

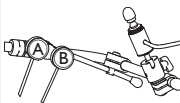

### Moving Controls Inwards / Outwards

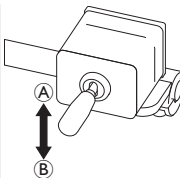

The linkage joystick controls the movement of the Chin Control.

1. Move linkage joystick in desired direction until Chin Control is in desired position.  
up (A)--> moves upwards and outwards  
down (B)--> moves downwards and inwards

## 4.20.2 Using Pediatric Compact Joystick

## 4.20.3 Using Micro Extremity Control Joystick



### WARNING!

#### Risk of Injury or Death

Loose small parts can lead to choking hazard that may result in injury or death.

- Do not remove any small parts except to replace the joystick knob.
- Do not leave removed joystick knob unattended.
- Closely supervise children, pets or people with physical / mental disabilities.

### Driving



1. Deflect joystick from neutral position in desired direction.



For more information about driving, refer to *4.7 Proportional / Discrete Driving Mode, page 35*.

### Changing Function Cards



For more information about changing the function cards, refer to *4.3 Selecting Functions, page 23*.

### Driving



This proportional joystick needs only little force to be deflected.

1. Deflect joystick from neutral position in desired direction.

### Changing Function Cards

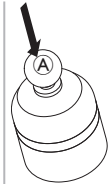

1. Short press joystick **A** to change function card.
2. Long press joystick **A** to change profile.



For difference between function card and profile, refer to *2.2.3 User Function Card Overview, page 8*.  
For operating the powered seating functions, refer to *4.15.1 Through Seating Cards, page 51*.



#### 4.20.4 Using the Compact Single Switch Joystick

##### Driving



1. Deflect joystick from neutral position in desired direction.



For more information about driving, refer to *4.7 Proportional / Discrete Driving Mode, page 35*.

##### Changing Function Cards

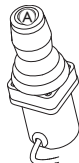

1. Short press joystick button (A) to change function card.
2. Long press joystick button (A) to change profile.



For difference between function card and profile, refer to *2.2.3 User Function Card Overview, page 8*.

For operating the powered seating functions, refer to *4.15.1 Through Seating Cards, page 51*.

#### 4.20.5 Using the Sip-N-Puff



##### CAUTION!

##### Risk of Injury or Damage

Improper mounting or maintenance of the Sip-N-Puff control including the mouthpiece and breath tube may cause injury or damage. Water inside the Sip-N-Puff interface module may cause damage to the unit.

Excessive saliva residue in the mouthpiece can reduce performance.

Blockages, a clogged saliva trap or air leaks in the system may cause Sip-N-Puff not to function properly.

- Ensure moving parts of the wheelchair, including the operation of powered seating, DO NOT pinch or damage the Sip-N-Puff tubing.
- Saliva trap MUST be installed to reduce risk of water or saliva entering the Sip-N-Puff interface module.
- Flush the mouthpiece and the breath tube at least twice a week with warm running water. Disinfect with oral rinse after cleaning.
  - The mouthpiece MUST be completely dry before installation.
- If Sip-N-Puff does not function properly, inspect system for blockages, clogged saliva trap or air leaks. As necessary, replace mouthpiece, breath tube and saliva trap.

 For further maintenance and cleaning instructions, refer to *5 Maintenance, page 91*.

 Sip and Puff is not the most manoeuvrable or intuitive control method and therefore requires a considerable amount of training. In the early tuning stages, this is best done outdoors in an unrestricted but safe area. Also the presence of an attendant is recommended.

## Driving

The drive function cards for the Sip-N-Puff are pre-set in latched driving mode. For more information, refer to *4.9 Latched Driving Mode, page 37*.

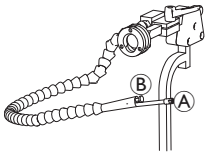

1. Puff hard into mouthpiece **A** to drive forwards.
2. Sip hard at mouthpiece to drive in reverse.
3. When in latched driving mode, puff soft into mouthpiece to veer to the right.
4. When in latched driving mode, sip soft at mouthpiece to veer to the left.

 For more information about the calibration of hard and soft demands, see the service manual of the LiNX system.

## Stopping

A lipswitch **B** is mounted to the mouthpiece. This switch can be used as an external stop switch, when in latched driving mode. While you are in latched driving, you do not need to give a drive demand all the time, but the mouthpiece must stay inside your mouth. As soon as the lipswitch is pressed while driving, the wheelchair stops.

## Changing Function Cards

The lipswitch can also be used as a mode function switch.

 For difference between function card and profile, refer to *2.2.3 User Function Card Overview, page 8*.

1. Stop wheelchair.
2. Short press lipswitch to change function card.
3. Long press lipswitch to change profile.

#### 4.20.6 Using the Sip-N-Puff Head Array

**WARNING!****Risk of serious injury**

Proximity sensors are sensitive to water. If enough water is present close to sensors, they may be activated and power wheelchair may start moving unintentionally.

- Do not operate Head Array with wet hair.
- Do not operate Head Array in wet weather.
- Do not operate Head Array in any circumstances where water may come close to sensors.

**WARNING!****Risk of serious injury**

Sensor pads are made of water resistant vinyl to get water quickly run off the pads before activating sensors.

If sensor pads are damaged, water may get in and power wheelchair may start driving unintentionally.

If sensor pads are covered by water absorbing material, power wheelchair may start driving unintentionally.

- Do not operate Head Array if sensor pads are damaged. Change sensor pads immediately.
- Do not cover sensor pads with any material.

**CAUTION!****Risk of Injury or Damage**

Improper mounting or maintenance of the Sip-N-Puff control including the mouthpiece and breath tube may cause injury or damage.

Water inside the Sip-N-Puff interface module may cause damage to the unit. Excessive saliva residue in the mouthpiece can reduce performance. Blockages, a clogged saliva trap or air leaks in the system may cause Sip-N-Puff not to function properly.

- Ensure moving parts of the wheelchair, including the operation of powered seating, DO NOT pinch or damage the Sip-N-Puff tubing.
- Saliva trap MUST be installed to reduce risk of water or saliva entering the Sip-N-Puff interface module.
- Flush the mouthpiece and the breath tube at least twice a week with warm running water. Disinfect with oral rinse after cleaning.
- The mouthpiece MUST be completely dry before installation.
- If Sip-N-Puff does not function properly, inspect system for blockages, clogged saliva trap or air leaks. As necessary, replace mouthpiece, breath tube and saliva trap.

 For further maintenance and cleaning instructions, refer to *5 Maintenance, page 91*.

 Sip and Puff is not the most manoeuvrable or intuitive control method and therefore requires a considerable amount of training. In the early tuning stages, this is best done outdoors in an unrestricted but safe area. Also the presence of an attendant is recommended.

Inside the Head Array pads, there are proximity sensors, that allow you to steer the wheelchair in the desired direction with the movement of your head. This means that the head does not need to touch the pads or press a switch to activate driving. If the head comes within 6 mm of a sensor, the sensor is activated and the wheelchair starts driving.

By default, the Head Array powers up as soon as the wheelchair is powered up and powers down as soon as the wheelchair is powered down.

 Be aware, that when powering up automatically with the wheelchair, your head has to be more than 6 mm away from the proximity sensors, otherwise a drive OON warning is displayed and prevents the wheelchair from driving. For more information about OON, refer to *6.2 OON (“Out Of Neutral”), page 93*.

## Driving

This component combines simple sip and puff controls with head movements. Right and left turns are controlled by sensors located in the pads of the Head Array.

The drive function cards for the Sip-N-Puff are pre-set in latched driving mode. For more information, refer to *4.9 Latched Driving Mode, page 37*.

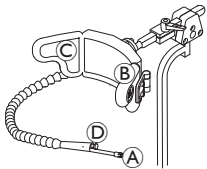

1. Puff into mouthpiece **A** to drive forwards.
2. Sip at mouthpiece **A** to drive in reverse.
3. When in latched driving mode, activate left pad **B** to veer to the left.
4. When in latched driving mode, activate right pad **C** to veer to the right.

 To revolve, you only need to activate left or right pad.

## Stopping

A lipswitch **D** is mounted to the mouthpiece. This switch can be used as an external stop switch, when in latched driving mode. While you are in latched driving, you do not need to give a drive demand all the time, but the mouthpiece must stay inside your mouth. As soon as the lipswitch is pressed while driving, the wheelchair stops.

## Changing Function Cards

The lipswitch can also be used as a mode function switch.



For difference between function card and profile, refer to 2.2.3 *User Function Card Overview*, page 8.

1. Stop wheelchair.
2. Short press lipswitch to change function card.
3. Long press lipswitch to change profile.



Seating functions can only be operated with the right or left pad of the head array.

### 4.20.7 Using the Head Array



#### **WARNING!**

#### **Risk of serious injury**

Proximity sensors are sensitive to water. If enough water is present close to sensors, they may be activated and power wheelchair may start moving unintentionally.

- Do not operate Head Array with wet hair.
- Do not operate Head Array in wet weather.
- Do not operate Head Array in any circumstances where water may come close to sensors.



#### **WARNING!**

#### **Risk of serious injury**

Sensor pads are made of water resistant vinyl to get water quickly run off the pads before activating sensors.

If sensor pads are damaged, water may get in and power wheelchair may start driving unintentionally.

If sensor pads are covered by water absorbing material, power wheelchair may start driving unintentionally.

- Do not operate Head Array if sensor pads are damaged. Change sensor pads immediately.
- Do not cover sensor pads with any material.

The Head Array is a three-quadrant operation. Inside the Head Array pads, there are proximity sensors, that allow you to steer the wheelchair in the desired direction with the movement of your head. This means that the head does not need to touch the pads or press a switch to activate driving. If the head comes within 6 mm of a sensor, the sensor is activated and the wheelchair starts driving.

By default, the Head Array powers up as soon as the wheelchair is powered up and powers down as soon as the wheelchair is powered down.

 Be aware, that when powering up automatically with the wheelchair, your head has to be more than 6 mm away from the proximity sensors, otherwise a drive OON warning is displayed and prevents the wheelchair from driving. For more information about OON, refer to 6.2 OON (“Out Of Neutral”), page 93.

## Driving

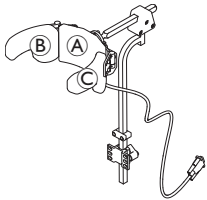

1. Activate forward drive function card.  
Activate centre pad **A** to drive forwards.
2. Change to reverse drive function card.  
Activate centre pad **A** to drive in reverse.
3. Change back to forward drive function card.  
Activate centre pad **A** and right pad **B** at the same time to veer to the right.
4. Activate centre pad **A** and left pad **C** at the same time to veer to the left.

Indicators for forward and reverse are shown in the display.

Forward drive function card

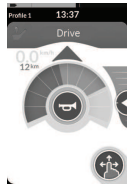

Forward active

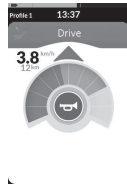

Reverse drive function card



Reverse active

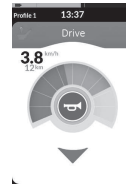

 To revolve, you only need to activate left or right pad.

## Changing Function Cards

 For difference between function card and profile, refer to *2.2.3 User Function Card Overview, page 8*.

1. Short press mode switch to change function card.
2. Long press mode switch to change profile.



Seating functions can only be operated with the right or left pad of the head array.

### 4.20.8 Using the Four Switch Proximity Array



#### **WARNING!**

#### **Risk of serious injury**

Proximity sensors are sensitive to water. If enough water is present close to sensors, they may be activated and power wheelchair may start moving unintentionally.

- Do not operate Four Switch Proximity Array in wet weather.
- Do not operate Four Switch Proximity Array in any circumstances where water may come close to sensors.

The Four Switch Proximity Array is a three-quadrant operation. The Four Switch Proximity Array offers four proximity sensors that allow to operate a power wheelchair or change the function cards. The sensors are activated, as soon as an input comes within 6 mm of the sensors.

By default, the sensors power up as soon as the wheelchair is powered up and power down as soon as the wheelchair is powered down.

 Be aware, that when powering up automatically with the wheelchair, you must not cover the proximity sensors, otherwise a drive OON warning is displayed and prevents the wheelchair from driving. For more information about OON, refer to *6.2 OON ("Out Of Neutral"), page 93*.

 The picture below shows a configuration example in combination with an Eclipse Tray. For individual adjustment, contact your provider.

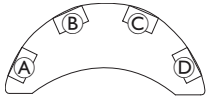

1. Cover sensor ② to drive forwards.
2. To drive in reverse, cover sensor ④ to change direction.  
Cover sensor ② to drive in reverse.
3. Cover sensors ① and ② to veer to the left.
4. Cover sensors ③ and ② to veer to the right.
5. Cover sensor ④ to change function card.

Indicators for forward and reverse are shown in the display.

Forward drive function card

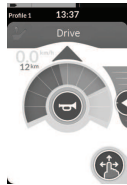

Forward active

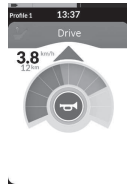

Reverse drive function card



Reverse active



 To revolve, you only need to cover sensors ① or ③.

#### 4.20.9 Using the Remote Stop Switch

The Remote Stop Switch allows a wheelchair to be stopped within a range of approximately six meters (20 feet).

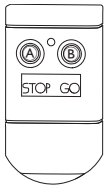

1. Press the STOP button ① to stop wheelchair.
2. Press GO button ② to allow wheelchair to move again.

 In case you lose the remote and the wheelchair cannot be operated, disconnect the jack plug of the Remote Stop Switch box from the power module.









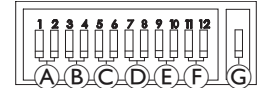





#### 4.20.10 Using the Wireless Mouse Emulator















1. Turn on the Bluetooth on your proton box by pressing an external switch until you hear a long beep.
2. Connect the Wireless Mouse Emulator via the USB port with your computer.
3. Mouse emulator and Head Array connect automatically.
4. Default set up is:

- Back pad:  
Mouse moves up and down
- Right pad:  
Mouse moves left and right
- Left pad:  
select



Mouse movement and behaviour can be changed via the switches at the back of the Wireless Mouse Emulator.

Ⓐ	Dip switch 1 & 2: Initial mouse movement			
	 slow	 medium slow	 medium fast	 fast
This is a slower speed initially for precise targeting. It is set and used in conjunction with Cursor Delay to give the user the ability to move the mouse slowly at first and then speed up after a set amount of time to move across the screen efficiently.				
Ⓑ	Dip switch 3 & 4: Maximum cursor or mouse speed			
	 disabled	 2x base	 4x base	 8x base
This setting controls the maximum speed of the cursor and is the speed that the mouse will obtain after the initial speed. Note: The base speed is set in the control panel of the computer's mouse settings.				
Ⓒ	Dip switch 5 & 6: Cursor delay			
	 disabled	 1.0 sec	 2.0 sec	 4.0 sec

<p>This is the initial amount of time the switch must be pressed and held before the mouse speeds up. This setting is used in conjunction with Initial Mouse Movement and Maximum Cursor settings.</p>				
Ⓓ	Dip switch 7 & 8: Switch delay			
	 disabled	 0.5 sec	 1.0 sec	 2.0 sec
<p>This setting controls the amount of time the directional switches must be activated before the cursor will move. This is to allow for inadvertent switch closures. Note: This applies to directional switches only.</p>				
Ⓔ	Dip switch 9 & 10: Latch delay			
	 disabled	 1.0 sec	 2.0 sec	 4.0 sec
<p>This setting controls the amount of time the Left and Right Click switch must be held before it will latch. Once the latch is no longer required, press the Right Click or Left Click switch for the same length of time to deactivate the latch.</p>				
Ⓕ	Dip switch 11 & 12: Cursor movement options			
	 3 switch	 4 switch	 4 switch	 5 switch
<p>Switch 11 and 12 should be in the DOWN position when using with the Head Array for 3 switch mouse emulation.</p>				
Ⓖ	 OFF	 ON		
	<p>OFF: Original mouse speed, better for PC. ON: Increases mouse speed by 1/3, better for MAC.</p>			

Numbers 0 to 6 describe the action the mouse should perform.  
Letters Ⓐ to Ⓕ describe the direction of the input, which leads to the mouse action.

	Number	Mouse action		Input direction	Mouse action
	0	No change	Ⓐ	Reverse	No change
	1	Down	Ⓑ	Left	Left and right mouse direction
	2	Left	Ⓒ	Right	Up and down mouse direction
	3	Right	Ⓓ	Forward	Left click
	4	Up	Ⓔ	Left click	No change
	5	Right click	Ⓕ	Right click	No change
	6	Left click			

The following adjustments are examples only and can be adjusted to your needs by your provider.



Input direction / Mouse action (0–6) cannot be duplicated in any two switches, except for zero.

## 4.21 Disabling Bluetooth

The embedded Bluetooth functionality can be disabled when powering up the system.



1. Press and hold the ON/OFF key for more than three seconds.

The disabled Bluetooth functionality is indicated by an icon in the status bar and the status LED inside the ON/OFF key pulsing for a duration of six seconds.

Bluetooth functionality resumes the next time the system is powered up again.

## 4.22 Charging the Batteries



### WARNING!

#### Risk of Injury, Damage or Death

Improper routing of charger cord(s) may cause tripping, entanglement or strangulation hazard that may result in injury, damage or death.

- Ensure all charger cord(s) are routed and secured properly.
- Close supervision and attention is needed when charging the wheelchair near children, pets or people with physical / mental disabilities.



Please cycle the power prior to charging if wheelchair has not been used within 24 hours. This will ensure the enhanced battery gauge registers the charge to give an accurate reading during use of wheelchair.

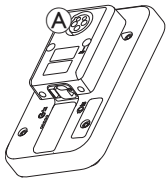

1. Plug battery charger into remote's charger socket (A).

If remote is powered up, battery gauge indicates that system is connected to charger by displaying a charge sequence and then displaying the approximate battery charge state at the end of charge sequence.



Battery bar displays red when charge is < 20 %



Battery bar displays orange when charge is between 20 % and 60 %



Battery bar displays green when charge is between 60 % and 100 %

### Battery Synchronisation



**NEW Batteries Only**—The wheelchair power must be on during charging to ensure that accurate battery charge levels display on the remote. New batteries must be charged fully. The Battery synchronization Procedure **MUST** be performed within 24 hours of powering on the wheelchair. The Battery synchronization procedure can be found in the LiNX service manual and must be performed by a provider or qualified technician.

### 4.22.1 Battery alarms

Three battery alarms are shown on the right-hand side of the status bar:



This is displayed if the batteries are overcharged. Disconnect the battery charger immediately.



This is displayed if the batteries are empty. Power down the wheelchair and charge the batteries immediately.



This is displayed if the battery voltage falls below the voltage set by Cut Off Voltage. This indicates that the battery is empty and battery damage occurs if the battery is discharged any further. The horn also sounds once every ten seconds for the duration of active deep discharge status. Power down the wheelchair and charge the batteries immediately.

## 4.23 Using the USB charger



### CAUTION! Risk of injury

If you use mobile phone while operating power wheelchair, accidents could lead to injury or property damage.

- Only use mobile phone in conjunction with hands-free equipment to operate power wheelchair while driving.





### NOTICE!

Handle USB charger with care, otherwise damage could occur.

- Always keep the USB charger dry. If USB charger gets wet, let USB charger dry before use.
- Do not use or store USB charger in dusty or dirty areas.
- Do not insert sharp objects into the USB ports.

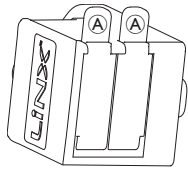
With the USB charger you can charge the battery of your mobile phone or a compatible device when you do not have access to a regular power source. Both USB ports can be used at the same time and each USB port has a charging current up to 1 A.



1. Open bung .
2. Connect device with USB port.



Close bung when USB ports are not in use.



The usage of the USB charger influences the drive range of the power wheelchair. For more information about the drive range, refer to chapter Technical Data in the user manual of your power wheelchair.

## 5 Maintenance

### ! NOTICE!

Improper mounting or maintenance of Sip-N-Puff control may cause damage to input module by water or saliva.

- Mouthpiece and breath tube **MUST** be completely dry before installation.

### 5.1 Replacing Mouthpiece

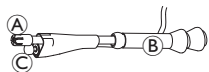

1. Remove mouthpiece **A** from gooseneck **B**.  
Make sure to leave lipswitch **C** in shrink sleeving which keeps together lipswitch and mouthpiece.
2. Insert new mouthpiece.

### 5.2 Replacing Saliva Trap

### ! NOTICE!

If saliva trap is inserted wrong way round, input module can get damaged by water or saliva.

- Make sure to insert saliva trap in correct orientation.
- Saliva trap **MUST** be installed to reduce risk of water or saliva entering input module.

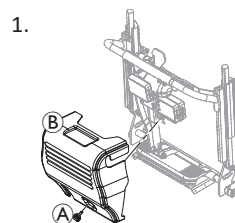

1. Remove screw / hand screw **A** and backrest shroud **B**.

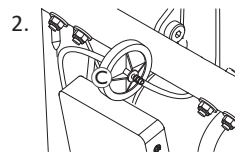

2. Remove saliva trap **C** from tube.

3. Insert new saliva trap with *INLET* imprinting facing towards input module.

### 5.3 Cleaning Sip-N-Puff

Cleaning at least twice a week is recommended.

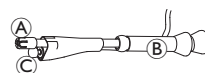

1. Remove mouthpiece **A** and lipswitch **C** from gooseneck **B**.

2. Remove breath tube from saliva trap, refer to 5.2 *Replacing Saliva Trap*, page 91.
3. Position catch can beneath breath tube to collect water and rinse.
4. Flush mouthpiece and breath tube with warm running water.
5. Rinse with oral rinse to disinfect.
6. Let dry completely before installation.
7. Install mouthpiece, lipswitch and breath tube.

## 6 Troubleshooting

### 6.1 Fault Diagnosis

If the electronic system shows a fault, use the following fault-finding guide to locate the fault.



Ensure that the drive electronics system is powered up before starting any diagnosis.

#### If the Status Display is OFF:

- Check whether the drive electronics system is powered up.
- Check whether all cables are correctly connected.
- Ensure that the batteries are not discharged.

#### If a Fault Number is Displayed in the Status Display:

- Proceed to the next section.

#### 6.1.1 Fault Codes and Diagnosis Codes

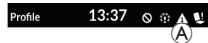

If there is a fault with the system when it is powered up, a fault icon (A) is displayed in the status bar. The number inside the triangle indicates the type of fault.



Corresponding to that, the status LED inside the ON/OFF key flashes red. The number of flashes is identical to the one in the status bar.

The table below describes the fault indication and a few possible actions that can be taken to rectify the problem. The actions listed are not in any particular order and are suggestions only.

The intention is that one of the suggestions may help you clear the problem. If in doubt, contact your provider.

Fault icon	Fault Description	Possible action
	Remote fault	<ul style="list-style-type: none"> <li>• Check cables and connectors.</li> <li>• Contact your provider.</li> </ul>
	Network or configuration fault	<ul style="list-style-type: none"> <li>• Check cables and connectors.</li> <li>• Recharge the batteries.</li> <li>• Check charger.</li> <li>• Contact your provider.</li> </ul>
	Motor 1 <sup>1</sup> fault	<ul style="list-style-type: none"> <li>• Check cables and connectors.</li> <li>• Contact your provider.</li> </ul>
	Motor 2 <sup>1</sup> fault	
	Left magnetic brake fault	<ul style="list-style-type: none"> <li>• Check cables and connectors.</li> <li>• Check if magnetic brake is engaged.</li> <li>• Refer to the chapter “Pushing the Power Wheelchair in Freewheel Mode” in the user manual of your wheelchair.</li> <li>• Contact your provider.</li> </ul>
	Right magnetic brake fault	



Fault icon	Fault Description	Possible action
	Module fault (other than remote module)	<ul style="list-style-type: none"> <li>• Check cables and connectors.</li> <li>• Check modules.</li> <li>• Recharge batteries.</li> <li>• If the chair was stalled, reverse away or remove obstacle.</li> <li>• Contact your provider.</li> </ul>

1 Configuration of the motors depending on the wheelchair model

## 6.2 OON (“Out Of Neutral”)

OON (“Out Of Neutral”) is a safety feature that prevents accidental operation of power wheelchair functions when the system’s primary input is in an out of neutral position.

For proportional joysticks, an out of neutral position is when the joystick is outside or greater than the neutral window. For discrete (switch) joysticks, an out of neutral position is when the joystick is outside or greater than the switch threshold. For switches, out of neutral is when one or more switches are activated.

An OON indication is displayed when the primary input is out of neutral and one of the following occurs:

- the system is powering up,
- after a function change,
- when the system comes out of an inhibit or drive lock-out,
- when the settings menu is exited,
- when indirect navigation is exited,

- when Rest is exited or
- on Live Handover.



OON activation is slightly different between a drive function and a non-drive function for quadrants that have no programmed output.

- For non-drive functions, such as seating, OON is not activated if the primary input is in an out of neutral position in a quadrant, that has not been programmed for an output. This is particularly useful, for example, for Head Array users who may have just the left and right pads programmed for output, allowing to rest the head on the middle pad without activating an OON.
- For drive functions, no matter how the quadrants are programmed, OON is always activated when the primary input is out of neutral when powering up or when waking from sleep.

### Drive OON Warning

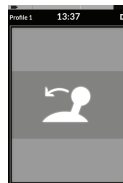

During a drive OON warning, the OON overlay is displayed and the wheelchair does not drive. If the primary input is returned to neutral position, the warning clears and the wheelchair drives normally.

## Seating OON Warning



During a seating OON warning, the OON overlay is displayed and the seating motions do not operate. If the primary input is returned to neutral position, the warning clears and the seating motions operate normally.



## Utility OON Warning

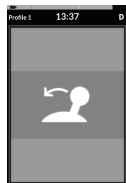

During a utility OON warning, the OON overlay is displayed and utility functions do not operate. If the primary input is returned to neutral position, the warning clears and the utility functions operate normally.

## 7 Technical Data

### 7.1 Technical Specifications

Mechanical Specifications	
Permissible Operating, Storage and Humidity Conditions	
Temperature range for operation according to ISO 7176-9:	<ul style="list-style-type: none"> <li>• -25° ... +50 °C</li> </ul>
Recommended storage temperature:	<ul style="list-style-type: none"> <li>• 15 °C</li> </ul>
Temperature range for storage according to ISO 7176-9:	<ul style="list-style-type: none"> <li>• -40° ... +65 °C</li> </ul>
Operation humidity range according to ISO 7176-9:	<ul style="list-style-type: none"> <li>• 0 ... 90 %RH</li> </ul>
Degree of protection:	<ul style="list-style-type: none"> <li>• IPX4<sup>1</sup></li> </ul>

<sup>1</sup> IPX4 classification means that the electrical system is protected against spray water.

Operating Forces	
Power button	<ul style="list-style-type: none"> <li>• 2.5 N</li> </ul>

Electrical Specifications				
Parameter	Min.	Nominal	Max.	Units
Operating voltage (Vbatt)	<ul style="list-style-type: none"> <li>• 17</li> </ul>	<ul style="list-style-type: none"> <li>• 24</li> </ul>	<ul style="list-style-type: none"> <li>• 34</li> </ul>	<ul style="list-style-type: none"> <li>• V</li> </ul>
Idle current	-	<ul style="list-style-type: none"> <li>• 70</li> </ul>	-	<ul style="list-style-type: none"> <li>• mA at 24V</li> </ul>
Quiescent current (power off)	-	-	<ul style="list-style-type: none"> <li>• 0.23</li> </ul>	<ul style="list-style-type: none"> <li>• mA at 24V</li> </ul>

**Australia:**

Invacare Australia Pty. Ltd.  
Unit 18/12 Stanton Road,  
Seven Hills, NSW 2147,  
Australia  
Phone: 1800 460 460  
Fax: 1800 814 367  
orders@invacare.com.au  
www.invacare.com.au

**EU Export:**

Invacare Poirier SAS  
Route de St Roch  
F-37230 Fondettes  
Phone: (33) (0) 2 47 62 69 80  
serviceclient\_export@invacare.com  
www.invacare.eu.com

**Canada**

Invacare Canada LP  
c/o Motion Concepts Canada  
84 Citation Drive Unit 11  
Concord, Ontario L4K 3C1

**New Zealand:**

Invacare New Zealand Ltd  
4 Westfield Place, Mt Wellington  
1060  
New Zealand  
Phone: 0800 468 222  
Fax: 0800 807 788  
sales@invacare.co.nz  
www.invacare.co.nz

**United Kingdom & Ireland:**

Invacare Limited  
Pencoed Technology Park, Pencoed  
Bridgend CF35 5AQ  
Phone: (44) (0) 1656 776 200  
uk@invacare.com  
www.invacare.co.uk

---

**UKRP** Invacare UK Operations Limited  
Unit 4, Pencoed Technology Park, Pencoed  
Bridgend CF35 5AQ  
UK

1637425-K 2024-10-15



**Making Life's Experiences Possible®**



**Yes, you can.®**