

Invacare® Stream Series

en Power Wheelchair User Manual



This manual **MUST** be given to the user of the product.
BEFORE using this product, this manual **MUST** be read and saved for
future reference.



Yes, you can.®

© 2020 Invacare Corporation

All rights reserved. Republication, duplication or modification in whole or in part is prohibited without prior written permission from Invacare. Trademarks are identified by ™ and ®. All trademarks are owned by or licensed to Invacare Corporation or its subsidiaries unless otherwise noted.

Making Life's Experiences Possible is a registered trademark in the U.S.A.

BraunAbility is a registered trademark of BraunAbility.

Contents

1 General	5
1.1 Introduction	5
1.2 Symbols in This Manual	5
1.3 Compliance	5
1.3.1 Product-Specific Standards	6
1.4 Usability	6
1.5 Warranty Information	6
1.6 Service Life	7
1.7 Limitation of Liability	7
2 Safety	8
2.1 General Safety Notes	8
2.2 Safety Information on the Electrical System	11
2.3 Safety Information on Electromagnetic Interference	13
2.4 Safety information on driving and freewheel mode	14
2.5 Safety Information With Regard to Care and Maintenance	17
2.6 Safety Information Regarding Changes and Modifications to the Mobility Device	18
3 Product Overview	21
3.1 Intended Use	21
3.2 Indications	21
3.3 Type Classification	21
3.4 Labels on Product	21
3.5 Main parts of the wheelchair	23
3.6 User Inputs	23
4 Accessories	24
4.1 Posture Belts	24
4.1.1 Types of Posture Belts	24
4.1.2 Adjusting Posture Belt Correctly	24
4.2 Using Cane Holder	25

5 Setup	26
5.1 General Setup Information	26
5.2 Adjustment Possibility for Remote	27
5.2.1 Adjusting Remote for Length of User's Arm	28
5.2.2 Adjusting Remote Height (only for Swing-Away Remote Supports)	28
5.2.3 Swivelling Remote to Side	28
5.3 Adjusting Armrest Height	28
5.4 Adjusting width of armrests	29
5.5 Adjusting the seat angle / seat height	29
5.5.1 Manual adjustment using perforated plates	29
5.6 Adjusting Backrest	31
5.6.1 Adjusting backrest angle using perforated plate	31
5.7 Adjusting Rea Headrest	32
5.7.1 Adjusting Position of Rea Headrest or Neckrest	32
5.7.2 Adjusting Height of Rea Headrest or Neckrest	33
5.8 Adjusting/Removing Tray	33
5.8.1 Adjusting Tray Laterally	33
5.8.2 Adjusting Depth of Tray/Removing Tray	34
5.8.3 Swinging Tray Away to Side	34
5.9 Standard 80° footrest (type Stream)	34
5.9.1 Swivel the legrest outward and/or remove	34
5.9.2 Adjusting the length	34
5.10 Standard 80° Legrest	35
5.10.1 Swivelling and/or Removing Legrests (Standard 80° Legrest)	35
5.10.2 Adjusting Length (Standard 80° Legrest)	35
5.11 Manually Height-Adjustable Legrest	36
5.11.1 Swivelling and/or Removing Legrests (Manually Height Adjustable)	36
5.11.2 Adjusting Legrest Angle (Manually Height Adjustable)	36
5.11.3 Adjusting Legrest Length (Manually Height Adjustable)	37
5.11.4 Adjusting Calf Pad Depth (Manually Height Adjustable)	37

5.11.5	Adjusting Calf Pad Height (Manually Height Adjustable)	38	8.4	Transporting Mobility Device Without Occupant	55
6	Usage	39	9	Maintenance	56
6.1	Driving	39	9.1	Maintenance Introduction	56
6.2	Before Driving for First Time	39	9.2	Inspection Checks	56
6.3	Parking and Stationary	39	9.2.1	Before Each Use of Mobility Device	56
6.4	Getting in and out of Mobility Device	39	9.2.2	Weekly	57
6.4.1	Removing Standard Armrest for Side Transfer	39	9.2.3	Monthly.	57
6.4.2	Information About Getting in and out.	40	9.3	Wheels and Tyres	58
6.5	Taking Obstacles	41	9.4	Short-Term Storage	58
6.5.1	Maximum Obstacle Height	41	9.5	Long-Term Storage	59
6.5.2	Safety Information When Taking Obstacles	41	9.6	Cleaning and Disinfection	59
6.5.3	Correct Way to Take Obstacles	41	9.6.1	General safety information	59
6.6	Driving up and down gradients	42	9.6.2	Cleaning Intervals.	60
6.7	Use on Public Roads	43	9.6.3	Cleaning	60
6.8	Pushing the mobility device in freewheel mode	43	9.6.4	Disinfection	61
6.8.1	Disengaging Motors	43	10	After Use	62
7	Controls System	45	10.1	Reconditioning	62
7.1	Controls Protection System	45	10.2	Disposal	62
7.2	Batteries	45	11	Technical Data	63
7.2.1	General Information on Charging	45	11.1	Technical specifications	63
7.2.2	General Instructions on Charging	45	12	Service.	67
7.2.3	Charging Batteries	46	12.1	Inspections Performed	67
7.2.4	Disconnecting Mobility Device After Charging	47			
7.2.5	Storage and Maintenance.	47			
7.2.6	Instructions on Using Batteries	47			
7.2.7	Transporting Batteries	48			
7.2.8	General Instructions on Handling Batteries	48			
7.2.9	Handling Damaged Batteries Correctly	48			
8	Transport	50			
8.1	General Information on Transport	50			
8.2	Transferring Mobility Device to Vehicle	50			
8.3	Using Mobility Device as Vehicle Seat	51			
8.3.1	How the mobility device is tied down in a vehicle	53			
8.3.2	Securing User in Mobility Device	53			

1 General

1.1 Introduction

This user manual contains important information about the handling of the product. To ensure safety when using the product, read the user manual carefully and follow the safety instructions.

Note that there may be sections in this document, which are not relevant to your product, since this document applies to all available models (on the date of printing). If not otherwise stated, each section in this document refers to all models of the product.

The models and configurations available in your country can be found in the country-specific sales documents.

Invacare reserves the right to alter product specifications without further notice.

Before reading this document, make sure you have the latest version. You find the latest version as a PDF on the Invacare website.

If you find that the font size in the printed document is difficult to read, you can download the PDF version from the website. The PDF can then be scaled on screen to a font size that is more comfortable for you.

For more information about the product, for example product safety notices and product recalls, contact your Invacare distributor. See addresses at the end of this document.

In case of a serious incident with the product, you should inform the manufacturer and the competent authority in your country.

1.2 Symbols in This Manual

Symbols and signal words are used in this manual and apply to hazards or unsafe practices which could result in personal injury or property damage. See the information below for definitions of the signal words.



WARNING

Indicates a hazardous situation that could result in serious injury or death if it is not avoided.



CAUTION

Indicates a hazardous situation that could result in minor or slight injury if it is not avoided.



IMPORTANT

Indicates a hazardous situation that could result in damage to property if it is not avoided.



Tips

Gives useful tips, recommendations and information for efficient, trouble-free use.



Tools

Identifies required tools, components and items which are needed to carry out certain work.

1.3 Compliance

Quality is fundamental to the company's operation, working within the disciplines of ISO 13485.

This product features the CE mark, in compliance with the Medical Device Regulation 2017/745 Class I. The launch date of this product is stated in the CE declaration of conformity.

We are continuously working towards ensuring that the company's impact on the environment, locally and globally, is reduced to a minimum.

We only use REACH compliant materials and components.

We comply with the current environmental legislations WEEE and RoHS.

1.3.1 Product-Specific Standards

The product has been tested and conforms to DIN EN 12184 (Electrically powered wheelchairs, scooters and their chargers) and all related standards.

When equipped with an appropriate lighting system, the product is suitable for use on public roads.

For further information about local standards and regulations, contact your local Invacare distributor. See addresses at the end of this document.

1.4 Usability

Only use a mobility device when it is in perfect working order. Otherwise, you might put yourself and others at risk.

The following list does not claim to be exhaustive. It is only intended to show some of the situations that could affect the usability of your mobility device.

In certain situations, you should immediately stop using your mobility device. Other situations allow you to use the mobility device to get to your provider.

You should immediately stop using your mobility device if its usability is restricted due to:

- Unexpected driving behaviour
- brake failure

You should immediately contact an authorised Invacare provider if the usability of your mobility device is restricted due to:

- the lighting system (if fitted) failing or being defective
- reflectors falling off
- worn thread or insufficient tire pressure
- damage to the armrests (e.g. torn armrest padding)
- damage to the legrest hangers (e.g. missing or torn heel straps)
- damage to the postural belt
- damage to the joystick (joystick cannot be moved into the neutral position)
- cables that are damaged, kinked, pinched or have come loose from the fixation
- the mobility device drifting when braking
- the mobility device pulling to one side when moving
- unusual sounds developing or occurring

Or if you have the feeling that something is wrong with your mobility device.

1.5 Warranty Information

We provide a manufacturer's warranty for the product in accordance with our General Terms and Conditions of Business in the respective countries.

Warranty claims can only be made through the provider from whom the product was obtained.

1.6 Service Life

We estimate a service life of five years for this product, provided it is used in strict accordance with the intended use as set out in this document and all maintenance and service requirements are met. The estimated service life can be exceeded if the product is carefully used and properly maintained, and provided technical and scientific advances do not result in technical limitations. The service life can also be considerably reduced by extreme or incorrect usage. The fact that we estimate a service life for this product does not constitute an additional warranty.

1.7 Limitation of Liability

Invacare accepts no liability for damage arising from:

- Non-compliance with the user manual
- Incorrect use
- Natural wear and tear
- Incorrect assembly or set-up by the purchaser or a third party
- Technical modifications
- Unauthorised modifications and/or use of unsuitable spare parts

2 Safety

2.1 General Safety Notes



DANGER!

Risk of Death, Serious Injury, or Damage

Lighted cigarettes dropped onto an upholstered seating system can cause a fire resulting in death, serious injury, or damage. Mobility device occupants are at particular risk of death or serious injury from these fires and resulting fumes because they may not have the ability to move away from the mobility device.

- DO NOT smoke while using this mobility device.



WARNING!

Risk of Injury, Damage or Death

Improper monitoring or maintenance may cause injury, damage or death due to ingestion or choking on parts or materials.

- Closely supervise children, pets, or people with physical/mental disabilities.



WARNING!

Risk of Death, Serious Injury or Damage

Improper routing of cables may cause a tripping entanglement or strangulation hazard that may result in death, serious injury or damage.

- Ensure all cables are routed and secured properly.
- Ensure there are no loops of excess cable extending away from the wheelchair.



WARNING!

Risk of Serious Injury or Damage

Improper use of this product may cause injury or damage.

- If you are unable to understand the warnings, cautions or instructions, contact a health care professional or provider before attempting to use this equipment.
- Do not use this product or any available optional equipment without first completely reading and understanding these instructions and any additional instructional material such as user manual, service manual or instruction sheet supplied with this product or optional equipment.

**WARNING!**

Risk of injury if the mobility device is driven when ability to operate a vehicle is impaired by medication or alcohol

- Never drive the mobility device under the influence of medication or alcohol. If necessary, the mobility device must be operated by an attendant who is physically and mentally able.

**WARNING!**

Risk of damage or injury if mobility device is accidentally set into motion

- Switch the mobility device off before you get in, get out or handle unwieldy objects.
- When the drive is disengaged, the brake inside the drive is deactivated. For this reason, pushing the mobility device by an attendant is only recommended on flat surfaces, never on gradients. Never leave your mobility device on a gradient with its motors disengaged. Always re-engage the motors immediately after pushing the mobility device (refer to Pushing the mobility device in freewheel mode).

**WARNING!**

Risk of injury if the mobility device is switched off while driving, for example by pressing the On/Off Button or disconnecting a cable, due to it coming to an abrupt, sharp stop

- If you have to brake in an emergency, simply release the joystick which will bring you to a halt (refer to the remote user manual for more information).

**WARNING!**

Risk of injury when transferring mobility device to a vehicle for transport with the occupant seated in it

- It is always better to transfer the mobility device to a vehicle without the occupant seated in it.
- If the mobility device needs to be loaded up a ramp together with its driver, ensure that the ramp does not exceed the rated slope (refer to *11 Technical Data, page 63*).
- If the mobility device does need to be loaded using a ramp which exceeds the rated slope (refer to *11 Technical Data, page 63*), then you must use a winch. An attendant can safely monitor and assist the loading process.
- As an alternative you can use a platform lift. Ensure that the total weight of the mobility device including the user does not exceed the maximum permissible weight for the platform lift or winch if you are using.



WARNING!

Risk of falling out of the mobility device

- Do not slide forward on the seat, do not lean forward between your knees, do not lean backwards out over the top of the backrest, for example to reach an object.
- If a posture belt is installed, it should be correctly adjusted and used each time you use the mobility device.
- When transferring to a different seat, position the mobility device as close as possible to the new seat.



WARNING!

Risk of Serious Injury or Damage

Storing or using the mobility device near open flame or combustible products can result in serious injury or damage.

- Avoid storing or using the mobility device near open flame or combustible products.



CAUTION!

Risk of injury if maximum permissible load is exceeded

- Do not exceed the maximum permissible load (refer to *11 Technical Data, page 63*).
- The mobility device is only designed for use by a single occupant whose maximum weight does not exceed the maximum permissible load of the device. Never use the mobility device to transport more than one person.



CAUTION!

Risk of injury due to wrong lifting or dropping of heavy components

- When maintaining, servicing or lifting any part of your mobility device, take into account the weight of the individual components especially the batteries. Be sure at all times to adopt the correct lifting posture and ask for assistance if necessary.



CAUTION!

Risk of injury by moving parts

- Make sure that no injury is incurred by moving parts of the mobility device, like wheels or one of the lifter modules (if fitted), especially when children are around.



CAUTION!

Risk of injury from hot surfaces

- Do not leave the mobility device in direct sunlight for prolonged periods. Metal parts and surfaces such as the seat and armrests can become very hot.

**CAUTION!****Risk of fire or breaking down due to electric devices being connected**

- Do not connect any electric devices to your mobility device that are not expressly certified by Invacare for this purpose. Have all electrical installations done by your authorized Invacare provider.

2.2 Safety Information on the Electrical System**WARNING!****Risk of death, serious injury or damage**

Misuse of the mobility device may cause the mobility device to start smoking, sparking, or burning. Death, serious injury, or damage may occur due to fire.

- DO NOT use the mobility device other than its intended purpose.
- If the mobility device starts smoking, sparking, or burning, discontinue using the mobility device and seek service IMMEDIATELY.

**WARNING!****Risk of fire**

Switched on lamps produce heat. If you cover the lamps with fabrics such as clothes, there is a risk that the fabric may catch fire.

- NEVER cover the light system with fabric.

**WARNING!****Risk of death, serious injury or damage when carrying along oxygen systems**

Textiles and other materials that normally would not burn are easily ignited and burn with great intensity in oxygen enriched air.

- Check the oxygen tubing daily, from the cylinder to the delivery site, for leaks and hold away from electrical sparks and any source of ignition.

**WARNING!****Risk of injury or damage due to electrical shorts**

Connector pins on cables connected to the power module can still be live even when the system is off.

- Cables with live pins should be connected, restrained or covered (with non-conductive materials) so that they are not exposed to human contact or materials that could cause electrical shorts.
- When cables with live pins have to be disconnected, for example, when removing the bus cable from the remote for safety reasons, make sure to restrain or cover the pins (with non-conductive materials).



WARNING!

Risk of death, serious injury, or damage

Corroded electrical components due to water or liquid exposure can result in death, serious injury, or damage.

- Minimize exposure of electrical components to water and/or liquids.
- Electrical components damaged by corrosion **MUST** be replaced immediately.
- Mobility devices that are frequently exposed to water/liquids may require replacement of electrical components more frequently.



WARNING!

Risk of death or serious injury

Failure to observe these warnings can cause an electrical short resulting in death, serious injury, or damage to the electrical system.

- The **POSITIVE (+) RED** battery cable **MUST** connect to the **POSITIVE (+)** battery terminal(s)/post(s). The **NEGATIVE (-) BLACK** battery cable **MUST** connect to the **NEGATIVE (-)** battery terminal(s)/post(s).
- **NEVER** allow any of your tools and/or battery cable(s) to contact **BOTH** battery post(s) at the same time. An electrical short may occur and serious injury or damage may occur.
- Install protective caps on positive and negative battery terminals.
- Replace cable(s) immediately if cable(s) insulation becomes damaged.
- **DO NOT** remove fuse or mounting hardware from **POSITIVE (+)** red battery cable mounting screw.



WARNING!

Risk of death or serious injury

Electric shock can cause death or serious injury

- To avoid electric shock, inspect plug and cord for cuts and/or frayed wires. Replace cut cords or frayed wires immediately.



Risk of damage to the mobility device

- A failure in the electric system can lead to unusual behavior such as continuous light, no light, or noises from the magnetic brakes.
- If a failure exists, switch off the remote and switch it on again.
 - If a failure still exists, then disconnect or remove the power source. Depending on the mobility device model, you can either remove the battery packs or disconnect the batteries from the power module. If in doubt which cable to disconnect, contact your provider.
 - In any case, contact your provider.

2.3 Safety Information on Electromagnetic Interference

This powered mobility device was successfully tested in accordance with International standards as to its compliance with Electromagnetic Interference (EMI) regulations. However, electromagnetic fields, such as those generated by radio and television transmitters, and cellular phones can influence the functions of powered mobility devices. Also, the electronics used in our mobility devices can generate a low level of electromagnetic interference, which however will remain within the tolerance permitted by law. For these reasons we ask you to please observe the following precautions:



WARNING!

Risk of malfunction due to electromagnetic interference

- Do not switch on or operate portable transceivers or communication devices (such as radio transceivers or cellular phones) when the mobility device is switched on.
- Avoid getting near strong radio and television transmitters.
- In case the mobility device should be set in motion unintentionally or the brakes are released, switch it off immediately.
- Adding electrical accessories and other components or modifying the mobility device in any way can make it susceptible to electromagnetic interference. Keep in mind that there is no sure way to determine the effect such modifications will have on the overall immunity of the electronic system.
- Report all occurrences of unintentional movement of the mobility device, or release of the electric brakes to the manufacturer.

2.4 Safety information on driving and freewheel mode



DANGER!

Risk of death, serious injury, or damage

Malfunctioning joystick could cause unintended/erratic movement resulting in death, serious injury, or damage

- If unintended/erratic movement occurs, stop using the wheelchair immediately and contact a qualified technician.

**WARNING!****Risk of injury if the mobility device tips over**

- Inclines and declines can only be travelled up to the rated slope (refer to *11 Technical Data, page 63*).
- Always return the backrest of your seat or the seat tilt to an upright position before ascending slopes. We recommend that you position the seat backrest and the seat tilt (if fitted) slightly to the rear before descending slopes.
- Only ever drive downhill at a maximum of 2/3 of the top speed. Avoid abrupt braking or accelerating on gradients.
- If at all possible, avoid driving on wet, slippery, icy, or oily surfaces (such as snow, gravel, ice etc.) where there is a risk of you losing control over the vehicle, especially on a gradient. This may include certain painted or otherwise treated wood surfaces. If driving on such a surface is inevitable, then always drive slowly and with the utmost caution.
- Never attempt to overcome an obstacle when on an uphill or downhill gradient.
- Never attempt to drive up or down a flight of steps with your mobility device.
- When overcoming obstacles, always observe the maximum obstacle height (refer to *11 Technical Data, page 63* and information about overcoming obstacles in *6.5 Taking Obstacles, page 41*).
- Avoid shifting your center of gravity as well as abrupt joystick movements and changes of direction when the mobility device is in motion.

**WARNING!****Risk of injury if the mobility device tips over (continued)**

- Never use the mobility device to transport more than one person.
- Do not exceed the overall maximum permissible load or the maximum load per axle (refer to *11 Technical Data, page 63*).
- Note that the mobility device will brake or accelerate if you change the driving mode whilst the mobility device is in motion.

**WARNING!****Risk of serious injury or damage**

- Improper positioning while leaning or bending could cause the wheelchair to tip forward resulting in serious injury or damage
- To assure stability and proper operation of your mobility device, you must at all times maintain proper balance. Your power wheelchair has been designed to remain upright and stable during normal daily activities as long as you DO NOT move beyond the center of gravity.
 - DO NOT lean forward out of the mobility device any further than the length of the armrests.
 - DO NOT attempt to reach objects if you have to move forward in the seat or pick them up from the floor by reaching down between your knees.



WARNING!

Risk of breaking down in adverse weather conditions, i.e. extreme cold, in an isolated area

- If you are a user with severely limited mobility, we advise that in the case of adverse weather conditions DO NOT attempt a journey without an accompanying attendant.



WARNING!

Risk of injury if your foot slides off the footrest and gets caught underneath the mobility device when it is in motion

- Make sure each time before you drive the mobility device that your feet are squarely and securely in place on the footplates, and that both legrests are properly locked into place.



WARNING!

Risk of serious injury or damage

Operating the mobility device with a ground clearance of less than 76 mm between the footplate and ground/floor may cause serious injury or property damage.

- ALWAYS maintain a minimum of 76 mm between the bottom of the footplate and ground/floor to ensure proper ground clearance while the mobility device is in motion. If necessary, adjust the footplate height to achieve proper ground clearance.
- After footplate height adjustment, if the mobility device dips forward and the footplates touch the ground while in motion, please contact your dealer for an inspection and avoid use of the mobility device if possible.



WARNING!

Risk of injury if you collide with an obstacle when driving through narrow passages such as doorways and entrances

- Drive through narrow passages in the lowest driving mode and with due caution.

**WARNING!****Risk of injury**

If your mobility device has been fitted with elevating legrests, there is a risk of personal injury and damage to the mobility device if you drive the mobility device with the legrests raised.

- To avoid unwanted displacement of the mobility device center of gravity to the front (especially when travelling downhill) and in order to avoid damage to the mobility device, elevating legrests must always be lowered during normal travelling.

**WARNING!****Risk of tipping**

Antitippers (stabilizers) are only effective on firm ground. They sink in on soft ground such as grass, snow or mud if the mobility device rests itself on them. They lose their effect and the mobility device can tip over.

- Only drive with extreme care on soft ground, especially during uphill and downhill journeys. In the process pay increased attention to the tip stability of the mobility device.

**WARNING!****Risk of injury or damage**

Operating the wheelchairs outdoors or in areas of poor lighting may cause injury or damage. Operating the wheelchair near motor vehicles may cause injury or damage.

- DO NOT operate on roads, streets or highways.
- Use caution when operating the wheelchair outdoors at night or in areas with poor lighting.
- ALWAYS be aware of motor vehicles when using the wheelchair.

2.5 Safety Information With Regard to Care and Maintenance

**WARNING!****Risk of death, serious injury, or damage**

Incorrect repair and/or servicing of this mobility device performed by users/caregivers or unqualified technicians can result in death, serious injury, or damage.

- DO NOT attempt to carry out maintenance work that is not described in this user manual. Such repair and/or service MUST be performed by a qualified technician. Contact a provider or Invacare technician.



CAUTION!

Risk of accident and loss of warranty if maintenance is insufficient

- For reasons of safety and in order to avoid accidents which result from unnoticed wear, it is important that this mobility device undergoes an inspection once every year under normal operating conditions (see inspection plan contained in service instructions).
- Under difficult operating conditions such as daily travel on steep slopes, or in the case of use in medical care cases with frequently changing mobility device users, it would be expedient to carry out intermediate checks on the brakes, accessories and running gear.
- If the mobility device is to be operated on public roads, the vehicle driver is responsible for ensuring that it is in an operationally reliable condition. Inadequate or neglected care and maintenance of the mobility device will result in a limitation of the manufacturer's liability.

2.6 Safety Information Regarding Changes and Modifications to the Mobility Device



WARNING!

Risk of serious injury or damage

- Use of incorrect or improper replacement (service) parts may cause injury or damage
- Replacement parts **MUST** match original Invacare parts.
 - Always provide the wheelchair serial number to assist in ordering the correct replacement parts.



CAUTION!

Risk of injuries and damage to mobility device due to unapproved components and accessory parts

Seating systems, additions and accessory parts which have not been approved by Invacare for use with this mobility device can affect the tipping stability and increase tipping hazards.

- Only ever use seating systems, additions and accessory parts which have been approved by Invacare for this mobility device.

Seating systems which are not approved by Invacare for use with this mobility device do not, under certain circumstances, comply with the valid standards and could increase the flammability and the risk of skin irritation.

- Only use seating systems that have been approved by Invacare for this mobility device.

Electrical and electronic components which have not been approved by Invacare for use with this mobility device can cause fire hazards and lead to electromagnetic damage.

- Only ever use electrical and electronic components which have been approved by Invacare for this mobility device.

Batteries which have not been approved by Invacare for use with this mobility device can cause chemical burns.

- Only ever use batteries which have been approved by Invacare for this mobility device.



CAUTION!

Risk of injuries, and damage to the mobility device, if unapproved backrests are used

A retrofitted backrest which is not approved by Invacare for use with this mobility device may overload the backrest tube and thus increase the risk of injuries and of damage to the mobility device.

- Please contact your Invacare specialist provider who will perform risk analyses, calculations, stability checks etc. to ensure that the backrest can be used safely.



CE marking of the mobility device

- The conformity assessment/CE marking was carried out according to the respective valid regulations and only applies to the complete product.
- The CE marking is invalidated if components or accessories are replaced or added that have not been approved for this product by Invacare.
- In this case, the company that adds or replaces the components or accessories is responsible for the conformity assessment/CE marking or for registering the mobility device as a special design and for the relevant documentation.



Important information about maintenance work tools

– Some maintenance work which is described in this manual and can be carried out by the user without problems require the correct tools for proper work. If you do not have the correct tool available we do not recommend that you try to carry out the relevant work. In this case, we urgently recommend that you contact an authorized specialist workshop.

3 Product Overview

3.1 Intended Use

This mobility device was designed for persons whose ability to walk is impaired, but who are still in terms of their eyesight and physically and mentally able to operate an electric mobility device.

3.2 Indications

The use of this power wheelchair is recommended for the following indications:

- The inability or a greatly restricted ability to walk within the scope of the basic requirement to be able to move within one’s own four walls.
- The need to leave the dwelling place in order to get some fresh air during a short walk or to reach those places generally to be found at close distance to the dwelling and where everyday business is carried out.

Provision of power wheelchairs for interior and exterior areas is advisable if the use of hand-operated wheelchairs is no longer possible on account of the disability, yet proper operation of an electromotive drive unit is still practicable.

Contraindications

There are no contraindications known.





3.3 Type Classification

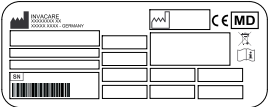

This vehicle has been classified according to EN 12184 as a **class B mobility product** (for indoor and outdoor areas). It is therefore compact and agile enough for indoor areas, but also able to overcome many obstacles in outdoor areas.

3.4 Labels on Product





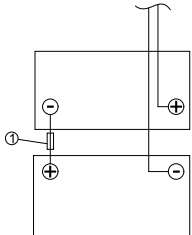







<p>(A)</p>		<p>If the mobility device is fitted with a tray, it is imperative that it is removed and safely stowed when transporting the mobility device in a vehicle.</p>
<p>(B)</p>	<p>Identification of the tie-down points at the front and back:</p> <p>ISO 7176-19</p>	<p>If the symbol appears on a bright yellow sticker, the tie-down point is suitable for fixation of the mobility device in a vehicle for use as a vehicle seat.</p>

C		<p>Identification label sticker on the chassis at the middle.</p> <p>For details see below.</p>
D		<p>Identification of the position of the coupling lever for driving and push operation (only the right side is visible in the picture).</p> <p>For details see below.</p>
E		<p>Indication of service-free wheel hub screw</p>
F	 <p>ISO 7176-19</p>	<p>Warning that the mobility device may not be used as a vehicle seat.</p> <p>This mobility device does not satisfy the requirements of ISO 7176-19.</p>

		<p>Battery wiring label with main fuse (1) under the battery cover.</p> <p>For technicians only.</p>
G		<p>Indication of pinch points that could occur on the mobility device.</p>

Explanation of Symbols on Labels

	<p>Manufacturer</p>
	<p>Date of manufacture</p>
	<p>European Conformity</p>
	<p>Medical device</p>
	<p>Serial number</p>

	<p>WEEE Conformity</p>
	<p>This symbol indicates the “Drive” position of the coupling lever. In this position the motor is engaged and the motor brakes are operational. You can drive the mobility device.</p> <ul style="list-style-type: none"> Note that for driving purposes both motors must always be engaged.
	<p>This symbol indicates the “Push” position of the coupling lever. In this position the motor is disengaged and the motor brakes are not operational. The mobility device can be pushed by an attendant and the wheels turn freely.</p> <ul style="list-style-type: none"> Note that the remote must be switched off. Also note the information provided in section 6.8 <i>Pushing the mobility device in freewheel mode</i>, page 43.
	<p>Read the user manual. This symbol appears on the identification label.</p>
	<p>Read the user manual. This symbol appears on different labels and positions.</p>

3.5 Main parts of the wheelchair



- 1 Push handle
- 2 Locking screw for adjusting armrest height
- 3 Locking screw for adjusting backrest angle
- 4 Disengaging lever
- 5 Special control unit for light
- 6 Remote
- 7 Legrest unlocking lever

3.6 User Inputs

Your mobility device may be fitted with one of several different user inputs. For information on the different functions and how to operate a particular user input, refer to its corresponding user manual (enclosed).

4 Accessories

4.1 Posture Belts

A posture belt is an option which can either be fixed to the mobility device ex-works or can be retrofitted by your specialist provider. If your mobility device is fitted with a posture belt, your specialist provider will have informed you about fitting and usage.

The posture belt is used to help the mobility device user keep an optimum seating position. Correct use of the belt assists the user in sitting securely, comfortably and well-positioned in the mobility device, especially for such users who do not have such a good sense of balance while sitting.



We recommend using the posture belt whenever the mobility device is used.

4.1.1 Types of Posture Belts

Your mobility device can be fitted with the following posture belt types ex-works. If your mobility device has been fitted with a different belt to those listed below, please ensure that you have received the manufacturer's documentation with regard to correct fitting and use.

Belts with metal buckle, adjustable one side



Belts can only be adjusted on one side which can result in the buckle not sitting centrally.

Belts with metal buckle, adjustable both sides



Belt can be adjusted on both sides. This means that the buckle can be centrally positioned.

4.1.2 Adjusting Posture Belt Correctly



The belt should be tight enough to ensure that you are sitting comfortably and that your body is in the correct sitting position.

1. Ensure that you are sitting correctly, which means that you are sitting right at back of seat, your pelvis is positioned erect and as symmetrically as possible, not to front, to side or at one edge of seat.
2. Position posture belt so that your hipbones can be easily felt above belt.
3. Adjust belt length using one of adjustment aids described above. The belt should be adjusted so that you can fit a flat hand between belt and your body.

4. Buckle should be positioned as centrally as possible. In doing so, carry out adjustments on both sides as much as possible.
5. Check your belt every week to ensure that it is still in good working condition, to ensure it has no damage or wear, and that it is fixed properly to mobility device. If belt is only fastened with a bolted connection, ensure that connection has not loosened or come undone. You can find more information about maintenance work on belts in the service manual, which is available from Invacare.

4.2 Using Cane Holder

If your mobility device is fitted with a cane holder, it can be used for the safe transport of a walking cane, underarm or forearm crutches. The cane holder consists of a plastic container (bottom) and a hook-and-loop fastener (top).



CAUTION! **Risk of Injury**

A walking cane or crutches that are not secured during transport (on the user's lap, for example) can cause injury to the user or other persons.

- During transport, walking canes or crutches should always be secured using a cane holder.

1. Open upper hook-and-loop fastener.
2. Place lower end of the walking cane or crutches in container at bottom.
3. Walking cane or crutches can be secured at upper end using hook-and-loop fastener.

5 Setup

5.1 General Setup Information

**WARNING!****Risk of Death, Serious Injury or Damage**

Continued use of the mobility device that is not set to the correct specifications may cause erratic behaviour of the mobility device resulting in death, serious injury, or damage.

- Performance adjustments should only be made by professionals of the healthcare field or persons fully conversant with this process and the driver's capabilities.
- After the mobility device has been set-up/adjusted, check to make sure that the mobility device performs to the specifications entered during the set-up procedure. If the mobility device does not perform to specifications, IMMEDIATELY turn the mobility device Off and re-enter set-up specifications. Contact Invacare, if mobility device still does not perform to correct specifications.

**WARNING!****Risk of Death, Serious Injury or Damage**

Attaching hardware that is loosely secured or missing could cause instability resulting in death, serious personal injury, or property damage.

- After ANY adjustments, repair or service and before use, make sure that all attaching hardware is present and tightened securely.

**WARNING!****Risk of Injury or Damage**

Incorrect set up of this mobility device performed by users/caregivers or unqualified technicians can result in injury or damage.

- DO NOT attempt to set up this mobility device. Initial set up of this mobility device MUST be performed by a qualified technician.
- Adjustment by the user is only recommended after they have been given appropriate guidance by the healthcare professional.
- DO NOT attempt to carry out the work if you do not have the listed tools available.

**CAUTION!****Damage to Mobility Device and Accident Hazard**

It is possible that collisions can occur between mobility device components due to various combinations of adjustment options and their individual settings.

- The mobility device is fitted with an individual, multiply adjustable seating system including adjustable legrests, armrests, a headrest or other options. These adjustment options are described in the following chapters. They are used to adapt the seat to the physical requirements and the condition of the user. When adapting the seating system and the seat functions to the user, ensure that no mobility device components collide.

! **IMPORTANT!**

The mobility device is manufactured and configured individually to the specifications of the order. The assessment must be performed by a healthcare professional according to the user's requirements and health conditions.

- Consult a healthcare professional if you intend to adapt the mobility device configuration.
- Any adaption should be performed by a qualified technician.

 Initial setup should always be done by a healthcare professional. Adjustment by the user is only recommended after they have been given appropriate guidance by the healthcare professional.

Electrical Adjustment Options

 Refer to the user manual for your remote for more information on operating electrical adjustment options.

Footplates

All footplates offered by Invacare can be folded upwards.

5.2 Adjustment Possibility for Remote

The following information is valid for all seating systems.

**CAUTION!**

Risk of the remote being pushed backwards during an accidental collision with an obstacle, such as a doorframe or table, and the joystick being jammed against the armpad if the position of the remote is adjusted and all screws are not completely tightened

This will cause the mobility device to drive forward uncontrollably and potentially injure the mobility device user and any person standing in the way.

- When adjusting the position of the remote, always make sure to tighten all screws securely.
- If this should accidentally happen, immediately switch the mobility device electronics OFF at the remote.

**CAUTION!****Risk of Injury**

When leaning on the remote, for example, when transferring into or out of the wheelchair, the remote holder may break and the user may fall out of the chair.

- Never lean on the remote as a support for, for example, transfer.

5.2.1 Adjusting Remote for Length of User's Arm

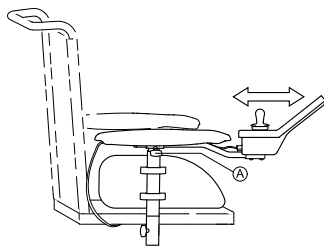

Fig. 5-1

1. Loosen wing screw (A).
2. Adjust component to desired position.
3. Tighten wing screw.

5.2.2 Adjusting Remote Height (only for Swing-Away Remote Supports)



- 6 mm Allen key

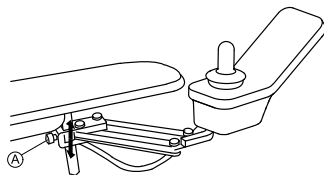

Fig. 5-2

1. Loosen screw (A).
2. Adjust component to desired position.
3. Tighten screw.

5.2.3 Swivelling Remote to Side

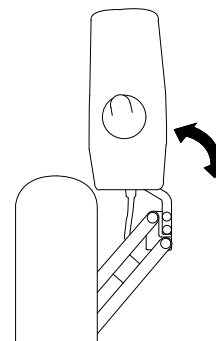

Fig. 5-3

If your mobility device is fitted with a swing-away remote holder, then the remote can be moved away to the side, for example, to drive up close to a table.

5.3 Adjusting Armrest Height

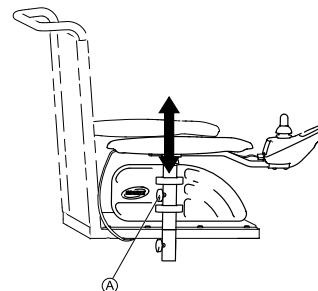

Fig. 5-4

1. Loosen wing screw (A).
2. Adjust component to desired position.
3. Tighten wing screw.

5.4 Adjusting width of armrests



WARNING!

Serious risk of injury if one of the armrests falls out of its bracket because they have been adjusted to a width which exceeds the permissible value

- The width adjustment is fitted with red markings (A) and the word "STOP". The armrests must never be pulled out further than the point at which the word "STOP" is completely legible.
- Always tighten the fixing screws properly once adjustments have been completed.

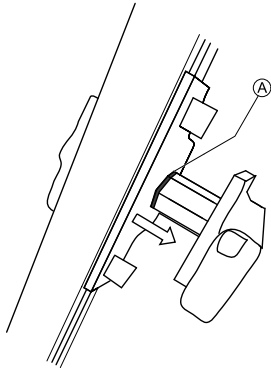

Depending on the side, the screw is accessible from the front or the rear.



- 8 mm Allen key

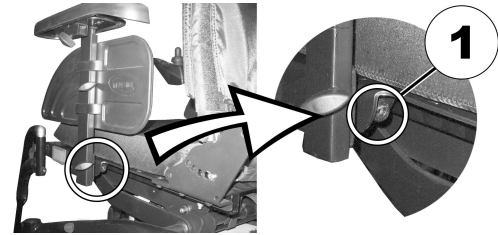

1. Loosen screw (1).
2. Adjust armrest to required position.
3. Re-tighten screw.
4. Repeat this procedure for the second armrest.

5.5 Adjusting the seat angle / seat height

5.5.1 Manual adjustment using perforated plates

There are three perforated plates underneath the seat for adjusting the seat angle and the seat height. These perforated plates in connection with the adjustable rear holding plates result in a multitude of different setting possibilities.

The adjustment range of the seat height is 42.5 cm to 50 cm. The adjustment range of the seat angle is 22°. Note: The higher the seat setting, the smaller the adjustment range of the seat angle!



- 5 mm Allen key
- 6 mm Allen key
- 13 mm wrench
- Torque wrench
- Thread locking adhesive such as Loctite medium-hard

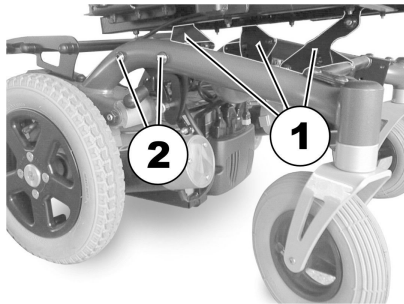

The picture above shows the position of the perforated plates (1) and the holding plate fixing screws (2) for adjusting the seat height and seat angle.



The picture above shows the front perforated plates. The procedure is similar for the rear perforated plates. A 13 mm wrench is required in addition to a 5 mm Allen key for adjusting the front perforated plates.

1. Loosen screw (1) and remove to adjust seat height/angle.
2. Adjust perforated plate to desired height/angle.
3. Apply thread locking adhesive to screw, re-insert screw and tighten to 40 Nm.

Seat height and angle can also be adjusted using the rear holding plate.

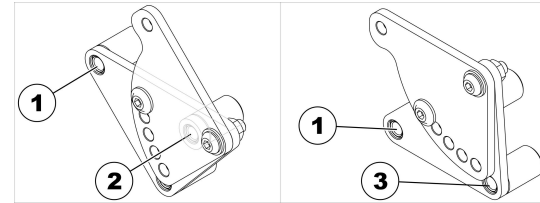

- Low setting = hole combination 1 and 2.
 - High setting = hole combination 1 and 3.
1. Loosen rear screw on one side (in bushing 1) so that holding plate can be swivelled up or down.
 2. Loosen front screw and remove. Depending on the position, the screw is either in bushing 2 or 3.
 3. Repeat procedure on other side.
 4. Apply thread locking adhesive to screw, re-insert screw and tighten to 25 Nm (+/- 3 Nm).

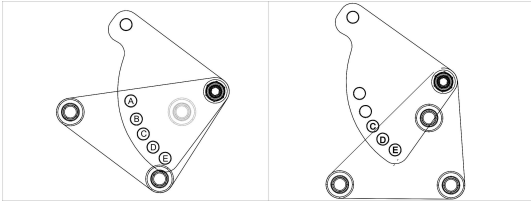

The swivelling rear perforated plates have five positions. These are labelled in the illustration above with the letters A to E.

All five positions can be used if the holding plates are in the lower position (see above). Only positions B, C, D and E are possible in the higher position! When using position A, the holding plate collides with the seat frame.

The following seat heights are available:

Holding plate in lower position:	
Position of perforated plate:	Seat height:
A	44 cm
B	45.5 cm
C	45.5 cm
D	46.5 cm
E	47 cm

Holding plate in higher position:	
Position of perforated plate:	Seat height:
B	50.5 cm (at 6° seat angle)

Holding plate in higher position:

C	48.5 cm
D	49.5 cm
E	51.5 cm

5.6 Adjusting Backrest



CAUTION!

Adjusting the seat tilt or the backrest angle changes the geometry of the mobility device and directly influences its dynamic stability!

– For details regarding dynamic stability, negotiating gradients and obstacles and the correct adjustment of seat tilt or backrest angle, refer to *6.5 Taking Obstacles, page 41* and *Driving up and down Gradients*.

5.6.1 Adjusting backrest angle using perforated plate



1. Loosen hand screws (1) on both sides.
2. Adjust backrest by choosing a combination of one of the two bore holes in the backrest frame and one of the six bore holes in the fixing plate.
3. Re-insert screws and tighten.

5.7 Adjusting Rea Headrest



CAUTION!

Risk of injury during use of the mobility device as a vehicle seat if a headrest is wrongly adjusted or not installed

This can cause the neck to be hyperextended during collisions.

- A headrest must be installed. The headrest optionally supplied for this mobility device by Invacare is perfectly suitable for use during transport.
- The headrest must be adjusted to the user's ear height.

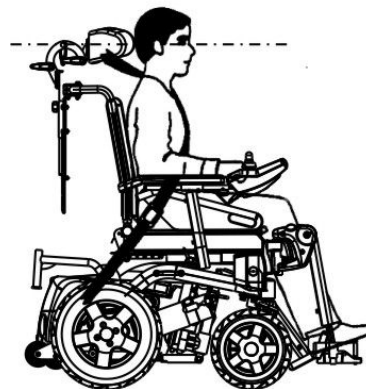

5.7.1 Adjusting Position of Rea Headrest or Neckrest

The adjustment of the position is the same for all Rea headrests and neckrests.



- 5 mm Allen key

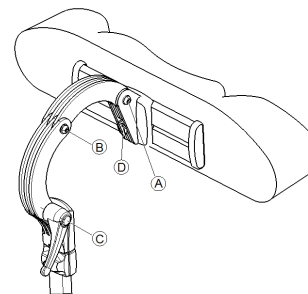

1. Loosen the screws (A) , (B) or the clamping lever (C).
2. Adjust the headrest or neckrest to the required position.
3. Retighten screws and clamping lever.
4. Loosen the Allen screw (D).
5. Slide the headrest left or right to the required position.
6. Retighten the Allen screw.

5.7.2 Adjusting Height of Rea Headrest or Neckrest

The adjustment of the height is the same for all Rea headrests and neckrests.

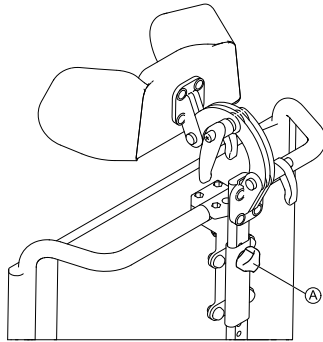

Fig. 5-5

1. Loosen hand screw (A).
2. Adjust component to desired position.
3. Tighten hand screw.

5.8 Adjusting/Removing Tray



CAUTION!

Risk of injury or material damage if a mobility device which is fitted with a tray is transported in a vehicle

– If a tray is fitted, always remove it before transporting the mobility device.



Fig. 5-6

5.8.1 Adjusting Tray Laterally

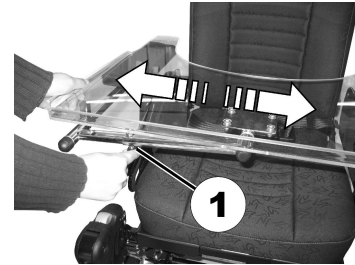

Fig. 5-7

1. Loosen wing screw (1).
2. Adjust component to desired position.
3. Tighten wing screw.

5.8.2 Adjusting Depth of Tray/Removing Tray

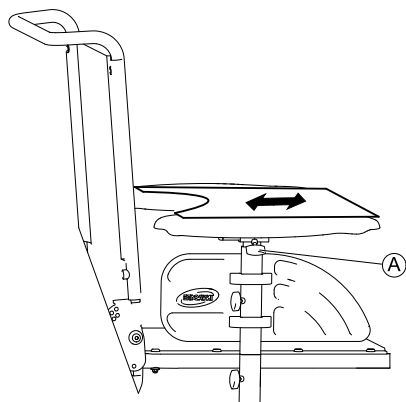

Fig. 5-8

1. Loosen wing screw (A).
2. Adjust component to desired position (or remove it entirely).
3. Tighten wing screw.

5.8.3 Swinging Tray Away to Side

The tray can be swivelled up and away to the side to allow the user to get in and out of the mobility device.



CAUTION!

Risk of injury! When the tray is raised it does not lock in place in this position!

- Do not tilt the tray up and leave it leaning in this position.
- Never attempt to drive with the tray tilted up.
- Always lower the tray in a controlled manner.

5.9 Standard 80° footrest (type Stream)

5.9.1 Swivel the legrest outward and/or remove

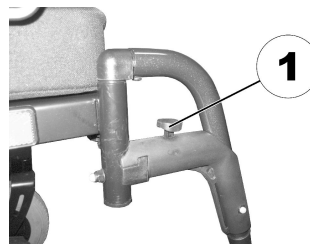

The small unlocking knob is in the legrest upper section (1). If the legrest is unlocked it can be swivelled to the inside or the outside to aid getting in, or removed completely.

1. Press the unlocking knob.
The legrest is unlocked.
2. Swivel the legrest inwards or outwards.
3. Simply pull up to remove legrest.

5.9.2 Adjusting the length



- 5 mm Allen key



1. Loosen the bolt (1) with the Allen key but do not remove it completely.
2. Adjust the legrest to the required length.
3. Retighten the screw.

5.10 Standard 80° Legrest

5.10.1 Swivelling and/or Removing Legrests (Standard 80° Legrest)

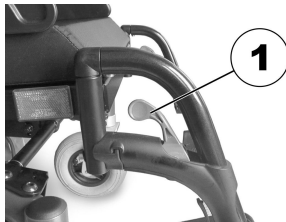

Fig. 5-9

The small release lever is to be found in the upper part of the legrest (1). When the legrest is released it can be

swivelled inward or outward to facilitate access and also be removed completely.



Fig. 5-10

1. Push release lever inward or outward.
2. Adjust component to desired position.
3. Pull upward to remove component .

5.10.2 Adjusting Length (Standard 80° Legrest)



- 5 mm Allen key



Fig. 5-11

1. Loosen screw (1).

 Do not remove screw (1).

2. Adjust component to desired position.
3. Tighten screw.

5.11 Manually Height-Adjustable Legrest

5.11.1 Swivelling and/or Removing Legrests (Manually Height Adjustable)

The unlocking knob is located on the top section of the legrests. When the legrest is unlocked, it can be swivelled to the inside or outside to facilitate getting in, or can be completely removed.

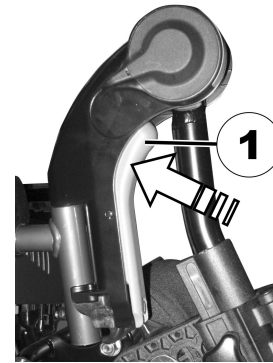

Fig. 5-12

1. Press unlocking knob (1) and remove legrests upwards.

5.11.2 Adjusting Legrest Angle (Manually Height Adjustable)



CAUTION!

Risk of crushing

- Do not reach inside the swivelling range of the legrest.



CAUTION!

Risk of injury due to incorrect adjustment of the footrests and legrests

- Before and during every journey it is imperative to ensure that the legrests contact neither the castor wheels nor the ground.

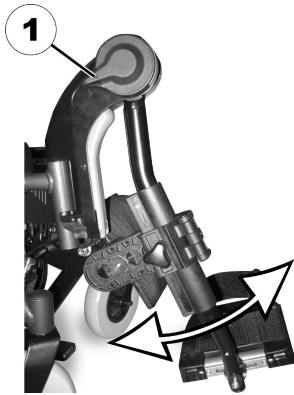

Fig. 5-13

1. Press unlocking lever (1) down.
2. Adjust component to desired position.
3. Release unlocking lever. Legrest engages.

5.11.3 Adjusting Legrest Length (Manually Height Adjustable)



CAUTION!

Risk of injury due to incorrect adjustment of the footrests and legrests

– Before and during every journey it is imperative to ensure that the legrests contact neither the castor wheels nor the ground.



- 5 mm Allen key

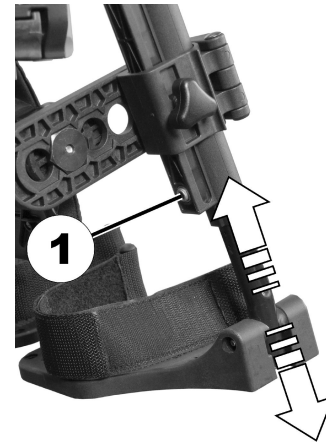

Fig. 5-14

1. Loosen screw (1).
2. Adjust component to desired position.
3. Tighten screw.

5.11.4 Adjusting Calf Pad Depth (Manually Height Adjustable)

The calf pad has four depth settings.



- 4 mm Allen key

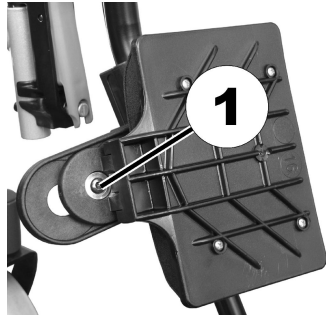

Fig. 5-15

1. Swivel calf pad to front.
2. Loosen and remove screw (1).
3. Set nut on other side to desired depth.
4. Adjust calf pad to match depth of nut, put screw back in and tighten.

5.11.5 Adjusting Calf Pad Height (Manually Height Adjustable)

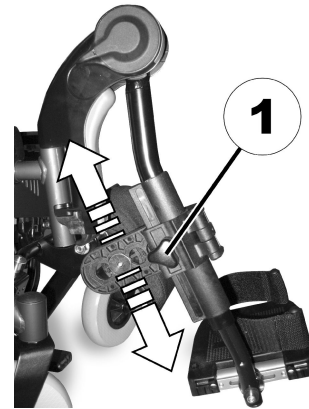

Fig. 5-16

1. Loosen hand screw (1).
2. Adjust component to desired position.
3. Tighten hand screw.

6 Usage

6.1 Driving



The maximum load capacity that is stated in the technical data only states that the system is designed for this mass in total. However, this does not mean that one can sit a person with this body weight in the mobility device without restrictions. Attention must be paid to the body proportions, such as height, weight distribution, abdominal belt, leg and calf strap and seat depth. These factors have a strong influence on driving features such as tilt stability and traction. The permissible axle loads in particular must be adhered to (refer to *11 Technical Data, page 63*). It may possibly be necessary to carry out adaptations to the seat system.

6.2 Before Driving for First Time

Before you take your first trip, you should familiarise yourself well with the operation of the mobility device and with all operating elements. Take your time to test all functions and driving modes.



If installed, make sure to properly adjust and use the posture belt each time you use the mobility device.

Sitting comfortably = Driving safely

Before each trip, make sure that:

- You are within easy reach of all operating controls.
- The battery charge is sufficient for the distance you intend to travel.

- The posture belt (if installed) is in perfect order.
- The rear mirror (if installed) is adjusted so you can look behind at all times without having to bend forward or shift your seating position.

6.3 Parking and Stationary

When parking your mobility device or if your mobility device is stationary for a prolonged period:

1. Switch the mobility device's power system off (ON-/OFF key).
2. Activate your anti-theft lock, if existing.

6.4 Getting in and out of Mobility Device



– The armrest must be removed or swiveled up in order to get into or out of the mobility device from the side.

6.4.1 Removing Standard Armrest for Side Transfer



This chapter relates to the standard armrest. For more information about other armrests, see the user manual of the seating system.

Depending on version, the armrest is fixed with one of several fastener options:

- Clamping lever
- Hand screw
- Locking pin
- Locking screw

The graphic below serves as an example.

Depending on which side the remote is installed on, you need to disconnect the remote cable before removing the armrest.

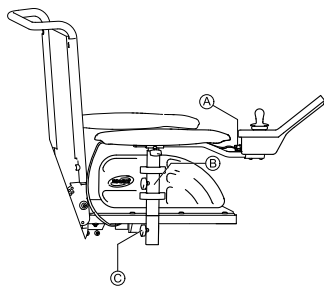

Fig. 6-1

1. Pull plug Ⓐ of remote cable to disconnect remote.
2. If necessary, remove remote cable from clip Ⓑ.
3. Loosen fastener Ⓒ.
4. Remove armrest from holder.

6.4.2 Information About Getting in and out



Fig. 6-2



WARNING!

Risk of serious injury or damage

Improper transfer techniques may cause serious injury or damage

- Before attempting transfers, consult a healthcare professional to determine proper transfer techniques for the user and type of wheelchair.
- Follow the instructions below.



If you do not have sufficient muscle strength, you should ask other persons for help. Use a sliding board, if possible.

Getting into Mobility Device:

1. Position your mobility device as close as possible to your seat. This might have to be done by an attendant.
2. Align casters parallel to drive wheels to improve stability during transfer.
3. Always switch your mobility device off.
4. Always engage both motor locks/clutches and free wheel hubs (if fitted) to prevent wheels from moving.
5. Depending on armrest type of your mobility device, detach armrest or swivel it up.
6. Now slide into mobility device.

Getting out of Mobility Device:

1. Position your mobility device as close as possible to your seat.
2. Align casters parallel to drive wheels to improve stability during transfer.
3. Always switch your mobility device off.

4. Always engage both motor locks/clutches and free wheel hubs (if fitted) to prevent wheels from moving.
5. Depending on armrest type of your mobility device, detach armrest or swivel it up.
6. Now slide onto your new seat.

6.5 Taking Obstacles

6.5.1 Maximum Obstacle Height

You can find information about maximum obstacle heights in the chapter entitled *11 Technical Data, page 63*.

6.5.2 Safety Information When Taking Obstacles



CAUTION!

Risk of tipping over

- Never approach obstacles at an angle but at 90 degrees as shown below.
- Approach obstacles followed by a gradient with caution. If unsure whether the gradient is too steep or not, move away from the obstacle and if possible try to find another location.
- Never approach obstacles on an uneven and/or loose ground.
- Never drive with too low tire pressure.
- Put your backrest into an upright position before ascending an obstacle.



CAUTION!

Risk of falling out of the mobility device and damage to the mobility device such as broken casters

- Never approach obstacles that are higher than the maximum climbable obstacle height.
- Never let the footrest/legrest touch the ground when descending an obstacle.
- If unsure whether taking an obstacle is possible or not, move away from the obstacle and if possible find another location.

6.5.3 Correct Way to Take Obstacles



The following instructions how to take obstacles also apply for attendants if the mobility device is fitted with an attendant control.

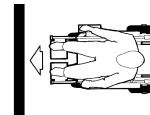

Fig. 6-3 Right



Fig. 6-4 Wrong

Ascending

1. Approach obstacle or curb slowly, head-on and at a right angle.
2. Depending on wheel drive type, stop in one of following positions:
 - a. In the case of centrally driven mobility devices: 5 - 10 cm before obstacle.
 - b. For all other drives: approx. 30 - 50 cm in front of obstacle.

3. Check position of front wheels. They must be in driving direction and at right angles to obstacle.
4. Approach slowly and keep at consistent speed until rear wheels have also passed over obstacle.

Ascending Obstacles With Curb Climber

1. Approach obstacle or curb slowly, head-on and at right angle.
2. Stop in following position: 30 – 50 cm in front of obstacle.
3. Check position of front wheels. They must be in driving direction and at right angles to obstacle.
4. Approach with full speed until curb climber makes contact with obstacle. Impetus will lift both front wheels over obstacle.
5. Keep at consistent speed until rear wheels have also passed over obstacle.

Descending

The approach to descend an obstacle is the same as to ascend it with the difference that you need not to stop before descending.

1. Descend obstacle with medium speed.



When descending an obstacle too slowly it could happen that the antitippers get stuck and lift the drive wheels off the ground. Driving the mobility device is then no longer possible.

6.6 Driving up and down gradients

For information concerning the rated slope, refer to *11 Technical Data, page 63*.



CAUTION!

Risk of tipping over

- Only ever drive downhill at a maximum of 2/3 of the top speed. Avoid sudden changes of direction or abrupt braking when driving on slopes.
- Always return the backrest of your seat or the seat tilt (if adjustable seat tilt is available) to an upright position before ascending slopes. We recommend that you position the seat backrest or the seat tilt slightly to the rear before descending slopes.
- Always lower the lifter (if fitted) to its lowest position before ascending or descending a slope.
- Never attempt to ascend or descend a slope on slippery surfaces or where there is a risk of skidding (such as wet pavement, ice etc).
- Avoid trying to get out of the vehicle on an incline or a gradient.
- Always drive straight in the direction the road or path you are on goes, rather than attempting to zigzag.
- Never attempt to turn around on an incline or a slope.



CAUTION!

Braking distance is much longer on a downhill slope than on even terrain

- Never drive down a slope that exceeds the rated slope (refer to *11 Technical Data, page 63*).



Important information about regulating the actuator functions on gradients

– Your mobility device is fitted with an angle sensor which guarantees tipping stability. The sensor measures the actual angle of the drive unit, and prevents any further decrease in stability by restricting the functionality of the adjustment actuators. If this safety function is activated, the backrest and the seat tilting can only be moved forwards, and the lifter can only be lowered. Reposition your mobility device on level ground so that the actuators can function normally again.

6.7 Use on Public Roads

If you wish to use your mobility device on public roads and lighting is required by national legislation, then your mobility device needs to be fitted with an appropriate lighting system.

Contact your Invacare provider if you have any questions.

6.8 Pushing the mobility device in freewheel mode

The motors of the mobility device are equipped with automatic brakes, preventing that the mobility device starts rolling out of control when the remote is switched off. When pushing the mobility device manually whilst freewheeling, the magnetic brakes must be disengaged.



Pushing the mobility device by hand may require more physical force than expected (more than 100 N). The necessary force nevertheless complies with the requirements of ISO 7176-14.



The intended use of the freewheel mode is to maneuver the mobility device over short distances. The push handles or push bars support this function, but be aware that there might be some impairment between the feet of the assistant and the rear part of the mobility device.

6.8.1 Disengaging Motors



CAUTION!

Risk of the mobility device running away

– When the motors are disengaged (for push operation whilst freewheeling), the electromagnetic motor brakes are deactivated. When the mobility device is parked, the levers for engaging and disengaging the motors must without fail be locked firmly into the "DRIVE" position (electromagnetic motor brakes activated).



The wheelchair disengaging mechanism is fitted with a gas pressure spring which prevents overloading the disengager. When the drive wheels are under torque load - for example if the wheelchair is on an incline - the gas pressure spring is activated. When the engaging lever is pressed forwards it does not remain in the "Pushed" position, but moves automatically back to the "Drive" position. To disengage the drive, the drive wheels must be unloaded by moving the wheelchair slightly forwards and backwards again.



The motors may only be disengaged by an attendant, not by the user.

This ensures that the motors are only disengaged if an attendant is available to secure the wheelchair and prevent unintended rolling.

The lever for disengaging the motors is on the rear right side on the wheelchair chassis.

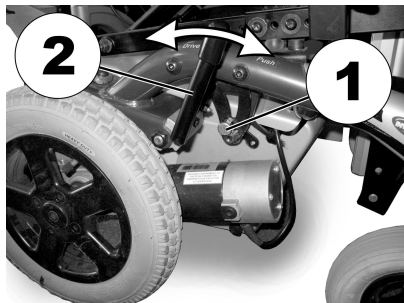

Disengaging motors:

1. Switch off remote.
2. Withdraw the locking pin (1). Push the engaging lever (2) forwards. If necessary, move the wheelchair slightly forwards and backwards during disengaging. The motors are disengaged.

Engaging motors:

1. Pull the engaging lever (2) to the rear. The motors are engaged.

7 Controls System

7.1 Controls Protection System

The wheelchair controls system is fitted with an overload protection.

If the drive is severely overloaded over a long period of time (for example, when driving up a steep hill) and especially when the ambient temperature is high, the controls system could overheat. In this case, the wheelchair performance is gradually reduced until it comes to a halt. The status display shows a corresponding error code (refer to the user manual for your remote). By switching the power supply off and back on again, the error code is cleared and the controls system is switched back on. It can however take up to five minutes until the controls system has cooled down enough for the drive to restore full performance again.

If the drive is stalled by an insurmountable obstacle, for example, a curb or similar which is too high, and the driver attempts driving for more than 20 seconds against this obstacle, the controls system automatically switches off to prevent the motors from being damaged. The status display shows a corresponding error code (refer to the user manual of your remote). By switching off and back on again, the error code is cleared and the controls system is switched back on.



A defective main fuse may be replaced only after checking the entire controls system. A specialised Invacare provider must perform the replacement. You can find information on the fuse type in *11 Technical Data, page 63*.

7.2 Batteries

Power is supplied by two 12 V batteries. The batteries are maintenance-free and only need regular charging.

In the following, you find information on how to charge, handle, transport, store, maintain, and use batteries.

7.2.1 General Information on Charging

New batteries should always be fully charged once before their first use. New batteries will be at their full capacity after having run through approx. 10 - 20 charging cycles (break-in period). This break-in period is necessary to fully activate the battery for maximum performance and longevity. Thus, range and running time of your mobility device could initially increase with use.

Gel/AGM lead acid batteries do not have a memory effect as NiCd batteries.

7.2.2 General Instructions on Charging

Follow the instructions listed below to ensure safe use and longevity of the batteries:

- Charge 18 hours prior to initial usage.
- We recommend charging the batteries daily after every discharge even after partly discharge, as well as each night over night. Depending on the level of discharge, it can take up to 12 hours until the batteries are fully charged again.
- When the battery indicator reached the red LED range, charge the batteries for 16 hours minimum, neglecting the charge complete display!
- Try to provide a 24 hour charge once a week to make sure that both batteries are fully charged.

- Do not cycle your batteries at a low state of charge without regularly recharging them fully.
- Do not charge your batteries under extreme temperatures. High temperatures above 30 °C are not recommended for charging as well as low temperatures below 10 °C.
- Use only charging devices in Class 2. This class of chargers may be left unattended during charging. All charging devices which are supplied by Invacare comply with these requirements.
- You cannot overcharge the batteries when using the charger supplied with your mobility device, or a charger that has been approved by Invacare.
- Protect your charger from sources of heat such as heaters and direct sunlight. If the battery charger overheats, charging current will be reduced and the charging process delayed.

7.2.3 Charging Batteries

Refer to the user manuals for your remote and battery charger for the position of the charging socket and further information about charging the batteries.



WARNING!

Risk of explosion and destruction of batteries if the wrong battery charger is used

- Only ever use the battery charger supplied with your mobility device, or a charger that has been approved by Invacare.



WARNING!

Risk of electric shock and damage to the battery charger if it gets wet

- Protect the battery charger from water.
- Always charge in a dry environment.



WARNING!

Risk of short circuit and electric shock if the battery charger has been damaged

- Do not use the battery charger if it has been dropped or damaged.



WARNING!

Risk of electric shock and damage to the batteries

- NEVER attempt to recharge the batteries by attaching cables directly to the battery terminals.



WARNING!

Risk of fire and electric shock if a damaged extension cable is used

- Only ever use an extension cable if it is absolutely necessary. In case you must use one, make sure it is in good condition.

**WARNING!****Risk of injury if using the mobility device during charging**

- DO NOT attempt to recharge the batteries and operate the mobility device at the same time.
- DO NOT sit in the mobility device while charging the batteries.

1. Switch off mobility device.
2. Connect battery charger to charger socket.
3. Connect battery charger to power supply.

7.2.4 Disconnecting Mobility Device After Charging

1. Once charging is complete, first disconnect battery charger from power supply, then disconnect plug from remote.

7.2.5 Storage and Maintenance

Follow the instructions listed below to ensure safe use and longevity of the batteries:

- Always store the batteries fully charged.
- Do not leave the batteries in a low state of charge for an extended length of time. Charge a discharged battery as soon as possible.
- In case your mobility device is not used for a longer period of time (that is more than two weeks), the batteries must be charged at least once a month to maintain a full charge and always be charged before use.
- Avoid hot and cold extremes when storing. We recommend to store batteries at a temperature of 15 °C.

- Gel and AGM batteries are maintenance-free. Any performance issues should be handled by a properly trained mobility device technician.

7.2.6 Instructions on Using Batteries**CAUTION!****Risk of damaging the batteries.**

- Avoid ultra-deep discharges and never drain your batteries completely.

- Pay attention to the Battery Charge Indicator! Charge the batteries when the Battery Charge Indicator shows that battery charge is low.
How fast the batteries discharge depends on many circumstances, such as ambient temperature, condition of the surface of the road, tire pressure, weight of the driver, way of driving and utilisation of lighting, if fitted.
- Try to charge the batteries always before you reach the red LED range.
The last 3 LED (two red and one orange) mean a remaining capacity of about 15 %.
- Driving with flashing red LED's means an extreme stress for the battery and should be avoided under normal circumstances.
- When only one red LED is flashing, the Battery Safe feature is enabled. From this time, speed and acceleration is reduced drastically. It will allow you to move the mobility device slowly out of a dangerous situation before the electronic finally cuts off. This is deep discharging and should be avoided.

- Be aware that for temperatures below 20 °C, the nominal battery capacity starts to decline. For example, at -10 °C the capacity is reduced to about 50 % of the nominal battery capacity.
- To avoid damaging the batteries, never allow them to be fully discharged. Do not drive on heavily discharged batteries if it is not absolutely necessary, as this will strain the batteries unduly and shorten their life expectancy.
- The earlier you recharge the batteries, the longer they live.
- The depth of discharge affects the cycle life. The harder a battery has to work, the shorter is its life expectancy. Examples:
 - One deep discharge stresses the same as 6 normal cycles (green /orange display off).
 - The battery life is about 300 cycles at 80 % discharge (first 7 LED off), or about 3000 cycles at 10 % discharge (one LED off).



The number of LED can vary depending on the remote type.

- Under normal operation, once a month the battery should be discharged until all green and orange LED are off. This should be done within one day. A 16 hour charge afterwards is necessary as reconditioning.

7.2.7 Transporting Batteries

The batteries supplied with your mobility device are not hazardous goods. This classification is based on the German GGVS Hazardous Goods Road Transport Ordinances, and the IATA/DGR Hazardous Goods Rail Transport / Air Transport Ordinances. Batteries may be transported without

restrictions, whether by road, rail or by air. Individual transport companies have, however, guidelines which can possibly restrict or forbid certain transport procedures. Please ask the transport company regarding each individual case.

7.2.8 General Instructions on Handling Batteries

- Never mix and match different battery manufactures or technologies, or use batteries that do not have similar date codes.
- Never mix gel with AGM batteries.
- The batteries reach their end of life when the drive range is significantly smaller than usual. Contact your provider or service technician for details.
- Always have your batteries installed by a properly trained mobility device technician or a person with adequate knowledge. They have the necessary training and tools to do the job safely and correctly.

7.2.9 Handling Damaged Batteries Correctly



CAUTION!

Corrosion and burns from acid leakage if batteries are damaged

- Remove clothes that have been soiled by acid immediately.

After contact with skin:

- Immediately wash affected area with lots of water.

After contact with eyes:

- Immediately rinse eyes under running water for several minutes; consult a physician.

- Always wear safety goggles and appropriate safety clothing when handling damaged batteries.
- Place damaged batteries in an acid-resistant receptacle immediately after removing them.
- Only ever transport damaged batteries in an appropriate acid-resistant receptacle.
- Wash all objects that have come into contact with acid with lots of water.

Disposing of Dead or Damaged Batteries Correctly

Dead or damaged batteries can be given back to your provider or directly to Invacare.

8 Transport

8.1 General Information on Transport



WARNING!

Risk of death or serious injury to the mobility device user and potentially any other nearby occupant of the vehicle, if a mobility device is secured using a 4-point tie-down system available from a third party supplier and the unladen weight of the mobility device exceeds the maximum weight for which the tie-down system is certified

- Make sure the weight of the mobility device does not exceed the weight for which the tie-down system is certified. Consult the tie-down manufacturer's documentation.
- If you are unsure how much your mobility device weighs, then you must have it weighed using calibrated scales.



CAUTION!

Risk of injury or material damage if a mobility device which is fitted with a tray is transported in a vehicle

- If a tray is fitted, always remove it before transporting the mobility device.



Fig. 8-1

8.2 Transferring Mobility Device to Vehicle



WARNING!

Mobility device is at risk of tipping over if transferred to a vehicle while user is still seated in mobility device

- Transfer mobility device without user whenever possible.
- If mobility device with user must be transferred to vehicle using a ramp, ensure that ramp does not exceed rated slope.
- If mobility device must be transferred to vehicle using a ramp that does exceed rated slope, a winch must then be used. An attendant can then safely monitor and assist transfer process.
- Alternatively, a platform lift may be used.
- Ensure that total weight of mobility device including user does not exceed maximum permitted total weight for ramp or platform lift.
- Mobility device should always be transferred to vehicle with backrest in upright position, seat lifter lowered and tilt in upright position (refer to *Driving up and down Gradients*).

**WARNING!****Risk of injury and damage to mobility device and vehicle**

Risk of tipping over or uncontrolled movements of mobility device if transferred to vehicle using a ramp that exceeds rated slope.

- Transfer mobility device to vehicle without user.
- An attendant must assist transfer process.
- Ensure that all carer fully understand manual of ramp and winch.
- Ensure that winch is suitable for your mobility device.
- Use only suitable tie-down points. Do not use removable or movable components of mobility device as tie-down points.

**WARNING!****Risk of injury and damage to mobility device**

If mobility device must be transferred to vehicle via a lift, when remote is turned on, there is a risk that device may act erratically and fall off lift.

- Before transferring mobility device via lift, turn off product and disconnect either bus cable from remote or batteries from system.

1. Drive or push your mobility device into transport vehicle using suitable ramp.

8.3 Using Mobility Device as Vehicle Seat



The following section does not apply to models or configurations which may not be used as a vehicle seat. These are identified by the following label on the mobility device:

**WARNING!****Risk of injury**

Safety restraint devices must only be used when the wheelchair user's weight is 22 kg or more.

- When the user weight is lower than 22 kg, do not use the wheelchair as a seat in a vehicle.



CAUTION!

Risk of injury if the mobility device is not properly secured during use as a vehicle seat.

- If possible, the user should always leave the mobility device to use a vehicle seat and the safety belts provided with the vehicle.
- The mobility device should always be anchored facing in the transport vehicle's intended direction of travel.
- The mobility device must always be secured in accordance with the mobility device and anchoring system manufacturers' user manual.
- Always remove and secure any accessory parts fixed to the mobility device such as chin controls or tables.
- If your mobility device is fitted with an angle adjustable backrest, then it must be placed in an upright position.
- Fully lower elevated legrests, if fitted.
- Fully lower the seat lifter, if fitted.



CAUTION!

Risk of injury if a mobility device that is not fitted with leak-proof batteries is transported in a vehicle.

- Only ever use leak-proof batteries.



CAUTION!

Risk of injury or damage to the mobility device or to the transporting vehicle, if the legrests are in a raised position while the mobility device is used as a vehicle seat.

- Always completely lower height-adjustable legrests, if fitted.



To use a mobility device as a motor vehicle seat, it needs to be fitted with tie-down points to enable anchoring in the motor vehicle. These accessories may be included in the standard scope of mobility device order and delivery in some countries (UK for example), but may also be obtained from Invacare as an option in other countries.

This mobility device complies with the requirements of ISO 7176-19 and may be used as a vehicle seat in connection with an anchoring system that has been checked and approved in accordance with ISO 10542. The transporting vehicle must be professionally converted to anchor the mobility device. Contact your vehicle's manufacturer for more information.

The mobility device has undergone a crash test in which it was anchored in the transporting vehicle's direction of travel. Other configurations were not tested. The crash test dummy was secured using pelvic and upper body safety belts. Both types of safety belt should be used in order to minimise the risk of injuries to head or upper body.



Invacare tests with a 4-point tie-down system from BraunAbility® Safety Systems.

- Contact BraunAbility for more information on how to obtain such a system for your country and vehicle type. For information concerning the kerb weight, see *11 Technical Data, page 63*.

It is imperative that the mobility device is inspected by an authorised provider before being used again after being involved in a crash. Alterations to the mobility device anchoring points may not be carried out without the manufacturer's permission.

8.3.1 How the mobility device is tied down in a vehicle

The mobility device is fitted with four tie-down points. Snap hooks or belt loops can be used for fixation. If the mobility device can be used as a vehicle seat, these tie-down points are labelled with the symbol shown on the right.

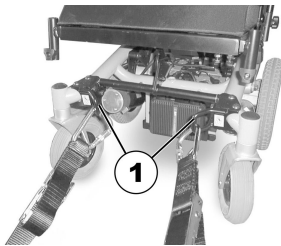

Fig. 8-2 Front

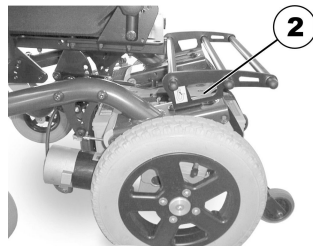

Fig. 8-3 Rear

1. Secure the mobility device at the front (1) and at the rear (2) with the tie-down system belts.
2. Secure the mobility device by tensioning the belts in accordance with the tie-down system manufacturer's user manual.

8.3.2 Securing User in Mobility Device



CAUTION!

Risk of injury if the user is not properly secured within the mobility device

- Even if the mobility device is fitted with a posture belt, this is no substitute for a proper safety belt which complies with ISO 10542 in the transport vehicle. Always use the safety belt installed in the transport vehicle.
- Safety belts must be in contact with the user's body. They must not be held at a distance from the user's body using parts of the mobility device such as armrests or wheels.
- Safety belts must be pulled as tightly as possible without causing the user discomfort.
- Safety belts must not be positioned while twisted.
- Ensure that the third seat belt anchorage point is not fixed directly to the vehicle floor, but to one of the vehicle uprights.



CAUTION!

Risk of injury during use of the mobility device as a vehicle seat if a headrest is wrongly adjusted or not installed

This can cause the neck to be hyperextended during collisions.

- A headrest must be installed. The headrest optionally supplied for this mobility device by Invacare is perfectly suitable for use during transport.
- The headrest must be adjusted to the user's ear height.

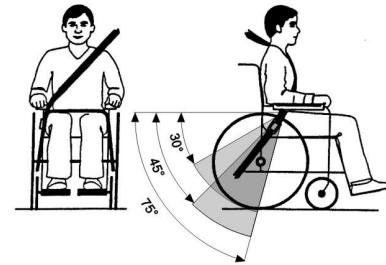

Fig. 8-6

The pelvic belt should be positioned in the area between the user's pelvis and thighs so that it is unobstructed and not too loose. The ideal angle of the pelvic belt to the horizontal is between 45° and 75°. The maximum permissible angle is between 30° and 75°. The angle should never be less than 30°!

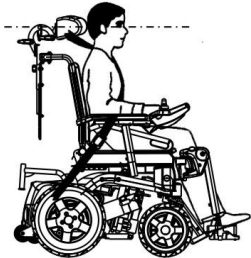

Fig. 8-4



Fig. 8-5

Seat belts may not be held at a distance from the user's body using parts of the mobility device such as armrests or wheels.

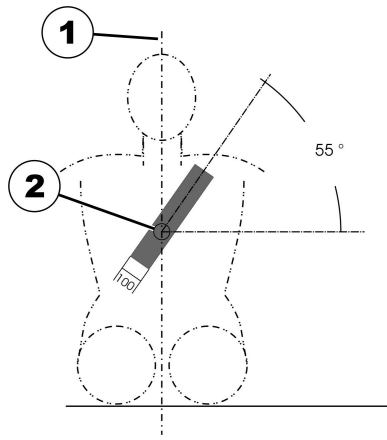

Fig. 8-7

The safety belt installed in the transporting vehicle should be applied as shown in the illustration above.

- 1) Center line of the body
- 2) Center of the sternum

8.4 Transporting Mobility Device Without Occupant



CAUTION! Risk of injury

- If you are unable to fasten your mobility device securely in a transport vehicle, Invacare recommends that you do not transport it.

Your mobility device may be transported without restrictions, whether by road, rail or by air. Individual transport

companies have, however, guidelines which can possibly restrict or forbid certain transport procedures. Please ask the transport company regarding each individual case.

- Before transporting your mobility device, make sure the motors are engaged and that the remote is switched off. Invacare strongly recommends that you additionally disconnect or remove the batteries. Refer to Removing the batteries.
- Invacare strongly recommends securing the mobility device to the floor of the transporting vehicle.

9 Maintenance

9.1 Maintenance Introduction

The term “Maintenance” means any task performed to ensure that a medical device is in good working order and ready for use as intended. Maintenance encompasses different areas, such as everyday care and cleaning, inspection checks, repair tasks and refurbishment.



Have your vehicle checked once a year by an authorised Invacare provider to maintain its driving safety and roadworthiness.

9.2 Inspection Checks

The following tables list inspection checks that should be performed by the user and their intervals. If the mobility device fails to pass one of the inspection checks, refer to the chapter indicated or contact your authorised Invacare provider. A more comprehensive list of inspection checks and instructions for maintenance work can be found in the service manual for this device, which can be obtained from Invacare. That manual, however, is intended to be used by trained and authorised service technicians, and describes tasks which are not intended to be performed by the user.

9.2.1 Before Each Use of Mobility Device

Item	Inspection Check	If Inspection is not Passed
Screwed connections	Check all connections, such as backrests and wheels, for tight fit.	Contact your provider.
Signal horn	Check for correct function.	Contact your provider.
Lighting system	Check that all lights, such as turn indicators, head lamps and tail lights, are functioning correctly.	Contact your provider.
Batteries	Make sure batteries are charged. Refer to user manual provided with your remote for a description of Battery Charge Indicator.	Charge the batteries (refer to <i>7.2.3 Charging Batteries, page 46</i>).

9.2.2 Weekly

Item	Inspection check	If inspection is not passed
Armrests /side parts	Check that armrests are firmly attached in their holders and do not wobble.	Tighten the screw or clamping lever that holds the armrest (see chapter 5 <i>Setup, page 26</i>). Contact your provider.
Tires (pneumatic)	Check that the tires are undamaged.	Contact your provider.
	Check that the tires are inflated to the correct pressure.	Inflate the tire to the correct pressure (see chapter 11 <i>Technical Data, page 63</i>). Contact your provider to have it repaired.
Tires (puncture-proof)	Check that the tires are undamaged.	Contact your provider.

9.2.3 Monthly

Item	Inspection Check	If Inspection is not Passed
All upholstered parts	Check for damage and wear.	Contact your provider.
Removable legrests	Check whether legrests can be fixed securely and whether loosening mechanism is properly operable.	Contact your provider.
	Check that all adjustment options function properly.	Contact your provider.
Castors	Check that castors rotate and swivel freely.	Contact your provider.
Drive wheels	Check that drive wheels rotate without wobbling. It is easiest to have someone stand behind mobility device and observe drive wheels as you drive away from them to do this.	Contact your provider.
Electronics and connectors	Check all cables for damage and all connecting plugs for snug fit.	Contact your provider.

9.3 Wheels and Tyres

Dealing With Wheel Damages

In case of having a damaged wheel, contact your provider. Because of safety reasons do not have the wheel repaired by yourself or by not authorised persons.

Dealing With Pneumatic Tyres



Risk of damage to tyre and rim

Never drive with too low tyre pressure, this could result in damage to tyre.

If tyre pressure is exceeded rim could be damaged.

– Inflate tyres to recommended pressure.



Use tyre gauge to check pressure.

Check weekly that the tyres are inflated to the correct pressure, see chapter *9.2 Inspection Checks, page 56*.

For recommended tyre pressure see inscription on tyre/rim or contact Invacare. Compare table below for conversion.

psi	bar
22	1.5
23	1.6
25	1.7
26	1.8
28	1.9

psi	bar
29	2.0
30	2.1
32	2.2
33	2.3
35	2.4
36	2.5
38	2.6
39	2.7
41	2.8
44	3.0

9.4 Short-Term Storage

In case a serious fault is detected, a number of safety mechanisms are built into your mobility device and will protect it. The power module prevents your mobility device from driving.

When the mobility device is in such a condition and while waiting for repair:

1. Switch off power.
2. Disconnect the batteries.
Depending on the mobility device model, you can either remove the battery packs or disconnect the batteries from the power module. Refer to the corresponding chapter about disconnecting the batteries.
3. Contact your provider.

9.5 Long-Term Storage

In case your mobility device is not used for a longer period of time, you need to prepare it for storage to ensure a longer life for your mobility device and batteries.

Storing Mobility Device and Batteries

- We recommend to store the mobility device at a temperature of 15 °C, avoid hot and cold extremes when storing to ensure a long service life of the product and batteries.
- The components are tested and approved for greater temperature ranges as detailed below:
 - Allowable temperature range to store the mobility device is -40° up to 65 °C.
 - Allowable temperature range to store batteries is -25° up to 65 °C.
- Even not being used, batteries discharge themselves. Best practice is to disconnect the battery supply from the power module if storing the mobility device longer than two weeks. Depending on the mobility device model, you can either remove the battery packs or disconnect the batteries from the power module. Refer to the corresponding chapter about disconnecting the batteries. If in doubt which cable to disconnect, contact your provider.
- Batteries should always be fully charged before storing.
- If storing the mobility device longer than four weeks, check the batteries once a month and recharge as needed (before gauge reads half full) to avoid damage.
- Store in a dry, well-ventilated environment protected from outer influences.
- Slightly overinflate pneumatic tyres.

- Position the mobility device on flooring that is not discoloured by contact with tyre rubber.

Preparing Mobility Device for Use

- Re-connect the battery supply to the power module.
- The batteries must be charged before use.
- Have the mobility device checked by an authorised Invacare provider.

9.6 Cleaning and Disinfection

9.6.1 General safety information



CAUTION!

Risk of contamination

- Take precautions for yourself and use appropriate protective equipment.



CAUTION!

Risk of electric shock and product damage

- Switch off the device and disconnect from mains, if applicable.
- When cleaning electronic components consider their protection class regarding water ingress.
- Make sure that no water splashes to the plug or the wall outlet.
- Do not touch the power socket with wet hands.

! **IMPORTANT!**

- Wrong fluids or methods can harm or damage the product.
- All cleaning agents and disinfectants used must be effective, compatible with one another and must protect the materials they are used to clean.
 - Never use corrosive fluids (alkalines, acid etc.) or abrasive cleaning agents. We recommend an ordinary household cleaning agent such as dishwashing liquid, if not specified otherwise in the cleaning instructions.
 - Never use a solvent (cellulose thinner, acetone etc.) that changes the structure of the plastic or dissolves the attached labels.
 - Always make sure that the product is completely dried before taking into use again.



For cleaning and disinfection in clinical or long-term care environments, follow your in-house procedures.

9.6.2 Cleaning Intervals

! **IMPORTANT!**

- Regular cleaning and disinfection enhances smooth operation, increases the service life and prevents contamination.
- Clean and disinfect the product
- regularly while it is in use,
 - before and after any service procedure,
 - when it has been in contact with any body fluids,
 - before using it for a new user.

9.6.3 Cleaning

! **IMPORTANT!**

- The product does not tolerate cleaning in automatic washing plants, with high-pressure cleaning equipment or steam.

! **IMPORTANT!**

- Dirt, sand and seawater can damage the bearings and steel parts can rust if the surface is damaged.
- Only expose the wheelchair to sand and seawater for short periods and clean it after every trip to the beach.
 - If the wheelchair is dirty, wipe off the dirt as soon as possible with a damp cloth and dry it carefully.

1. Remove any installed optional equipment (only optional equipment which does not require tools).
2. Wipe down the individual parts using a cloth or soft brush, ordinary household cleaning agents (pH = 6 - 8) and warm water.
3. Rinse the parts with warm water.
4. Thoroughly dry the parts with a dry cloth.



Car polish and soft wax can be used on painted metal surfaces to remove abrasions and restore gloss.

Cleaning upholstery

For cleaning upholstery refer to the instructions on the labels of the seat, cushion and backrest cover.

9.6.4 Disinfection



Information on recommended disinfectants and methods can be found on <https://vah-online.de/en/for-users>.

1. Wipe down all generally accessible surfaces with a soft cloth and ordinary household disinfectant.
2. Allow the product to air-dry.

10 After Use

10.1 Reconditioning

This product is suitable for reuse. To recondition the product for a new user, carry out the following actions:

- Inspection according to service plan. See service manual, available from Invacare.
- Cleaning and disinfection. Refer to *9 Maintenance, page 56*.
- Adaptation to the new user. Refer to *5 Setup, page 26*.

Make sure that the user manual is handed over with the product.

If any damage or malfunction is detected, do not reuse the product.

10.2 Disposal



WARNING!

Environmental Hazard

Device contains batteries.

This product may contain substances that could be harmful to the environment if disposed of in places (landfills) that are not appropriate according to legislation.

- DO NOT dispose of batteries in normal household waste.
- Batteries MUST be taken to a proper disposal site. The return is required by law and free of charge.
- Do only dispose discharged batteries.
- Cover terminals of lithium batteries prior to disposal.
- For information on the battery type see battery label or chapter *11 Technical Data, page 63*.

Be environmentally responsible and recycle this product through your recycling facility at its end of life.

Disassemble the product and its components, so the different materials can be separated and recycled individually.

The disposal and recycling of used products and packaging must comply with the laws and regulations for waste handling in each country. Contact your local waste management company for information.

11 Technical Data

11.1 Technical specifications

The technical information provided hereafter applies to a standard configuration or represents maximum achievable values. These can change if accessories are added. The precise changes to these values are detailed in the sections for the respective accessories.

 Note that in some cases the measured values may vary up to ± 10 mm.

Permissible operating and storage conditions	
Temperature range for operation according to ISO 7176-9:	<ul style="list-style-type: none"> -25° ... +50 °C
Recommended storage temperature:	<ul style="list-style-type: none"> 15 °C
Temperature range for storage according to ISO 7176-9:	<ul style="list-style-type: none"> -25° ... +65 °C with batteries -40° ... +65 °C without batteries

Electrical system	
Motors	<ul style="list-style-type: none"> 2 x 180 W (6 km/h) 2 x 220 W (9 km/h)
Batteries	<ul style="list-style-type: none"> 2 x 12 V / 50 Ah (C20) leakproof/AGM 2 x 12 V / 60 Ah (C20) leakproof/gel
Main fuse	<ul style="list-style-type: none"> 60 A
Degree of protection	IPX4 ¹

Charging device	
Output current	<ul style="list-style-type: none"> 8 A \pm 8 %
Output voltage	<ul style="list-style-type: none"> 24 V nominal (12 cells)

Drive wheel tires	
Tire type	<ul style="list-style-type: none"> • 3.00 - 8" pneumatic or puncture-proof
Tire pressure	<p>The recommended maximum tire pressure in bar or kpa is marked on the side wall of the tire or the rim. If more than one value is listed, the lower one in the corresponding units applies.</p> <p>(Tolerance = -0.3 bar, 1 bar = 100 kpa)</p>

Caster tires	
Tire type	<ul style="list-style-type: none"> • 2.80/2.50-4 puncture-proof

Driving characteristics	
Speed	<ul style="list-style-type: none"> • 6 km/h • 9 km/h
Min. braking distance	<ul style="list-style-type: none"> • 1000 mm (6 km/h) • 1800 mm (9 km/h)
Rated slope ²	<ul style="list-style-type: none"> • 6° (10.5 %) according to manufacturer's specifications with 130 kg payload, 4° seat angle, 20° backrest angle
Max. climbable obstacle height	<ul style="list-style-type: none"> • 50 mm
Turning diameter	<ul style="list-style-type: none"> • 1660 mm
Pivot width	<ul style="list-style-type: none"> • 1450 mm
Drive range in accordance with ISO 7176-4:2008 ³	<ul style="list-style-type: none"> • 26 km (with 2 x 12 V / 60 Ah (C20) leakproof/gel)

Dimensions according to ISO 7176-15	
Total height	<ul style="list-style-type: none"> • 1000 mm
Max. total width	<ul style="list-style-type: none"> • 640 mm
Total length (incl. standard legrests)	<ul style="list-style-type: none"> • 1060 mm
Stowage length	<ul style="list-style-type: none"> • 815 mm
Stowage width	<ul style="list-style-type: none"> • 630 mm
Stowage height	<ul style="list-style-type: none"> • 966 mm
Ground clearance	<ul style="list-style-type: none"> • 80 mm
Seat height (with manual seat angle adjuster) ⁴	<ul style="list-style-type: none"> • 490 – 592 mm
Seat width (armrest adjustment range in brackets)	<ul style="list-style-type: none"> • 495 – 545 mm (450 – 505 mm⁵)
Seat depth	<ul style="list-style-type: none"> • 410 / 460 / 520 mm
Backrest height ⁴	<ul style="list-style-type: none"> • 540 mm
Seat cushion thickness	<ul style="list-style-type: none"> • 50 mm
Backrest angle (manual)	<ul style="list-style-type: none"> • 92.45°, 103.3°, 111.6°, 117.2°, 125.3°, 128.8°
Armrest height	<ul style="list-style-type: none"> • 255 – 330 mm
Armrest length	<ul style="list-style-type: none"> • 340 mm
Horizontal location of axle ⁶	<ul style="list-style-type: none"> • 111 mm
Legrest length	<ul style="list-style-type: none"> • 395 – 430 mm
Seat angle (manual)	<ul style="list-style-type: none"> • -8.2° ... +32°

Weight⁷	
Curb weight	<ul style="list-style-type: none"> • 105 kg

Component weights	
Batteries 50 Ah	<ul style="list-style-type: none"> • approx. 15 kg per battery
Batteries 60 Ah	<ul style="list-style-type: none"> • approx. 17.4 kg per battery

Payload	
Max. payload	<ul style="list-style-type: none"> • 130 kg

Axle loads	
Max. front axle load	<ul style="list-style-type: none"> • 142 kg
Max. rear axle load	<ul style="list-style-type: none"> • 153 kg

- 1 IPX4 classification means that the electrical system is protected against spray water.
- 2 Static stability according to ISO 7176-1 = 9° (15.8 %)
Dynamic stability according to ISO 7176-2 = 6° (10.5 %)
- 3 Note: The drive range of a mobility device is strongly influenced by external factors, such as the speed setting of the wheelchair, the charging state of the batteries, surrounding temperature, local topography, road surface characteristics, tire pressure, weight of user, drive style and use of batteries for lighting, servos etc.

The specified values are theoretical maximum achievable values measured according to ISO 7176-4:2008.
- 4 Measured without seat cushion
- 5 Width adjustable for side panel adjustment
- 6 Horizontal distance of wheel axle from intersection of loaded seat and backrest reference planes
- 7 The actual curb weight depends on the fittings your mobility device has been supplied with. Every Invacare mobility device is weighed when leaving the works. Refer to the nameplate for the curb weight (including batteries) measured.

12 Service

12.1 Inspections Performed

It is confirmed by stamp and signature that all jobs listed in the inspection schedule of the service and repair instructions have been properly performed. The list of the inspection jobs to be performed can be found in the service manual which is available through Invacare.

Delivery Inspection	1st Annual Inspection
Stamp of authorised provider / Date / Signature	Stamp of authorised provider / Date / Signature
2nd Annual Inspection	3rd Annual Inspection

Stamp of authorised provider / Date / Signature	Stamp of authorised provider / Date / Signature
4th Annual Inspection	5th Annual Inspection
Stamp of authorised provider / Date / Signature	Stamp of authorised provider / Date / Signature

Invacare Distributors

Australia:

Invacare Australia Pty. Ltd.
1 Lenton Place, North Rocks NSW
2151
Australia
Phone: 1800 460 460
Fax: 1800 814 367
orders@invacare.com.au
www.invacare.com.au

United Kingdom:

Invacare Limited
Pencoed Technology Park, Pencoed
Bridgend CF35 5AQ
Tel: (44) (0) 1656 776 222
Fax: (44) (0) 1656 776 220
uk@invacare.com
www.invacare.co.uk

Canada:

Invacare Canada L.P.
570 Matheson Blvd East, Unit 8
CDN Mississauga, On. L4Z 4G4
Phone: (905) 890 8300
Toll Free: 800.668.5324
www.invacare.ca

Eastern Europe, Middle East & CIS:

Invacare EU Export
Am Achener Hof 8
D-88316 Isny
Tel: (49) (0)7562 700 397
eu-export@invacare.com
www.invacare-eu-export.com

Ireland:

Invacare Ireland Ltd,
Unit 5 Seatown Business Campus
Seatown Road, Swords, County Dublin
Tel : (353) 1 810 7084
Fax: (353) 1 810 7085
ireland@invacare.com
www.invacare.ie

New Zealand:

Invacare New Zealand Ltd
4 Westfield Place, Mt Wellington 1060
New Zealand
Phone: 0800 468 222
Fax: 0800 807 788
sales@invacare.co.nz
www.invacare.co.nz



Invacare GmbH
Am Achener Hof 8
D-88316 Isny
Germany

1534065-O 2020-11-10



Making Life's Experiences Possible®



Yes, you can.®