

Dolomite Step Up®

1521677, 1521678, 1521679, 1536121, 1536122, 1579540,
1585401, 1587608, 1587609

en Walking table
User Manual

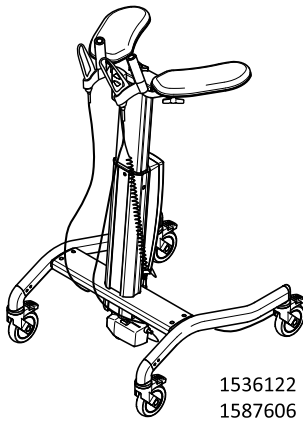
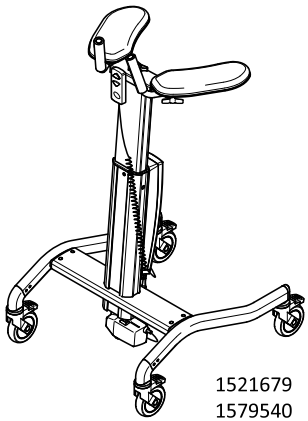
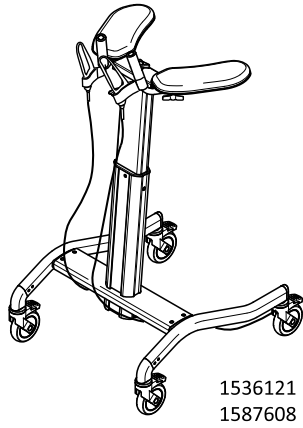
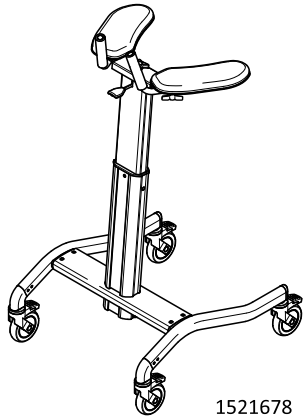
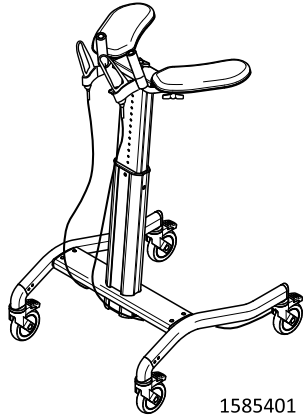
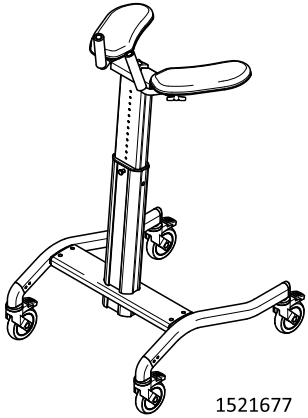

This manual MUST be given to the user of the product.
BEFORE using this product, this manual MUST be read and saved
for future reference.

Dolomite



Yes, you can.

©2020 Invacare Corporation

All rights reserved. Republication, duplication or modification in whole or in part is prohibited without prior written permission from Invacare. Trademarks are identified by ™ and ®. All trademarks are owned by or licensed to Invacare Corporation or its subsidiaries unless otherwise noted.

Making Life's Experiences Possible is a registered trademark in the U.S.A.

Contents

1 General	4
1.1 Introduction	4
1.2 Symbols in this Document	4
1.3 Compliance	4
1.3.1 Product-Specific Standards	4
1.4 Service Life	4
1.5 Warranty Information	4
1.6 Limitation of Liability	4
2 Safety	5
2.1 General Warnings	5
2.2 Safety Information about Step Up Electric	5
3 Product Overview	6
3.1 Intended Use	6
3.2 Product Description	6
3.3 Scope of Delivery	6
3.4 Labels and Symbols on Product	6
4 Usage	7
4.1 Before Use	7
4.2 Brakes	7
4.3 Rear Brakes with Integrated Directional Lock	7
4.4 Control unit - Step Up Electric	7
4.5 Emergency stop / lowering - Step Up Electric	8
4.6 Width adjustment - armrests / handles	8
4.7 Width adjustment - frame	9
4.8 Height adjustment	9
4.8.1 Height adjustment - Step Up Manual	9
4.8.2 Height adjustment - Step Up Hydraulic	10
4.8.3 Height adjustment - Step Up Electric	10
4.9 Rising to a standing position	10
5 Accessories	11
5.1 Accessories General	11
5.2 Hand Brakes	11
5.2.1 Adjusting the brakes	11
5.3 Hand Brakes for Models with Directional Lock	12
5.3.1 Adjusting the brakes	12
5.4 Basket	13
5.5 Tray	13
5.6 Alternative Hand Grips	13
5.7 Oxygen tank holder	13
5.8 IV pole	13
5.9 Elbow stop	13
5.10 Wheel with Directional Lock	13
5.11 Wheel 100 mm	14
5.12 Stand Assist	14
6 Maintenance	15
6.1 General Maintenance Information	15
6.2 Inspection Checklist	15
6.3 Cleaning and Disinfection	15
6.3.1 General Safety Information	15
6.3.2 Cleaning Intervals	15
6.3.3 Cleaning Instructions	15
7 After Use	16
7.1 Reconditioning	16
7.2 Disposal	16
8 Technical Data	17
8.1 Dimensions and Weights	17
8.2 Electrical data - Step Up Electric	17
8.3 Material	18
8.4 Environmental conditions	18
8.5 Electromagnetic compliance (EMC)	18
8.6 Electromagnetic compliance (EMC) - Guidance and manufacturer's declaration	19

1 General

1.1 Introduction

This user manual contains important information about the handling of the product. To ensure safety when using the product, read the user manual carefully and follow the safety instructions.

Note that there may be sections in this document, which are not relevant to your product, since this document applies to all available models (on the date of printing). If not otherwise stated, each section in this document refers to all models of the product.

The models and configurations available in your country can be found in the country-specific sales documents.

Invacare reserves the right to alter product specifications without further notice.

Before reading this document, make sure you have the latest version. You find the latest version as a PDF on the Invacare website.

If you find that the font size in the printed document is difficult to read, you can download the PDF version from the website. The PDF can then be scaled on screen to a font size that is more comfortable for you.

For more information about the product, for example product safety notices and product recalls, contact your Invacare distributor. See addresses at the end of this document.

In case of a serious incident with the product, you should inform the manufacturer and the competent authority in your country.

1.2 Symbols in this Document

Symbols and signal words are used in this document and apply to hazards or unsafe practices which could result in personal injury or property damage. See the information below for definitions of the signal words.



WARNING

Indicates a hazardous situation that could result in serious injury or death if it is not avoided.



CAUTION

Indicates a hazardous situation that could result in minor or slight injury if it is not avoided.



IMPORTANT

Indicates a hazardous situation that could result in damage to property if it is not avoided.



Tips and Recommendations

Gives useful tips, recommendations and information for efficient, trouble-free use.

1.3 Compliance

Quality is fundamental to the company's operation, working within the disciplines of ISO 13485.

This product features the CE mark, in compliance with the Medical Device Regulation 2017/745 Class I. The launch date of this product is stated in the CE declaration of conformity.

We are continuously working towards ensuring that the company's impact on the environment, locally and globally, is reduced to a minimum.

We only use REACH compliant materials and components.

We comply with the current environmental legislations WEEE and RoHS.

1.3.1 Product-Specific Standards

The product has been tested and conforms EN ISO 11199-3 (walking tables) and all related standards.

For further information about local standards and regulations, contact your local Invacare distributor. See addresses at the end of this document.

1.4 Service Life

The expected service life of this product is five years when used daily and in accordance with the safety instructions, maintenance intervals and correct use, stated in this manual. The effective service life can vary according to frequency and intensity of use.

1.5 Warranty Information

We provide a manufacturer's warranty for the product in accordance with our General Terms and Conditions of Business in the respective countries.

Warranty claims can only be made through the provider from whom the product was obtained.

1.6 Limitation of Liability

Invacare accepts no liability for damage arising from:

- Non-compliance with the user manual
- Incorrect use
- Natural wear and tear
- Incorrect assembly or set-up by the purchaser or a third party
- Technical modifications
- Unauthorised modifications and/or use of unsuitable spare parts

2 Safety

2.1 General Warnings



WARNING!

Risk of Serious Injury or Damage

Improper use of this product may cause injury or damage.

- If you are unable to understand the warnings, cautions or instructions, contact a health care professional or provider before attempting to use this equipment.
- Do not use this product or any available optional equipment without first completely reading and understanding these instructions and any additional instructional material such as user manual, service manual or instruction sheet supplied with this product or optional equipment.



WARNING!

Risk of falling

- The walking table is to be used solely as a platform support.
- Do not stand on the frame or on the armrests.
- Unevenly distributed weight affects the product's stability.
- Take special care on uneven surfaces.
- Take special care on wet surfaces.
- Take special care when operating the walking table in the presence of children and pets.
- Take care when moving over obstacles, e.g. doorways, when using the walking table with the accessory standing plate.
- The wheels must be locked when the user moves onto / off the standing plate.

2.2 Safety Information about Step Up Electric



WARNING!

Risk of injury (due to unintentional movements in product)

Electronic equipment can be influenced by Radio Frequency Interference (RFI)

- Caution should be exercised if portable communication equipment is used nearby this product.
- Should RFI cause erratic behaviour, the walking aid must immediately be turned off and not turned on until the cause has been detected and resolved.
- To turn off the walking aid; see *Emergency stop* in *4 Usage, page 7*; *Control unit - Step Up Electric*.



WARNING!

Step Up Electric; Restrictions for usage in wet areas due to the electrical components

- It may be run on the battery but it may not be connected to the mains, while in wet areas. See Technical data IPx4.
- Make sure the walking table is dry before connecting it to the mains.

3 Product Overview

3.1 Intended Use

The walking aid is intended to support a person's ability to stand and walk through gait training.

The walking aid is for indoor use only. It may be used in wet areas, but not under pouring water (e.g. shower). Step Up Electric must only be used in wet areas, when it's not connected to the mains.

The weight of the user must not exceed the maximum user weight as stated in chapter 8.1 *Dimensions and Weights*, page 17 and on the product label.

Contraindications

There are no contraindications known.

3.2 Product Description

Step Up is a height adjustable walking table available in different versions.

Step Up Manual

Walking table, height adjustment operated manually, with:

- Foot operated brake on all four wheels (model 1521677),
- Foot operated brake on the front wheels and hand operated / foot operated brake and directional lock on the rear wheels (model 1585401).

Step up Hydraulic

Walking table, height adjustment operated by a gas spring, with:

- Foot operated brake on all four wheels (model 1521678),
- Foot operated brake on the front wheels and hand operated brake on the rear wheels (model 1536121),
- Foot operated brake on the front wheels and hand operated / foot operated brake and directional lock on the rear wheels (model 1587608).

Step Up Electric

Walking table, height adjustment operated by an attenuator, with:

- Foot operated brake on all four wheels (models 1521679 and 1579540),
- Foot operated brake on the front wheels and hand operated brake on the rear wheels (model 1536122),
- Foot operated brake on the front wheels and hand operated / foot operated brake and directional lock on the rear wheels (model 1587609).

Models 1521679 and 1536122 have an external charger. Models 1579540 and 1587609 have an internal charger.

3.3 Scope of Delivery

- Walking table, fully assembled
- Control box and hand control (all Step Up Electric models)
- External charger (only Step Up Electric models 1521679 and 1536122)

- User manual

3.4 Labels and Symbols on Product

Identification Label

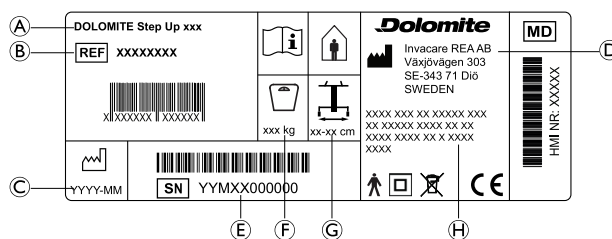

The label contains all important technical information regarding your product.

- | | | | |
|---|----------------------|---|---------------------|
| Ⓐ | Product name | Ⓕ | Maximum user weight |
| Ⓑ | Reference number | Ⓖ | Maximum width |
| Ⓒ | Date of manufacture | Ⓗ | Electrical data* |
| Ⓓ | Manufacturer address | | |
| Ⓔ | Serial number | | |

* Only on label of Step Up Electric models

Other Symbols on Label

	European Conformity		Read user manual
	Medical Device		Maximum width
	Reference number		Maximum user weight
	Serial number		Type B Applied Part*
	Date of manufacture		CLASS II equipment*
	Manufacturer		WEEE conform*
	Indoor use		

* Only on label of Step Up Electric models

Other Symbols on Product

	Refer to the user manual.
--	---------------------------

For further electrical information for the Step Up Electric, check label on the motor.

4 Usage

4.1 Before Use

We do not recommend that the product is issued to anyone without first carrying out a full assessment of their specific needs. To ensure user safety and contribute to the best rehabilitation, it is important that the user is given the necessary support by the product as prescribed by a qualified professional.

-  Before use; make sure that all the knobs and screws are properly tightened on:
- width adjustment frame
 - armrests
 - handles

4.2 Brakes

1.

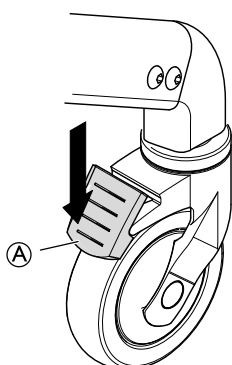

To lock brake, press down outer edge of brake pedal (A).

-  Press outer edge until a click is heard, this indicates that the wheel is locked.

2.

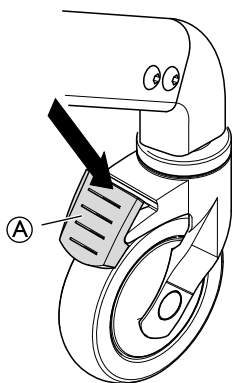

To unlock brake, press inner edge of brake pedal (A).

4.3 Rear Brakes with Integrated Directional Lock

only models 1585401, 1587608, 1587609

Directional Lock

-  A directional lock is used to lock the wheel in a straight position in order to ease movement straight ahead.

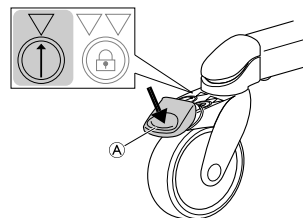

1. Press down brake pedal (A) one step in order to activate directional lock.
2. To unlock directional lock, press inner edge of brake pedal.

Brake Function

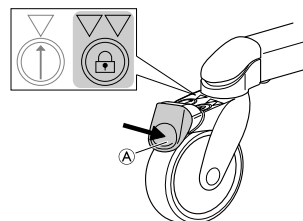

1. Press down brake pedal (A) two steps in order to lock brake.
2. To unlock brake, press inner edge of brake pedal.

4.4 Control unit - Step Up Electric



IMPORTANT!

- Allow the battery to charge for 24 hours before using the height adjustment for the first time.
- Height adjustment is not possible while charging the battery.
- Ensure that the emergency stop is not pushed in when the battery is to be charged.
- The product is connected to the mains with a mains plug. Make sure that the mains plug is accessible and can be unplugged if required.

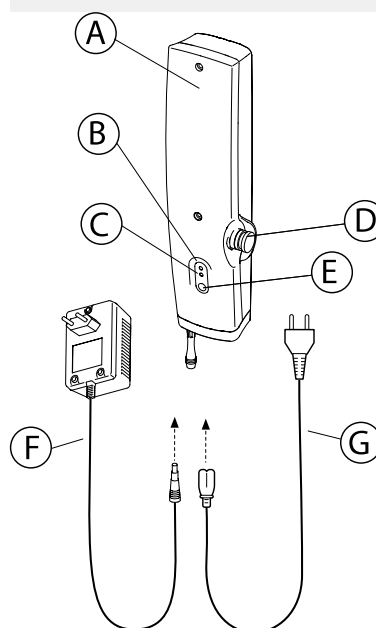

- (A) Control Unit
- (B) Yellow light — ON — Battery charging
- (B) Yellow light — OFF — Battery fully charged
- (C) Green light — ON — Motor is in use

- Ⓓ Emergency button (see separate section; 4.5 Emergency stop / lowering - Step Up Electric, page 8
- Ⓔ Emergency lowering (see separate section; 4.5 Emergency stop / lowering - Step Up Electric, page 8
- Ⓕ External battery charger
- Ⓖ Integrated battery charger
- Warning signal Beeps — Low battery capacity, battery needs charging

Charging the battery

Connect the control unit to the mains power socket to charge.

The product is delivered with a charger; external or integrated.

- i** • Charging stops automatically when the battery is fully charged.
- For maximum life, the battery should be charged regularly, e.g. every night.

4.5 Emergency stop / lowering - Step Up Electric

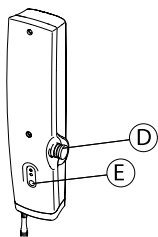

The walking table is equipped with emergency stop and emergency lowering.

- | | |
|---------------------------|-----------------------------|
| Emergency stop | Press red button Ⓓ |
| Emergency lowering | Press button Ⓔ |
| Reset | Turn red button Ⓓ clockwise |

4.6 Width adjustment - armrests / handles

Adjustment armrests

Side stops for the elbows are available as accessories.

Regardless of body size, an angle of 25° between shoulder and wrist position gives the best conditions to enable the torso to remain upright

- i** The position is pre-set and is maintained regardless of width setting.

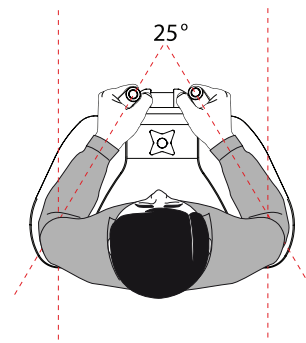

- Set the armrests so that the elbows are located close to the body. This automatically produces a stable three point position where the hands are moved as close to each other as possible in relation to the user's body size.
- The armrests have a pressure-relieving material in the cushions and they are made in order to withstand disinfection. They are securely attached with microfilm.
- For replacement or cleaning remove them by hand. When refitting ensure they are correctly positioned.

1.

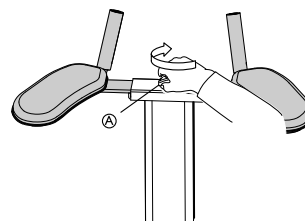

Loosen the knob Ⓐ which is located between the armrests.

2.

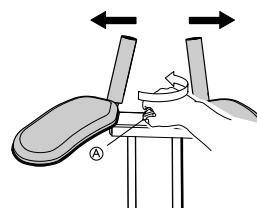

Adjust sideways to the required width.

3. Lock the armrests again by tightening the knob Ⓐ.

Adjustment handles

Alternative hand grips are available as accessories.

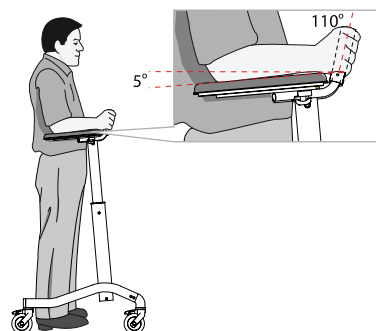

- The forearm support is inclined 5° in the horizontal plane in order to produce a natural and erect position
- The handles are inclined forward 110° from the forearm support. This produces an ergonomic positioning of the wrists and the best conditions for a firm grip.

1.

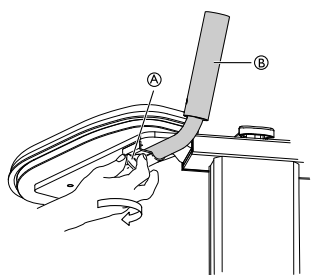

Loosen the knob (A) which is located under the armrests.

2.

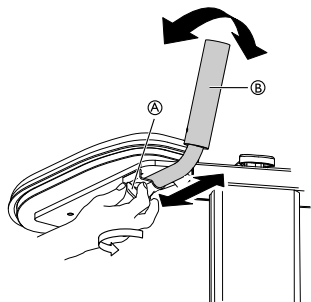

Adjust the handles (B) to the required depth and angle.

3. Re-tighten the knob (A) to lock the handles in the new position.

4.7 Width adjustment - frame



WARNING!

Risk of pinching

– Be aware of the risk of getting fingers pinched when adjusting the frame



CAUTION!

Risk of instability

– The frame must be symmetrical and have the same width on both sides.

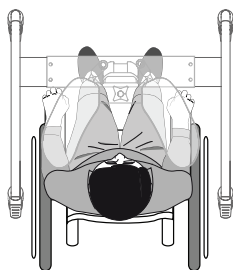
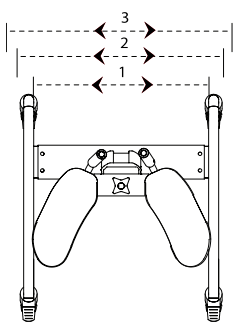

- The walking table can be adjusted in three widths.
- The H-shaped lower frame has the same dimensions in the front and back.



Adjust the width so that the walking table can pass through the most narrow passage in the premises.

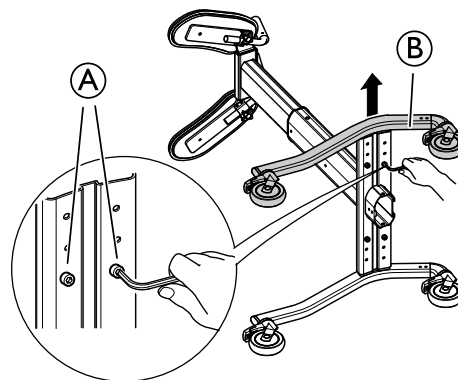

1. Lay the walking table down.
2. Remove screws (A).
3. Adjust the frame (B) to the required width on one side.
4. Reinsert the screws and tighten with a minimum of 10 Nm.
5. Repeat the procedure on the other side.



6 mm allen key

4.8 Height adjustment

To get the correct height of the walking table we recommend measuring the distance from elbow to heel while the user is lying down.

4.8.1 Height adjustment - Step Up Manual

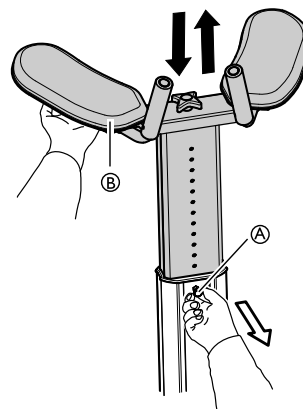

Lift the armrests (B) slightly upwards in order to pull the pin (A) out and adjust the support platform to the required height.



Check that the pin (A) is pressed in correctly, in order to lock the height adjustment.



WARNING!

Risk of falling

– Do not pull out the pin if the user is putting weight on the support platform.

4.8.2 Height adjustment - Step Up Hydraulic

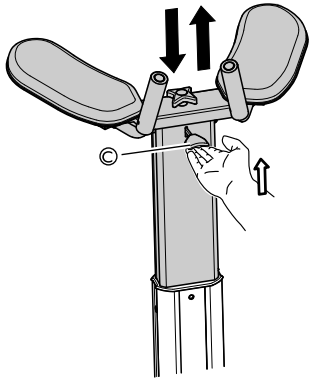

Lift the lever and adjust the support platform to the required height by pulling upwards or pushing gently on the armrests.

4.8.3 Height adjustment - Step Up Electric

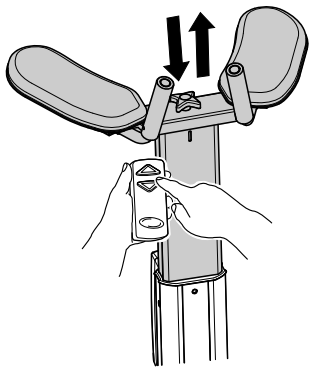

Use the hand control to adjust the support platform upwards or downwards.

 A green light on the control unit indicates that the electrical motor is in use.

4.9 Rising to a standing position



WARNING!

Risk of falling

– Unevenly distributed weight affects the product's stability.

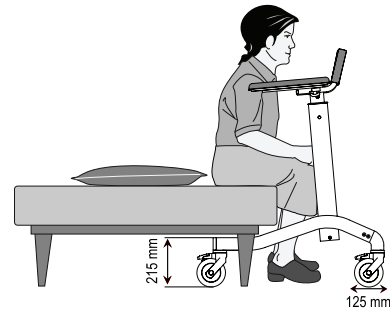

Step Up Electric and Step Up Hydraulic can support the user when rising to a standing position. The help of an attendant is recommended.

1. When the user is seated, roll the back of the walking table under the seat and move it as close as possible in front of the user.
2. The user's feet should be centered between the side frames.
3. Lock the front wheel brakes.
4. The user places the forearms on the forearm support and grabs both handles.
5. While the user is holding the handles, adjust the support platform upwards, until the user is raised to a stable standing position.

5 Accessories

5.1 Accessories General

! **IMPORTANT!**
Use of accessories or spare parts not intended for this product could lead to hazardous situations. Electrical accessories or spare parts not intended for this product may affect the EMC performance.
– Use only original accessories and spare parts.

i Accessories depend on the configuration and might differ per region.

i For spare parts lists, accessories lists and extra user manuals, contact your Invacare distributor.

5.2 Hand Brakes

Models 1521677, 1521678, 1521679, 1536121, 1536122, 1579540

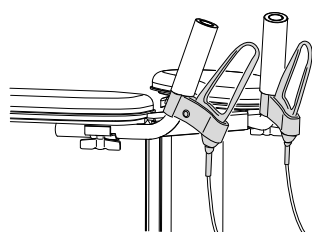

Pair brake

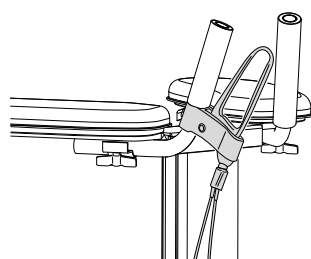

Single brake (one hand brake)

Hand brakes, in pair or single, can be mounted on the handles, to enable users to lock the rear wheels. When a one hand brake (single brake) is used, the brake handle locks both brakes.

Engaging Running Brake

1.

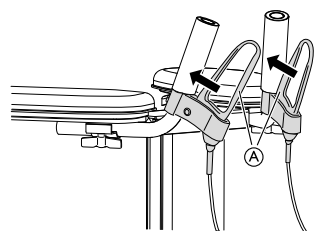

To engage running brake, press brake handle/handles **A** slowly towards handles.

i The more you press, the higher the braking force is.

Engaging Parking Brake

i The parking brake sets the brake into a locked parking position

1.

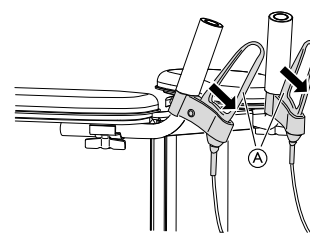

To engage parking brake, press brake handle/handles **A** completely forwards.

2. To release parking brake, press brake handle/handles **A** towards handle/handles.

i A distinct click indicates that the brake is in the correct position, so that the wheels are locked.

5.2.1 Adjusting the brakes



WARNING!

Risk of personal injuries.

If the adjustment is not done properly, the braking effect might not be the expected.

- Make sure the locknuts are properly tightened after adjustment.
- The distance between the wheel and the brake pad should be 2–3 mm.
- Check the braking effect by engaging the parking brake and check that the wheel can't rotate.

i

The brake effect for the pair brake can be adjusted in two places - above under the brake handle or below above the brake clamp. The one hand brake (single brake) can only be adjusted above the brake clamp.

1.

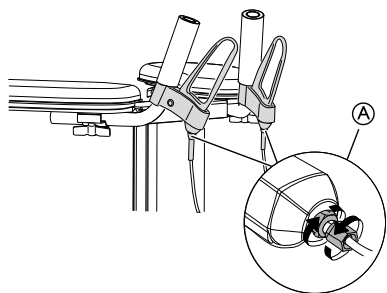

Adjust the brakes with the adjustment nut on the brake handles (A).

2.

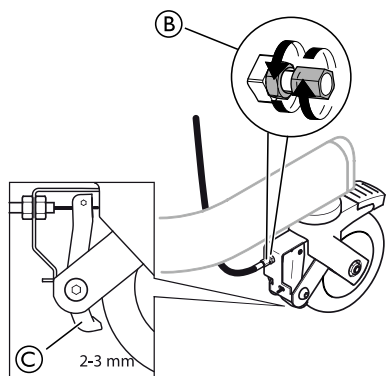

Adjust the brake with the adjustment nut (B) on the brakes.

i The distance between the brake pad (C) and the wheel should be 2–3 mm

i 8 mm and 10 mm spanner (not included).

5.3 Hand Brakes for Models with Directional Lock

Models 1585401, 1587608, 1587609

i Activate the directional lock to prevent the rear wheels from swivelling when using the hand brakes. For more information about how to activate the directional lock, refer to 4.3 Rear Brakes with Integrated Directional Lock, page 7.

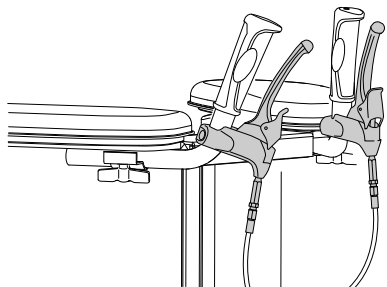

Engaging Running Brake

1.

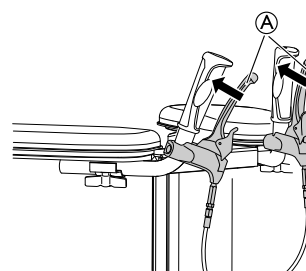

Press brake handle/handles (A) slowly towards handles.

i The more you press, the higher the braking force is.

Engaging Parking Brake

i The parking brake sets the brake into a locked parking position

1.

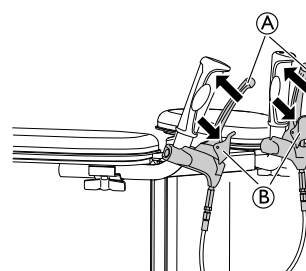

Press brake handle/handles (A) towards handles.

2. Press brake locks (B) outwards/downwards to lock parking brakes.

3. To release parking brake, press brake handle/handles (A) towards handle/handles.

5.3.1 Adjusting the brakes



WARNING!

Risk of personal injuries.

If the adjustment is not done properly, the braking effect might not be the expected.

- Make sure the locknuts are properly tightened after adjustment.
- Check the braking effect by engaging the parking brake and check that the wheel can't rotate.

i The brake effect can be adjusted under the brake handle.

1.

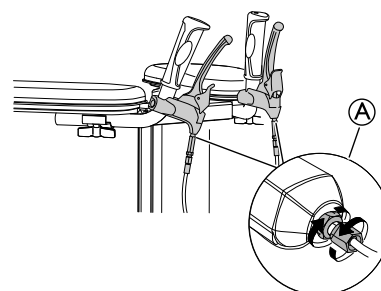

Adjust the brakes with the adjustment nut on the brake handles (A).

i 8 mm and 10 mm spanner (not included).

5.4 Basket

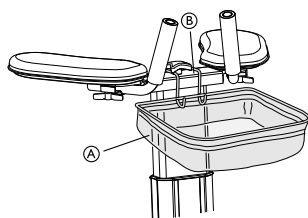

In the basket (A) the user can keep belongings. The basket is simply attached at the top of the platform support (B).

5.5 Tray

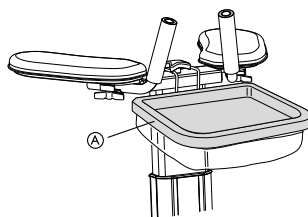

A simple tray (A) is easy to position at the top of the basket.

5.6 Alternative Hand Grips

Models 1521677, 1521678, 1521679, 1536121, 1536122, 1579540

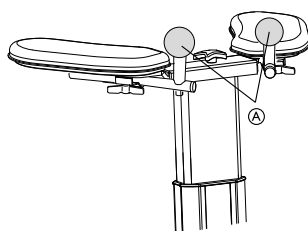

Alternative hand grips (A) are available for those who find it difficult to close their hands around the regular handles.

5.7 Oxygen tank holder

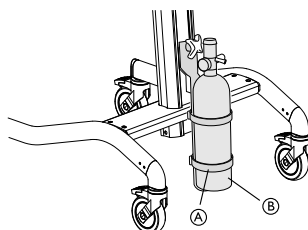

An oxygen tank holder (A) makes it possible to secure an oxygen cylinder (B) on the product. The oxygen holder fits different types of oxygen cylinders. The oxygen tank holder is mounted on the front of the pillar.

- !** **IMPORTANT!**
- When attached to the oxygen holder, the bottom of the oxygen cylinder must be at least 8 cm from the ground.

5.8 IV pole

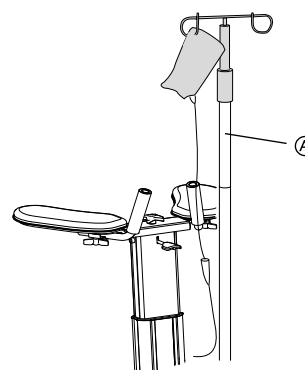

The IV pole can be mounted on the pillar (A) and makes it possible to attach a drip bag on the product.

- i** The Oxygen tank holder and the IV pole can be mounted together.

5.9 Elbow stop

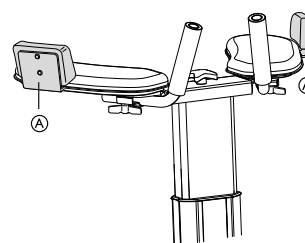

Elbow stops (A) can be used to prevent the arms from sliding off the armrests. The elbow stops are sold in pairs and mounted under the armrest pads.

5.10 Wheel with Directional Lock

Models 1521677, 1521678, 1521679, 1536121, 1536122, 1579540



WARNING!
Risk of falling

When the directional lock is mounted, there is no brake effect on that wheel.
– Only mount the directional lock on one or two wheels.



We recommend to install the directional lock on the rear wheels.

A directional lock (GREEN brake pedal) is used to ease movement straight ahead.

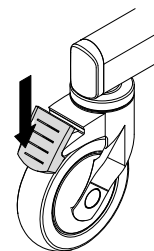

1. Press down brake pedal and swivel wheel until a click is heard and wheel no longer rotates.

5.11 Wheel 100 mm

Models 1521677, 1521678, 1521679, 1536121, 1536122, 1579540

100 mm wheels are available for users who want/need the frame at a lower height.

5.12 Stand Assist

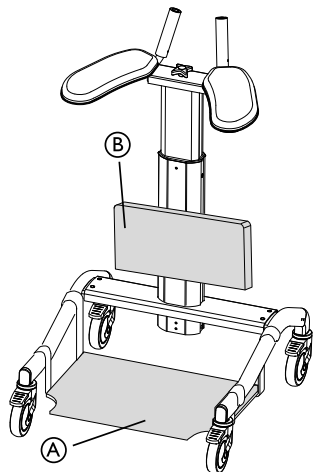

- The Stand Assist accessory is available for users who need support while standing and consists of a standing plate (A), knee support (B) and a harness.
- With the Stand Assist accessory the walking table can be used to turn a user around or for short transfers.

 For more detailed instructions about this accessory, read the separate manual for Stand Assist.

6 Maintenance

6.1 General Maintenance Information



WARNING!
Risk of Injury

- Maintenance should be done at least once a year.
- Do not use a defective product.
- Do not attempt repairs yourself. For repairs contact your provider.

6.2 Inspection Checklist

To ensure good performance and safety, inspect your product regularly.

- Ensure that all screws and adjustments are properly tightened.
- Ensure that hand grips are tight.
If hand grips are loose do not use the walking aid. Instructions on how to change hand grips can be obtained from your provider or Invacare distributor.
- Verify brake operation.
If brake adjustment is required, see chapter 4 *Usage*, page 7.
- Inspect the frame and loaded parts for cracks.
- Inspect the wheels' tightness, wear and damage.
- Make sure that the wheels are free of hair, lint and other debris.

6.3 Cleaning and Disinfection

6.3.1 General Safety Information



CAUTION!
Risk of Contamination

- Take precautions for yourself and use appropriate protective equipment.



IMPORTANT!

- Wrong fluids or methods can harm or damage the product.
- All cleaning agents and disinfectants used must be effective, compatible with one another and must protect the materials they are used to clean.
 - Never use corrosive fluids (alkalines, acid etc.) or abrasive cleaning agents. We recommend an ordinary household cleaning agent such as dishwashing liquid, if not specified otherwise in the cleaning instructions.
 - Never use a solvent (cellulose thinner, acetone etc.) that changes the structure of the plastic or dissolves the attached labels.
 - Always make sure that the product is completely dried before taking it into use again.



For cleaning and disinfection in clinical or long-term care environments, follow your in-house procedures.

6.3.2 Cleaning Intervals



IMPORTANT!

- Regular cleaning and disinfection enhances smooth operation, increases the service life and prevents contamination.
- Clean and disinfect the product
- regularly while it is in use,
 - before and after any service procedure,
 - when it has been in contact with any body fluids,
 - before using it for a new user.

6.3.3 Cleaning Instructions

Step Up Manual and Hydraulic

The product can be washed in a washing machine or by hand.

When using a high-pressure cleaner or an ordinary jet of water, do not aim the jet towards bearings, draining holes or labels.

The maximum cleaning temperature is 60 °C. Do not use a steam cleaner.

1. Clean the walking aid with a damp cloth and mild detergent.
2. Clean the wheels with a brush (no wire brush).
3. After washing, wipe the product dry.

Step Up Electric



IMPORTANT!

- The electrical components of the product are protected according to IPX4.
- Do not wash in a washing plant.
 - Do not soak the electrical parts with water.
 - Wipe the motor, control unit and hand control with a soft dry or moist cloth.

Disinfection

- Wipe down all generally accessible surfaces with disinfectant.



Information on recommended disinfectants and methods can be found on <https://vah-online.de/en/for-users>.

7 After Use

7.1 Reconditioning

This product is suitable for reuse. To recondition the product for a new user, carry out the following actions:

- Inspection
- Cleaning and disinfection

For detailed information, see *6 Maintenance, page 15*.

Make sure that the user manual is handed over with the product.

If any damage or malfunction is detected, do not reuse the product.

7.2 Disposal

**WARNING!****Environmental Hazard**

Device contains batteries.

This product may contain substances that could be harmful to the environment if disposed of in places (landfills) that are not appropriate according to legislation.

- DO NOT dispose of batteries in normal household waste.
- Batteries MUST be taken to a proper disposal site. The return is required by law and free of charge.
- Do only dispose discharged batteries.
- Cover terminals of lithium batteries prior to disposal.
- For information on the battery type see battery label or chapter *8 Technical Data, page 17*.

Be environmentally responsible and recycle this product through your recycling facility at its end of life.

Disassemble the product and its components, so the different materials can be separated and recycled individually.

The disposal and recycling of used products and packaging must comply with the laws and regulations for waste handling in each country. Contact your local waste management company for information.

8 Technical Data

8.1 Dimensions and Weights

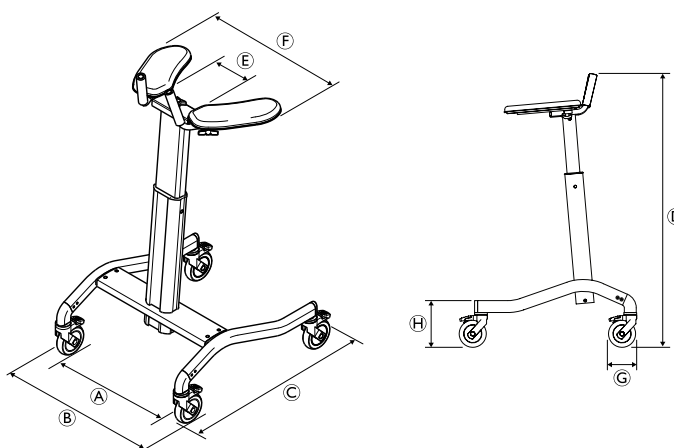

	Step Up Manual 1521677, 1585401	Step Up Hydraulic 1521678, 1536121, 1587608	Step Up Electric 1521679, 1536122, 1579540, 1587609
Ⓐ Inner width, frame (adjustable)	580 - 670 - 760 mm		
Ⓑ Outer width, frame (adjustable)	700 - 790 - 880 mm		
Ⓒ Outer length	825 mm / 890 mm*		
Ⓓ Height	870 - 1320 mm		
Ⓔ Inner width, support platform	340 - 470 mm		
Ⓕ Outer width, support platform	620 - 750 mm		
Ⓖ Wheel diameter	125 mm standard (100 mm optional)		
Ⓗ Height, rear frame	215 mm with standard wheel (190 mm with optional 100 mm wheel)		
Maximum user weight	150 kg		
Maximum load in basket and tray	5 kg		
Maximum load on the oxygen tank holder	11 kg		
Maximum load on the IV pole	4 kg		
Product weight	16 kg	18 kg	23 kg

* For models with integrated directional lock (1585401, 1587608, 1587609)

8.2 Electrical data - Step Up Electric

Battery charger (External / Integrated) - Voltage out	24 V
Battery charger (External / Integrated) - Voltage in	100-240 V, 50-60 Hz
Maximum battery capacity	2,9 Ah
Duty cycle	10%, max. 2 minutes / 18 minutes
Operational duration (on one charge)	Approximately 40 times electrical height adjustment
Degree of protection	IPX4*
Temperature range for operation	+5° C to +40° C

Sound level	48 dB(A)
Type B Applied part	Applied Part complying with the specified requirements for protection against electrical shock according to IEC 60601-1. (An applied parts is a part of the medical equipment which is designed to come into physical contact with the patient or parts that are likely to be brought into contact with the patient.)

*IPX4 classification means that the electrical system is protected against water splashed at the component from any direction.

 The IP-classification of the hand control decides the overall classification of the product.

8.3 Material

Frame	Polyester powder coated aluminium
Handle bars	Anodised aluminium
Handgrips	Foam rubber, TPE (no known allergic reactions)* / PVC**
Arm pads	Dartex (no known allergic reactions)
Wheels	Polyamide with rims of polypropylene and treads of TPE
Plastic parts	Material according to marking (PA, PP, PE)
Screws	Steel, rust protected

* For models 1521677, 1521678, 1536121, 1521679, 1536122, 1579540

** For models 1585401, 1587608, 1587609

8.4 Environmental conditions



WARNING!

Step Up Electric may only be used in wet areas when it runs on battery.

- Do not use Step Up Electric in wet areas while it is connected to the mains.
- Make sure the walking table is dry before connection it to the mains.

	Operation	Storage	Transportation
Temperature	+5°C to +40°C	-10°C to +50°C	-10°C to +50°C
Relative humidity	20% to 100%	20% to 75%	20% to 75%
Atmospheric pressure	700 hPa to 1060 hPa		

The walking table may be used in wet areas, but not under pouring water (e.g. shower).

8.5 Electromagnetic compliance (EMC)

General information

Products with electronic equipment needs to be installed and used according to the EMC information in this user manual.

 **WARNING!**
Portable and mobile communications equipment can affect the operation of this product.
 This product must not move unintentionally while being submitted to Electromagnetic interference
 – If this should happen; the product must immediately be taken out of use and checked by a qualified technician.

This product has been tested and complies with the EMC limits specified by IEC 60601-1-2 for Class B equipment.

 **This product has a very low emission and should not interfere with other equipment.**

However, if other devices nearby should react inexplicably, run and stop this product and observe the devices.

- If nothing happens with the other devices, then this product is not causing the error.
- If other devices are behaving in an inexplicable manner, then this product is causing the error. Solve the problem by moving or increasing the distance between them.

8.6 Electromagnetic compliance (EMC) - Guidance and manufacturer's declaration

Guidance and manufacturer's declaration – electromagnetic emission

This product is intended for use in the electromagnetic environment as specified below. The user of the product should assure that it is used in such an environment.

Emissions test	Compliance	Electromagnetic environment - guidance
RF emissions CISPR 11	Group I	The product uses RF energy only for its internal function. Therefore, its RF emissions is very low and not likely to cause any interference in nearby electronic equipment. The product is suitable for use in all establishments, including domestic and those directly connected to the public low-voltage power supply network that supplies buildings used for domestic purposes.
RF emissions CISPR 11	Class B	
Harmonic emissions IEC 61000-3-2	Not applicable	Not applicable
Voltage fluctuations /flicker emissions IEC 61000-3-3	Not applicable	Not applicable

Guidance and manufacturer's declaration – electromagnetic immunity

This product is intended for use in the electromagnetic environment specified below. The user of the product should assure that it is used in such an environment.

Immunity test	IEC 60601-1-2 test level	Compliance level	Electromagnetic environment – guidance
Electrostatic discharge (ESD) IEC 61000-4-2	± 6 kV contact ± 8 kV air	± 6 kV contact ± 8 kV air	Floors should be wood, concrete, ceramic tile or synthetic material.
Electrostatic transient / burst IEC 61000-4-4	± 2 kV on AC power port ± 1 kV for signal and inter-connection cables	± 2 kV for power supply lines ± 1 kV for input/output lines	Mains power quality should be that of a typical commercial, domestic or hospital environment.  U_T is the AC mains voltage prior to application of the test level.
Surge IEC 61000-4-5	± 1 kV differential mode on AC power port	± 1 kV differential mode	
Voltage dips, short interruptions and voltage variations on power supply input lines IEC 61000-4-11	0 % U_T (>100 % dip in U_T) for 10ms 40 % U_T (60% dip in U_T) for 100 ms 70 % U_T (30% dip in U_T) for 500 ms 0 % U_T (>100 % dip in U_T) for 5 sec	0 % U_T (>100 % dip in U_T) for 10ms 40 % U_T (60% dip in U_T) for 100 ms 70 % U_T (30% dip in U_T) for 500 ms 0 % U_T (>100 % dip in U_T) for 5 sec	
Power frequency (50/60 Hz) magnetic field IEC 61000-4-8	3 A/m	3 A/m	Power frequency magnetic fields should be at levels characteristic of a typical location in a typical commercial, domestic or hospital environment.

Conducted RF IEC 61000-4-6	3 V 0,150 - 80 MHz	3 V	Portable and mobile RF communications equipment should be used no closer to any part of the product including cables, than the recommended separation distance calculated from the equation applicable to the frequency of the transmitter. Recommended separation distance: $d = \left[\frac{3,5}{3} \right] \sqrt{P}$ $d = \left[\frac{3,5}{3} \right] \sqrt{P} \quad 80 - 800 \text{ MHz}$ $d = \left[\frac{7}{20} \right] \sqrt{P} \quad 800 - 2700 \text{ MHz}$ where P is the maximum output power rating of the transmitter in watts (W) according to the transmitter manufacturer and d is the recommended separation distance in metres (m). ^b
Radiated RF IEC 61000-4-3	3 V/m 80 - 800 MHz	3 V/m	
[Requirements according to EN12182:2012, subclause 7.3)	20 V/m 800 - 2700 MHz	20 V/m	

Field strengths from fixed RF transmitters, as determined by an electromagnetic site survey^a, should be less than the compliance level in each frequency range.^b



Interference may occur in the vicinity of equipment marked with the following symbol:

^a Field strengths from fixed transmitters, such as base stations for radio (cellular/cordless) telephones and land mobile radios, amateur radio, AM and FM radio broadcast and TV broadcast cannot be theoretically predicted with accuracy. To assess the electromagnetic environment due to fixed RF transmitters, an electromagnetic site survey should be considered. If the measured field strength, in the location in which this product is used, exceeds the applicable RF compliance level above, the product should be observed to verify normal operation. If abnormal performance is observed, additional measures may be necessary, such as reorienting or relocating the product.

^b Over the frequency range 0,15 - 80 MHz, field strengths should be less than 3 V/m.

Recommended separation distances between portable and mobile RF communications equipment and this product

This product is intended for use in an electromagnetic environment in which radiated RF disturbances are controlled. The user of the product can prevent electromagnetic interference by maintaining a minimum distance between portable and mobile RF communications equipment (transmitters) and this product as recommended below, according to the maximum output power of the communications equipment.

Rated maximum output of transmitter [W]	Separation distance according to frequency of transmitter [m]		
	0,150 - 80 MHz $d = 1,167 \sqrt{P}$	80 - 800 MHz ^c $d = 1,167 \sqrt{P}$	800 - 2700 MHz $d = 0,35 \sqrt{P}$
0,01	0,12	0,12	0,04
0,1	0,37	0,37	0,11
1	1,17	1,17	0,35
10	3,69	3,69	1,11
100	11,67	11,67	3,50

^c At 80 MHz and 800 MHz, the higher frequency range applies.

For transmitters rated at a maximum output power not listed above, the recommended separation, distance d in metres (m) can be estimated using the equation applicable to the frequency of the transmitter, where P is the maximum output power rating of the transmitter in watts (W) according to the transmitter manufacturer.

- At 80 MHz and 800 MHz, the separation distance for the higher frequency range applies.
- These guidelines may not apply in all situations. Electromagnetic propagation is affected by absorption and reflection from structures, objects and people.

Invacare Sales Companies

Ireland:

Invacare Ireland Ltd,
Unit 5 Seatown Business
Campus
Seatown Road, Swords, County
Dublin
Tel : (353) 1 810 7084
Fax: (353) 1 810 7085
ireland@invacare.com
www.invacare.ie

United Kingdom:

Invacare Limited
Pencoed Technology Park,
Pencoed
Bridgend CF35 5AQ
Tel: (44) (0) 1656 776 222
Fax: (44) (0) 1656 776 220
uk@invacare.com
www.invacare.co.uk



Manufacturer:

Invacare Rea AB
Växjövägen 303
SE-343 71 Diö
Sweden

1532567-G 2020-05-14



Making Life's Experiences Possible®

Dolomite



Yes, you can.®