

Rea® Focus™

Rea®Focus™, Rea®Focus™150



en **Manual wheelchair**
User Manual



This manual **MUST** be given to the user of the product.
BEFORE using this product, this manual **MUST** be read and saved
for future reference.

rea®



Yes, you can.®

©2022 Invacare Corporation

All rights reserved. Republication, duplication or modification in whole or in part is prohibited without prior written permission from Invacare. Trademarks are identified by [™]and [®]. All trademarks are owned by or licensed to Invacare Corporation or its subsidiaries unless otherwise noted.

Contents

1 General	4	5.3 Fitting the rear wheels	29
1.1 Introduction	4	5.4 Fitting the seat	29
1.2 Symbols in This Manual	4	5.5 Fitting the backrest bar	29
1.3 Warranty Information	4	5.6 Fitting the armrests	29
1.4 Limitation of Liability	4	5.7 Fitting the legrests	30
1.5 Compliance	4	5.7.1 Fixed leg rests	30
1.5.1 Product-specific standards	4	5.7.2 Angle adjustable leg rests	30
1.6 Service Life	4	6 Using the wheelchair	31
2 Safety	5	6.1 Safety information	31
2.1 Safety information	5	6.2 Braking During Use	31
2.2 Safety Devices	6	6.3 Move to/from the wheelchair	32
2.3 Labels and symbols on the product	6	6.4 Driving and Steering the Wheelchair	32
3 Product Overview	7	6.5 Negotiating steps and kerbs	33
3.1 Product Description	7	6.6 Going up and down stairs	34
3.2 Intended use	7	6.7 Negotiating Ramps and Slopes	34
3.3 Main Parts of the Wheelchair	7	6.8 Stability and balance when seated	35
3.4 Parking Brakes	8	7 Transport	36
3.5 Backrest	8	7.1 Safety information	36
3.6 Adjusting the Backrest Height	8	7.2 Folding the backrest bar	36
3.6.1 Fixed and Tension Adjustable Backrest	8	7.3 Removing the armrests	36
3.6.2 Biangular Backrest	9	7.4 Folding the seat	36
3.6.3 Reclining Backrest	9	7.5 Fixed leg rests	36
3.7 Adjusting the Shape — Tension Adjustable Backrest	10	7.6 Angle adjustable leg rests	36
3.8 Adjusting the Backrest Angle	10	7.7 Brake lever	36
3.8.1 Angle adjustable backrest	11	7.8 Remove the rear wheels	36
3.8.2 Biangular backrest	11	7.9 Lifting the wheelchair	37
3.8.3 Reclining Backrest	11	7.10 Transporting the Mobility Device without Occupant	37
3.9 Adjusting the push handles	12	7.11 Transporting the Occupied Wheelchair in a Vehicle	37
3.10 Armrests	12	8 Maintenance	41
3.10.1 Flip-up armrests	13	8.1 Safety information	41
3.10.2 Detachable armrests	13	8.2 Maintenance Schedule	41
3.10.3 Height adjustable armrests	13	8.3 Tightening torques	42
3.11 Adjusting the seat depth	13	8.4 Cleaning and Disinfection	43
3.12 Adjusting the seat width	13	8.4.1 General Safety Information	43
3.13 Adjusting the seat	14	8.4.2 Cleaning Intervals	43
3.14 Leg rests	14	8.4.3 Cleaning	43
3.14.1 Swing away leg rests	14	8.4.4 Disinfection	43
3.14.2 Swing Away, Angle Adjustable Leg Rests	15	9 Troubleshooting	44
3.14.3 Adjusting the amputee legrest	16	9.1 Safety information	44
3.14.4 Adjusting the one-piece footrest	16	9.2 Identifying and Repairing Faults	45
3.15 Seat cushion	17	10 After Use	46
4 Options	18	10.1 Storage	46
4.1 Inlay cushion seat	18	10.2 Reconditioning	46
4.2 Trunk support Swing away	18	10.3 Disposal	46
4.3 Trunk support fixed arm	18	11 Technical Data	47
4.4 Headrest / Neckrest	19	11.1 Dimensions and weights	47
4.4.1 Biangular backrest	19	11.1.1 Maximum Weight of Removable Parts	48
4.4.2 Reclining backrest	19	11.2 Tyres	48
4.5 Tipper aid	23	11.3 Material	48
4.6 Table tray	23	11.4 Environmental conditions	49
4.6.1 Mounting the attachment for table tray	24	11.5 Seat height tables	49
4.6.2 Adjusting the depth of the table tray	24	11.5.1 Rea Focus High — 515 x 35 mm (20 x 1 3/8")	49
4.6.3 Locking the table tray	24	11.5.2 Rea Focus High — 560 x 35 mm (22 x 1 3/8")	49
4.7 Add a table tray cushion	24	11.5.3 Rea Focus High — 560 x 25 mm (22 x 1")	50
4.8 Anti-tipper	25	11.5.4 Rea Focus High — 610 x 35 mm (24 x 1 3/8")	51
4.8.1 Mounting anti-tip device swing-away	25	11.5.5 Rea Focus High — 610 x 25 mm (24 x 1")	51
4.8.2 Anti-tipper swing-away	25	11.5.6 Rea Focus Low — 515 x 35 mm (20 x 1 3/8")	52
4.8.3 Anti-tip device regular	26	11.5.7 Rea Focus Low — 560 x 35 mm (22 x 1 3/8")	52
4.9 Hemiplegic armrest	26	11.5.8 Rea Focus Low — 560 x 25 mm (22 x 1")	53
4.10 Lateral positioning pads (for adjustable backrest cover only)	27	11.5.9 Rea Focus Low — 610 x 35 mm (24 x 1 3/8")	54
4.11 Posture belt	27	11.5.10 Rea Focus Low — 610 x 25 mm (24 x 1")	54
4.11.1 Posture belt mounting	28		
4.12 Air pump	28		
4.13 Passive illumination	28		
4.14 Cane holder	28		
5 Setup	29		
5.1 Safety information	29		
5.2 Delivery check	29		

1 General

1.1 Introduction

This user manual contains important information about the handling of the product. To ensure safety when using the product, read the user manual carefully and follow the safety instructions.

Only use this product if you have read and understood this manual. Seek additional advice from a healthcare professional who is familiar with your medical condition and clarify any questions regarding the correct use and necessary adjustment with the healthcare professional.

Note that there may be sections in this document, which are not relevant to your product, since this document applies to all available models (on the date of printing). If not otherwise stated, each section in this document refers to all models of the product.

The models and configurations available in your country can be found in the country-specific sales documents.

Invacare reserves the right to alter product specifications without further notice.

Before reading this document, make sure you have the latest version. You find the latest version as a PDF on the Invacare website.

If you find that the font size in the printed document is difficult to read, you can download the PDF version from the website. The PDF can then be scaled on screen to a font size that is more comfortable for you.

For more information about the product, for example product safety notices and product recalls, contact your Invacare distributor. See addresses at the end of this document.

In case of a serious incident with the product, you should inform the manufacturer and the competent authority in your country.

1.2 Symbols in This Manual

Symbols and signal words are used in this manual and apply to hazards or unsafe practices which could result in personal injury or property damage. See the information below for definitions of the signal words.



WARNING

Indicates a hazardous situation that could result in serious injury or death if it is not avoided.



CAUTION

Indicates a hazardous situation that could result in minor or slight injury if it is not avoided.



NOTICE

Indicates a hazardous situation that could result in damage to property if it is not avoided.



Tips

Gives useful tips, recommendations and information for efficient, trouble-free use.



Tools

Identifies required tools, components and items which are needed to carry out certain work.

Other Symbols

(Not applicable for all manuals)



UK Responsible Person

Indicates if a product is not manufactured in the UK.



Triman

Indicates recycling and sorting rules (only relevant for France).

1.3 Warranty Information

We provide a manufacturer's warranty for the product in accordance with our General Terms and Conditions of Business in the respective countries.

Warranty claims can only be made through the provider from whom the product was obtained.

1.4 Limitation of Liability

Invacare accepts no liability for damage arising from:

- Non-compliance with the user manual
- Incorrect use
- Natural wear and tear
- Incorrect assembly or set-up by the purchaser or a third party
- Technical modifications
- Unauthorised modifications and/or use of unsuitable spare parts

1.5 Compliance

Quality is fundamental to the company's operation, working within the disciplines of ISO 13485.

This product features the CE mark, in compliance with the Medical Device Regulation 2017/745 Class I.

We are continuously working towards ensuring that the company's impact on the environment, locally and globally, is reduced to a minimum.

We only use REACH compliant materials and components.

1.5.1 Product-specific standards

The wheelchair has been tested in accordance with EN 12183. It includes testing for flammability.

For further information about local standards and regulations, contact your local Invacare representative. See addresses at the end of this document.

1.6 Service Life

The expected service life of this product is five years when used daily and in accordance with the safety instructions, maintenance intervals and correct use, stated in this manual. The effective service life can vary according to frequency and intensity of use.

2 Safety

2.1 Safety information

This section contains important safety information for the protection of the wheelchair user and assistant and for safe, trouble-free use of the wheelchair.



WARNING!

Risk of death or serious injury

In case of fire or smoke, wheelchair occupants are at particular risk of death or serious injury, when they are not able to move away from the source of fire or smoke. Lighted matches, lighter and cigarettes can cause an open flame in the wheelchair surroundings or on clothes.

- Avoid using or storing the wheelchair near open flames or combustible products.
- Do not smoke while using the wheelchair.



WARNING!

Risk of accidents and serious injury

Accidents with resulting serious injury can occur if the wheelchair is wrongly adjusted.

- Contact your wheelchair provider in order to a qualified technician does the adjustments needed.



WARNING!

Risk of overturning

The longitudinal position of the rear wheels axis compared to the backrest position affects the wheelchair stability.

- Moving the rear wheels axis frontwards makes the wheelchair less stable, increasing the risk of tipping backwards. But it improves the manoeuvrability with a better grip position of the handrim and a short turning radius.
- Moving the rear wheels axis backwards makes the wheelchair more stable, and it will tilt less easily. But it reduces the manoeuvrability.
- Depending on your particular abilities and safety limits, you can install an anti-tipper device to compensate the decrease of stability.



WARNING!

Risk of tilting

The rear wheel axle position and the angle of your wheelchair's backrest are two of the key adjustments that can affect your stability.

- The changes of rear/front wheels position and/or angle fork adjustments must only be performed by a qualified technician after the assessment of your healthcare professional.



WARNING!

Risk due to driving style being unsuitable for environmental the conditions

There is a risk of skidding on wet ground, gravel or uneven terrain.

- Always adjust your speed and driving style to the conditions (weather, surface, individual ability, etc.).



WARNING!

Risk of injury

In a collision you could sustain injury to parts of your body that extend beyond the wheelchair (e.g. feet or hands).

- Avoid an unbraked collision.
- Never drive into an object head-on.
- Drive carefully through narrow passages.



WARNING!

Risk due to wheelchair being out of control

At high speed you could lose control of your wheelchair and overturn.

- Never exceed a speed of 7 km/h.
- Avoid collisions in general.



CAUTION!

Risk of burning

The wheelchair components can heat up when exposed to external sources of heat.

- Do not expose the wheelchair to strong sunlight before use.
- Before use, check all components that come into contact with your skin for their temperature.



CAUTION!

Risk of getting parts of body caught

There is always a risk of getting parts of the body e.g. fingers or arms, caught in the moving parts of the wheelchair.

- Take attention while activating and deactivating the mechanisms of moving parts, such as the removable axle of the rear wheel, folding backrest or anti-tipper.



WARNING!

Risk of tipping

The hanging of additional load (back pack or similar items) onto your wheelchair back posts can affect the rearward stability of your wheelchair. This can cause the chair to tip backwards causing injury.

- Try to avoid putting additional load in the back of the wheelchair.
- We strongly recommend the use of anti-tippers when using your back posts with additional load.



CAUTION!

Risk of injury

– In case of pressure sore or injured skin, protect your injures to avoid a direct contact with the fabrics of the device. Refer to a healthcare professional for medical advice.



CAUTION!

Risk of injury

When combining the wheelchair with another device, the restrictions of both devices apply for the combination. E.g. If the maximum user weight of the two device are different, apply always the lowest for the combination.

- Only use combinations with other devices which are allowed by Invacare. Contact your authorized provider for more information.
- Before use, read the user manual of each device and check the restrictions.

2.2 Safety Devices



WARNING!

Risk of accidents

Safety devices that are incorrectly set or no longer working (brakes, anti-tipper) can cause accidents.

- Always check that the safety devices are working before you use the wheelchair and have them checked regularly by a qualified technician or your authorized provider.



CAUTION!

Risk of Injury

Non-original or wrong parts may affect the function and safety of the product.

- Only use original parts for the product in use.
- Due to regional differences, refer to your local Invacare catalogue or website for available options or contact your Invacare distributor. See addresses at the end of this document.

The functions of the safety devices are described in chapter 3 *Product Overview*, page 7.

2.3 Labels and symbols on the product

Identification label

The identification label is attached to the frame of your wheelchair and gives the following information:

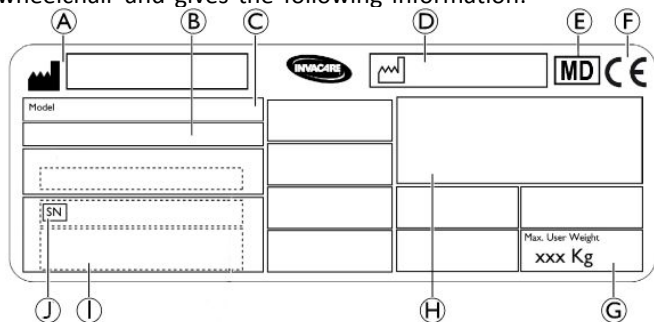

- (A) Manufacturer's address
- (B) Seat width
- (C) Product description
- (D) Date of manufacture
- (E) Medical device
- (F) European conformity
- (G) Maximum user weight
- (H) EAN/HMI barcode
- (I) Serial number barcode
- (J) Serial number

	Read user manual
	Indicates a hazardous situation that could result in serious injury or death if it is not avoided.

Non-locking side parts warning label

	Do not lift the wheelchair by non-locking side parts.
--	---

Posture belt information label

	The posture belt has the good length, when there's just sufficient space for a flat hand between body and belt.
--	---

Snap hook symbols

Depending on the configuration, some wheelchairs may be used as a seat in a motor vehicle, some may not.

	Tie-down positions where the restraint system straps must be placed in case of transporting the occupied wheelchair in a motor vehicle. This symbol is only attached to the wheelchair when it is ordered with the transportation kit option.
--	---

	WARNING Symbol This wheelchair is not configured for passenger transport in a motor vehicle. This symbol is attached to the frame close to the identification label.
--	--

3 Product Overview

3.1 Product Description

This is a medium active wheelchair with horizontal folding mechanism, firm seat plate foldable and swing-away leg rests.

! NOTICE!

The wheelchair is manufactured and configured individually to the specifications in the order. The specification must be performed by a healthcare professional according to the user's requirements and health condition.

- Consult a healthcare professional if you intend to adapt the wheelchair configuration.
- Any adaptation should be performed by a qualified technician.

3.2 Intended use

The medium active wheelchair is intended to provide mobility to persons limited to a sitting position, who are propelling the wheelchair themselves frequently.

The wheelchair may be used indoors and outdoors on level ground and accessible terrain.

Intended users

The wheelchair is intended for persons ages 12 and up (adolescents and adults). The weight of the wheelchair occupant must not exceed the maximum user weight as stated in the Technical Data section and on the identification label.

The intended user is the wheelchair occupant and/or an assistant.

The user should physically and mentally be able to use the wheelchair safely (e.g. to propel, steer, brake).

Indications/ contra-indications

- Considerable to complete impairment of mobility due to structural and/or functional damage to the lower extremities.
- Sufficient strength and gripping function of arms and hands to propel the wheelchair.

There are no contra-indications known, when using the wheelchair as intended.

3.3 Main Parts of the Wheelchair

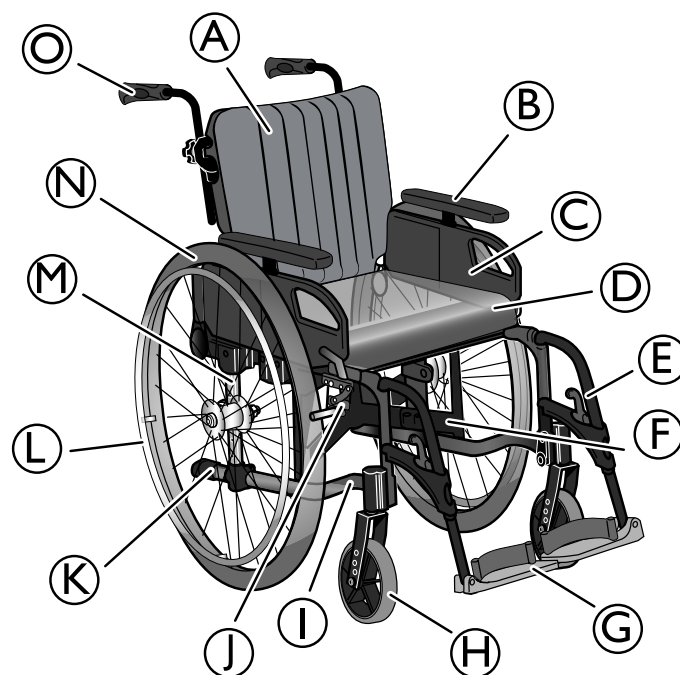

- Ⓐ Backrest upholstery
- Ⓑ Armrest
- Ⓒ Side guards
- Ⓓ Seat
- Ⓔ Leg rest, swiveling
- Ⓕ Cross brace
- Ⓖ Footrests
- Ⓗ Castor
- Ⓘ Frame
- Ⓝ Parking brake
- Ⓚ Anti-tipper
- Ⓛ Handrim
- Ⓜ Rear wheel attachment
- Ⓝ Rear wheel
- Ⓞ Push handles



The equipment of your wheelchair may differ from the diagram as each wheelchair is manufactured individually to the specifications in the order.

3.4 Parking Brakes

The parking brakes are used to immobilize the wheelchair when it is stationary to prevent it from rolling away.



WARNING!

Risk of overturning if you brake sharply

If you engage the parking brakes while you are moving, the direction of movement can become uncontrollable and the wheelchair may stop suddenly, which can lead to a collision or to you falling out.

- Never engage the parking brakes while you are moving.



WARNING!

Risk due to wheelchair being out of control

- The parking brakes must be operated simultaneously.
- Do not engage the parking brakes to slow down the wheelchair.



WARNING!

Risk of overturning

The parking brakes will not operate correctly unless there is sufficient air in the tyres.

- Ensure the correct tyre pressure, *11.2 Tyres, page 48.*



CAUTION!

Risk of pinching or crushing

There may be a very small gap between the rear wheel and the parking brake with the risk that you could trap your fingers.

- Keep your fingers away from movable parts when using the brake, always keep your hand on the brake lever.



The distance between the brake shoe and the tyre can be adjusted. The adjustment must be carried out by a qualified technician.

To operate the brake, refer to paragraph Using the wheelchair, section 6.2 *Braking During Use, page 31.*

3.5 Backrest

There are three types of backrest (Fixed, Angle adjustable and Reclining) available.



WARNING!

Risk of serious injury

Tilting up with a user of more than 125 kg can fatigue, bend or break the wheelchair backrest.

- Avoid tilting up the wheelchair with a user weight of more than 125 kg.

3.6 Adjusting the Backrest Height



WARNING!

Risk of tipping

The hanging of additional load (back pack or similar items) onto your wheelchair back posts can affect the rearward stability of your wheelchair. This can cause the chair to tip backwards causing injury.

- Therefore, Invacare strongly recommend the use of anti-tippers (available as an option) when using your back posts with additional load (back pack or similar items).



The height of the backrest cover can be adjusted on the back posts. The adjustment must be carried out by a qualified technician.



WARNING!

Safety risk

- Always make sure that the backrest is securely locked in its position.

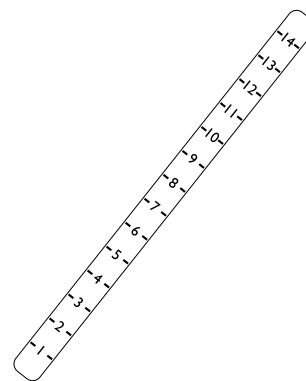

The sticker placed on the backrest tubes is a help in order to set the same height on both sides. The sticker is cut into different sizes depending on the type of backrest.

3.6.1 Fixed and Tension Adjustable Backrest



WARNING!

Risk of tipping

If the standard backrest cover become slack, the tipping point of your wheelchair is changed for the worse.

- Slack standard backrest cover must be replaced by a qualified technician.

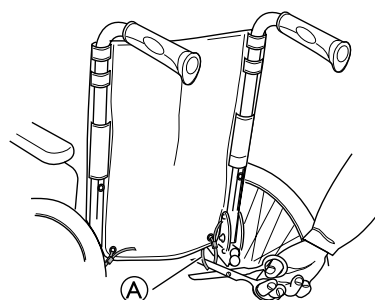

1. Remove the plastic ties **(A)** at the bottom of the backrest cover.

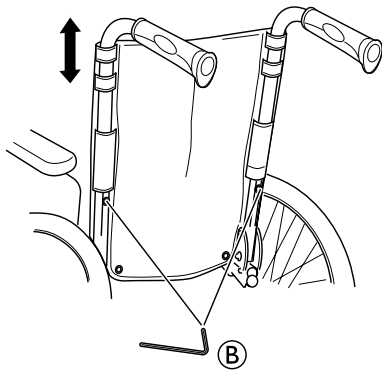

2. Loosen the screws **(B)** on the backrest tubes .
3. Lower or raise the backrest to the desired position.
4. Re-tighten the screws **(B)** again.



- 5 mm Allen key
- A pair of scissors

i Adjust the backrest upholstery in order for it to cover the backrest as much as possible.

i Secure the backrest cover with new plastic ties after adjustment and tighten them well.

3.6.2 Biangular Backrest

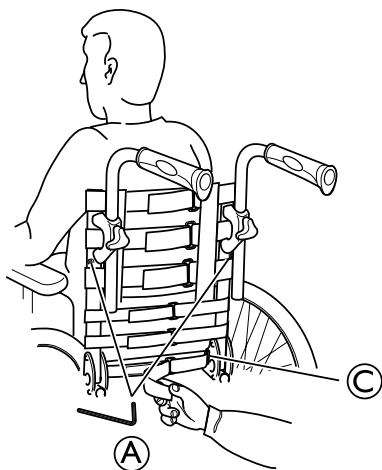

1. Loosen the screws **(A)**.
2. Adjust the backrest to the desired position.
3. Re-tighten the screws **(A)**.

i When the backrest is adjusted in height, the lower hook and loop straps might need to be adjusted.

4. If needed, fold down the hook and loop upholstery and remove the unnecessary straps.

i The bottom hook strap must be pulled through the slot at the front of the backrest attachment **(C)**. It prevents the upholstery from sliding upwards.

3.6.3 Reclining Backrest



WARNING!
Risk of tipping

Do not move the wheelchair when the backrest is in reclined position.
– Invacare strongly recommend the use of anti-tippers (available as an option) when the backrest is in reclined position .



WARNING!
Risk of injury

The backrest is not secured
– The reclining backrest has two safety clamps which will secure the backrest to the backrest tubes. Make sure that the backrest is secured in its position and that the safety clamps are secured after each adjustment.

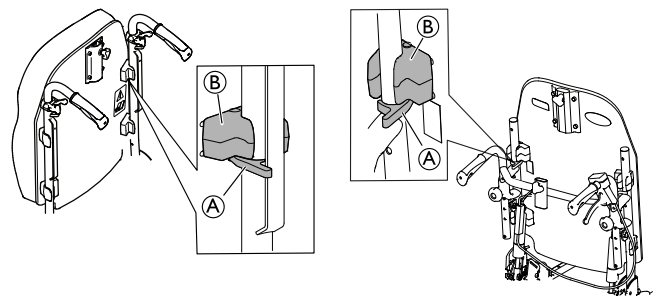

Reclining backrest without gas spring

Reclining backrest with gas spring

1. Release the two safety clamps **(A)** from the backrest tubes.

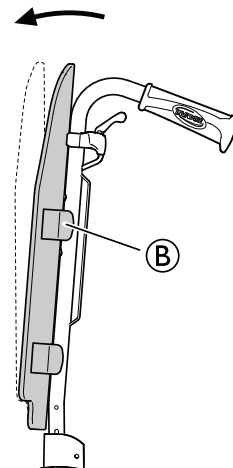

2. Release the two top attachments **(B)** from the backrest tubes.

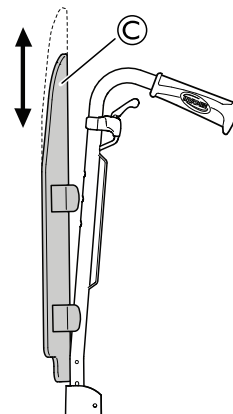

- Adjust to the desired height by sliding the backrest © up or down on the backrest tubes.
 - The reclining backrest without gas spring can be adjusted in three fixed positions (0, 40 and 80 mm)
 - The reclining backrest with gas spring can be adjusted in two fixed positions (0 + 40 mm).

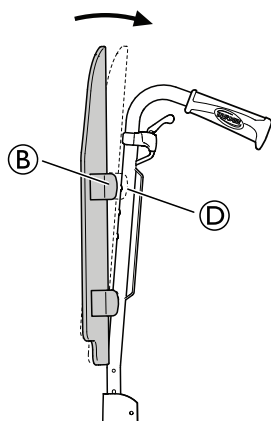

- Fit the pins of the upper attachments ⑥ in the holes of the backrest tubes ⑦.

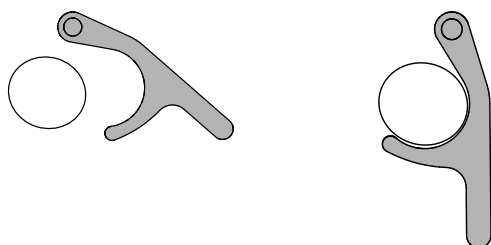

Safety clamp ① released Safety clamp ① secured

- Secure the two safety clamps ① again.

3.7 Adjusting the Shape — Tension Adjustable Backrest

i The shape of the tension adjustable backrest can be adjusted with the hook and loop straps. For example the straps in the lumbar region could be tightened to provide a good support to the sway-back and enable a more upright sitting position.

- Fold the backrest cover away from the hook and loop backrest.

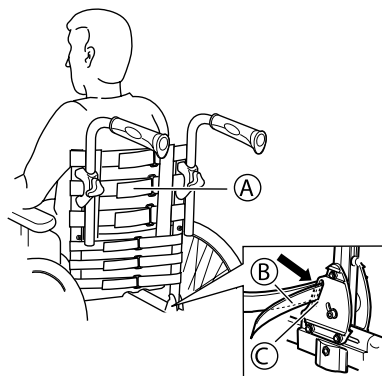

- Adjust the hook and loop straps ① to the desired shape.

i The user must be seated in the wheelchair in order to adjust the backrest to satisfy the users need concerning support and comfort.

- Fixate the lowest hook strap in the backrest brackets © after adjustment. This fixates the hook and loop backrest.
- Fold back the backrest cover and attach the cover with the hook strap.



WARNING!
Risk of tipping

If the bands are set very loose, the tipping point of your wheelchair is changed for the worse.
– Ensure that the bands are set correctly.



NOTICE!

– Do not overtighten the bands; this is to ensure that the geometry of the wheelchair is not changed.



NOTICE!

– Only ever tighten the bands when the wheelchair is unfolded.

3.8 Adjusting the Backrest Angle



WARNING!
Safety risk

– Always make sure that the backrest is securely locked in its position.



The backrest angle adjustment must be carried out by a qualified technician.



WARNING!
Risk of tipping

Do not move the wheelchair when the backrest is in reclined position.
– Invacare strongly recommend the use of anti-tippers (available as an option) when the backrest is in reclined position .



WARNING!
Risk of injury

– Invacare strongly recommends the use of anti-tippers (available as an option) in combination with all rear wheel positions when you use your backrest with an angle of 12° and more



CAUTION!
Risk of uncomfortable posture

An angle less than 90° between the seat and the backrest is uncomfortable for certain users.
– This adjustment must be performed by a qualified technician upon agreement by a prescribing physician. Please consult with your provider.

3.8.1 Angle adjustable backrest

1.

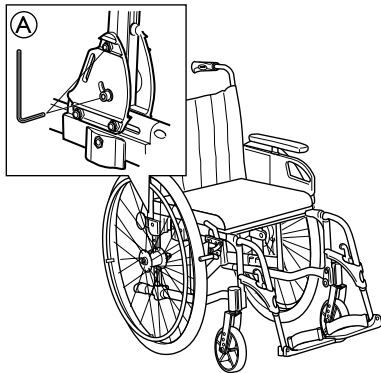

Loosen the screw **A** on the inside of the backrest attachment.

2.

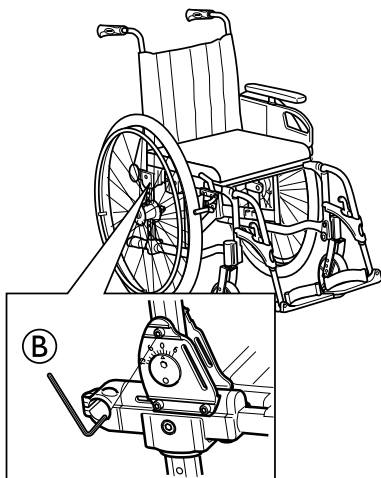

Loosen the screw **B** on the outside of the backrest attachment.

3.

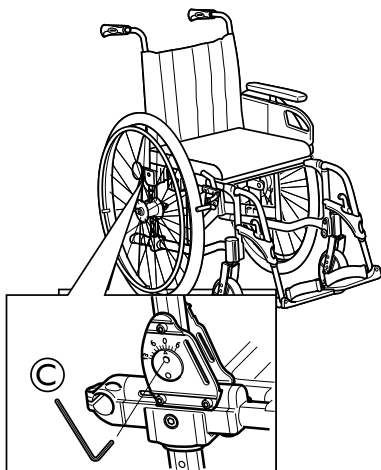

Turn the dial **C** to adjust the angle.

 The angle can be adjusted 6° forward and 13° backward.

4. Tighten the screws again with 10 Nm.
5. Repeat the procedure on the opposite side.

 5 mm allen key

3.8.2 Biangular backrest

The biangular backrest have two possible angle adjustments:

- Angle adjustment on the upper joint
- Angle adjustment on the lower joint

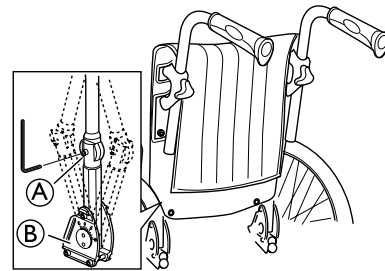

1. Loosen the screw **A**.
2. Adjust the upper joint to the desired angle.
3. Re-tighten the screw **A** with 10 Nm.

 See section “Angle adjustable backrest” for instructions on how to adjust the angle on the lower joint **B**.

 5 mm allen key

3.8.3 Reclining Backrest

The angle of the backrest can be adjusted in four steps (0° to 30°) with the mechanical version, and step less with the gas struts version.



WARNING!

Risk of injury

- Always make these adjustments before the user settles down in the wheelchair to prevent injuries.
- Invacare strongly recommends the use of anti-tippers (available as an option) in combination with all rear wheel positions when you use your backrest with an angle of 12° and more



CAUTION!

Risk of pinching or crushing fingers

- There is always a risk of getting fingers pinched in mechanical parts of the wheelchair.
- Be careful when activating the control levers of the reclining backrest.



NOTICE!

- Push on the backrest canes before operating the levers, this is to release the auto-locked security system of the mechanical version.



WARNING!

Risk of tipping backwards

- Adjust the rear wheels to achieve a stable position and use anti-tipper devices.

Backrest mechanical version:

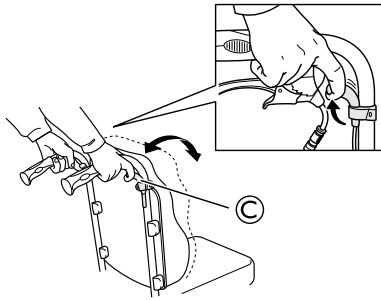

1. Release the auto-locked system by pushing on the backrest canes.
2. Simultaneously pull the control levers (B) to provides the same angle on both sides.
3. Release the levers when you reach the desired angle.

Backrest gas struts version:

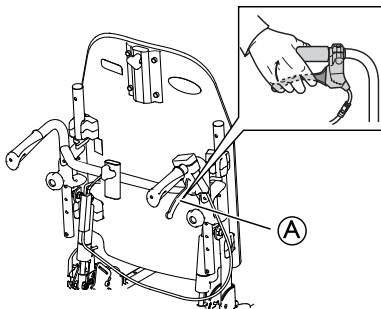

1. Press the lever (A) and adjust the backrest to the desired angle.

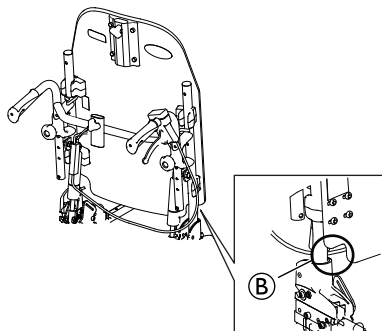

3.9 Adjusting the push handles

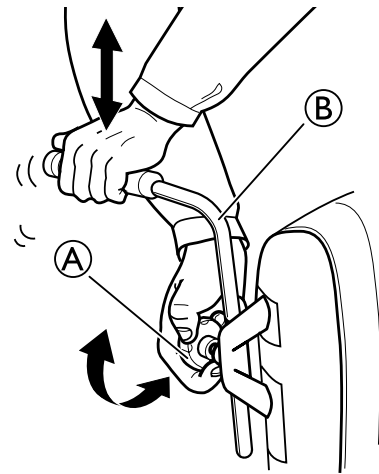

1. Loosen the knob (A).
2. Adjust the push handle (B) to the required position.
3. Re-tighten the knob.
4. Repeat the procedure on the opposite side.

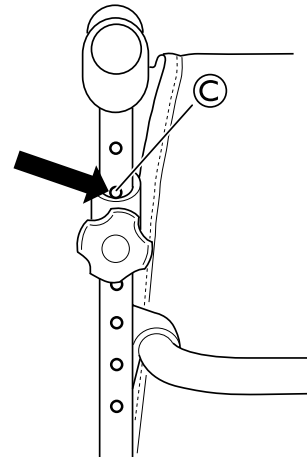

i In order to lock the position of the push handle, the nearest upper hole (C) should be visible, just as shown on the picture above.



WARNING!
Risk of pinching

- Be careful not to get pinched when reclining the backrest. Never hold your fingers or any other body parts in the marked area (B).

3.10 Armrests



WARNING!
Risk of injury

- The side rests are not locked and can be easily pulled out upwards.
- Do not lift or transfer the wheelchair using the side rests.
 - Do not use the side rests for transportation when carrying the wheelchair up- or downstairs.



CAUTION!
Risk of pinching

- Keep your fingers away from movable parts during removing, fitting or adjusting the armrest.

3.10.1 Flip-up armrests

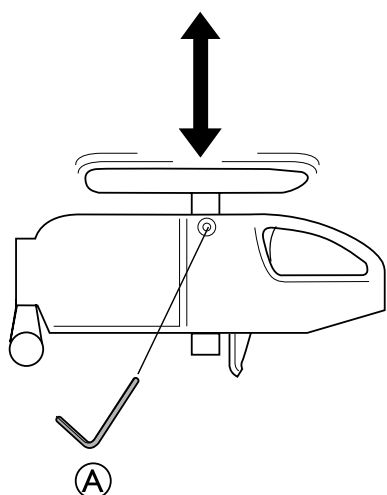

1. Loosen the screw (A).
2. Adjust the armrest height to the required position.
3. Re-tighten the screw.
4. Repeat the procedure on the opposite side.

 5 mm allen key

1. Loosen the screw or the handwheel (B), depending on which type of armrest you have chosen.
2. Adjust the armrest height to the required position.
3. Re-tighten the screw / handwheel.
4. Repeat the procedure on the opposite side.

 5 mm allen key

Depth adjustment:

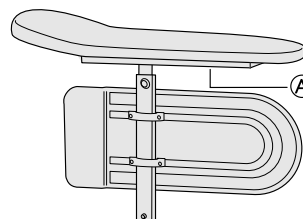

1. Loosen the screw or the handwheel (A), depending on which type of armrest you have chosen.
2. Adjust the armrest height to the required position.
3. Re-tighten the screw / handwheel.
4. Repeat the procedure on the opposite side.

 5 mm allen key

3.10.2 Detachable armrests

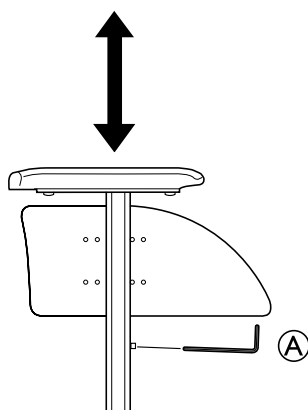

1. Loosen the screw (A).
2. Adjust the armrest height to the required position.
3. Re-tighten the screw.
4. Repeat the procedure on the opposite side.

 Tools: 5 mm Allen key

3.10.3 Height adjustable armrests

Height adjustment:

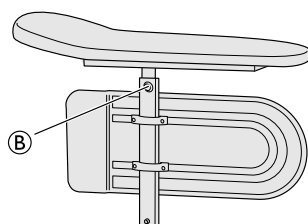

3.11 Adjusting the seat depth



WARNING!

Risk of tipping

- When the seat depth is adjusted backwards, also adjust the rear wheels backwards to decrease the risk of tipping.

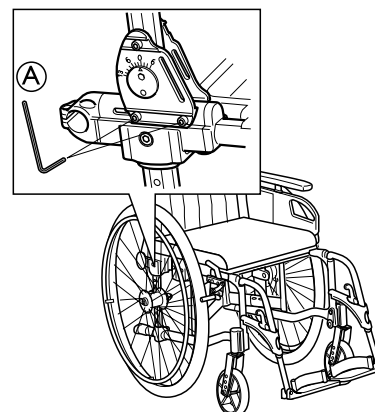

1. Remove the armrests.
2. Loosen the two screws (A).
3. Adjust to the desired seat depth.
4. Re-tighten the screws.
5. Repeat the procedure on the opposite side.

 5 mm allen key

3.12 Adjusting the seat width



The seat width can be increased by 25 mm.

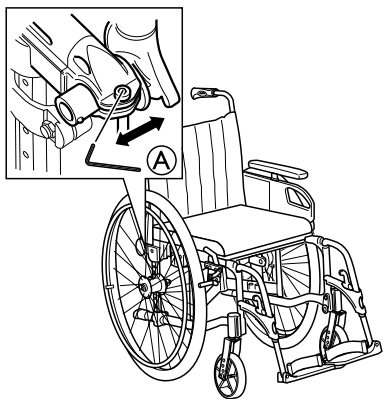

1. Remove the armrests and the seat cushion.
2. Loosen the two screws **A**.
3. Adjust the seat width.
4. Re-tighten the screws.

If the wheelchair is equipped with Flip-up armrests, the following also needs to be done:

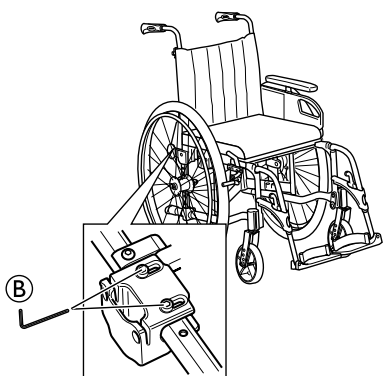



1. Loosen the screws **B**.
2. Re-tighten both screws **A** and the screws **B**

 5 mm allen key

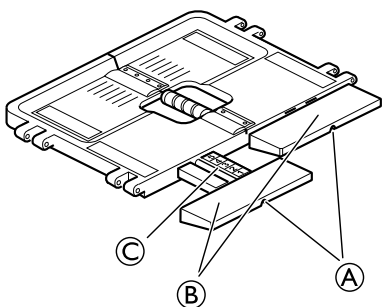
3.13 Adjusting the seat





1. Loosen the screw **A**.
2. Adjust the seat front **B** to the desired position.
 -  Only adjust the seat front within the marked area **C**. Max adjustment 5 cm
3. Re-tighten the screws again.
4. Repeat the procedure on the opposite side if necessary.

 The seat front **B** can also be removed completely if necessary.

 Screwdriver

3.14 Leg rests

 **WARNING!**
Risk of injury
 – Never lift the wheelchair by the footrest supports or leg rests.

 **CAUTION!**
Risk of pinching or crushing fingers
 There are swing mechanisms where you could trap your fingers.
 – Be careful when using, swinging, disassembling or adjusting these mechanisms.

 **NOTICE!**
Risk of damage to the leg rest mechanism
 – Do not place anything heavy, or let children sit on the leg rest.

3.14.1 Swing away leg rests

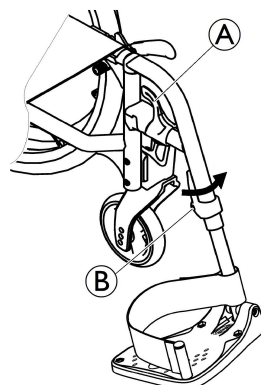

Swinging outwards

1. Activate the release lever **A** and swing the leg rests to the outside.

Swinging forwards

1. Swing the leg rest forwards until it engages.

Unhinging

1. Activate the release lever **A**.
2. Pull the leg rest upwards.

Hinging

1. Hinge the leg rest on the front of the frame and swing it forwards until it engages.

3.14.2 Swing Away, Angle Adjustable Leg Rests

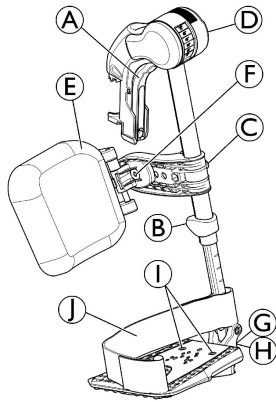

Swinging outwards

1. Activate the release lever **A** and swing the leg rests outwards.

Swinging forwards

1. Swing the leg rest forwards until it engages.

Unhinging

1. Activate the release lever **A**, swing the leg rest outwards.
2. Pull the leg rest upwards.

Hinging

1. Push the leg rest down into its receiver and swing it forwards until it engages.

Adjusting angle

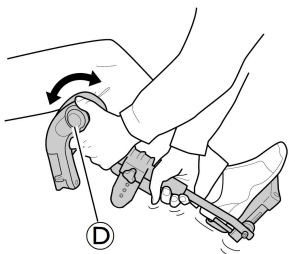

There are six preset positions available for angle adjustment.

1. Rotate the knob **D** with one hand while supporting the leg rest with your other hand.
2. When a suitable angle is obtained, let go off the knob and the leg rest will lock into the desired position.

Swinging calf pad and adjustments

- Swinging calf pad forwards (1) or backwards (2):

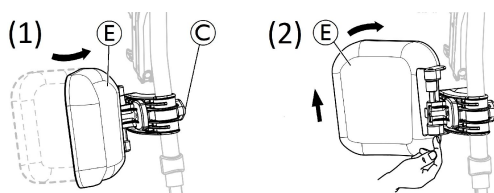

1. Swing calf pad **E** forwards (1).
2. Pull up the calf pad **E** and swing it backwards (2).

- Locking the calf pad swing backwards:

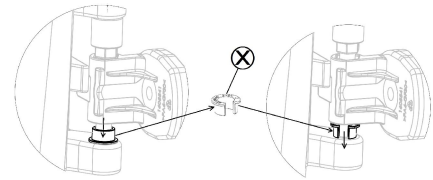

1. Extract the grey spacer open ring **X** out of its location.
2. Reverse the grey spacer open ring.
3. Insert the grey spacer open ring **X** as shown on the right side of the diagram.

-  Reverse this procedure to unlocking the calf pad swing backwards.

- Adjusting height of calf pad:

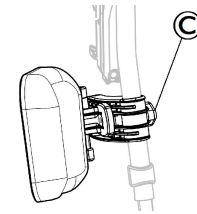

1. Loosen knob **C**.
2. Adjust to the desired height and firmly tighten the knob.

- Adjusting depth of calf pad

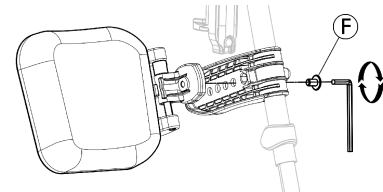

The calf pad has four depth adjustment options:

1. Remove the fixing screw **F** with 5 mm Allen key.
2. Adjust to one of the four positions and firmly tighten the fixing screw **F** (3–5 Nm).

Adjusting foot plate

There are three different fold-up foot plates available.

- Standard height-adjustable foot plates:

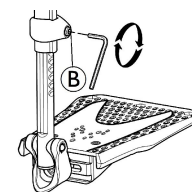

1. Loose the fixing screw **B** with 5 mm Allen key.
2. Adjust the height and let the screw catch one of the recesses on the foot plate tube.
3. Tighten the fixing screw **B** (3–5 Nm) in the desired position.

-  The distance between the lowest part of the footrest and the ground must be at least 50 mm.

- Depth-, Angle- (1) and Width- (2) adjustable foot plates:

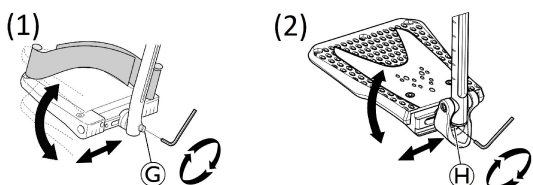

1. Loosen the fixing screw G or H with 5 mm Allen key.
2. Adjust the depth and angle positions and firmly tighten the fixing screw G (12 Nm) or H (8–9 Nm) in the desired position.

- Width-adjustable foot plates (2):

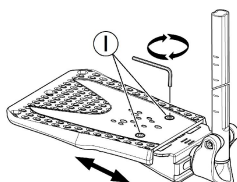

1. Loosen the two fixing screws I with 5 mm Allen key.
2. Adjust the width position and firmly tighten the two fixing screws I (3–5 Nm) in the desired position.

Invacare recommends that foot plate adjustment is carried out by a qualified technician.

i To ensure a good position of the feet, two types of straps can be provided; the heel strap (serial) and the calf strap (optional) attached to the leg rest support. Both adjustable by hook and loop fasteners or sliding buckle.

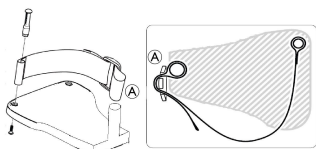

The plastic buckle must be fitted facing outwards and as close as possible to the tube of the footplate A.

3.14.3 Adjusting the amputee legrest



WARNING!
Risk of tipping

There is an increased risk of tipping for amputated users.

- Use anti-tip devices and/or re-balance the wheelchair by moving the rearwheels backwards when amputee legrests are used. Use the passive or the dual amputee rearwheel attachment.

See section “Adjusting the rearwheels” for more information.

Adjusting the height, depth and angle

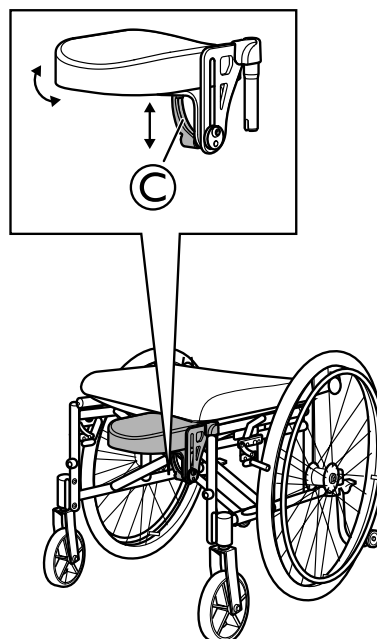

1. Loosen the lever C.
2. Adjust to the required height, depth and or angle.
3. Re-tighten the lever.

3.14.4 Adjusting the one-piece footrest



WARNING!
Risk of trapping fingers

The fingers might get trapped between the foot plate and the foot plate attachment.
– Be careful not to trap your fingers between the foot plate and the foot plate attachment when folding it down.

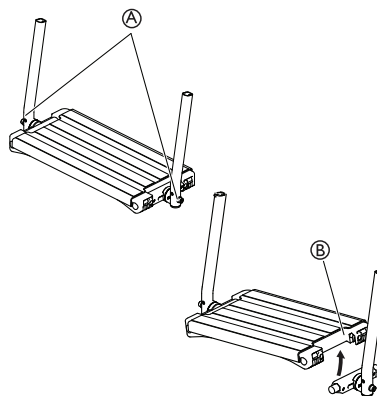

1. Adjust the angle and the depth by loosening the two screws A at the foot plate attachment.

i Tool: 5 mm allen key

2. Adjust the foot plate to the correct position.
3. Re-tighten the screws with 10 Nm.

i The foot plate can be flipped up. Lift the foot plate B upwards as shown on the picture above.

i Do not place anything on the foot plate when the screws are loose.

3.15 Seat cushion

A suitable cushion is recommended to provide an even pressure distribution on the seat.

**CAUTION!****Risk of instability**

Adding a cushion to the seat will raise your height above the ground and can affect your stability in all directions. If a cushion is changed it may also change the user's stability.

- If the thickness of the cushion is changed, a complete set up of the wheelchair need to be done by a qualified technician.
- We recommend using an Invacare or Matrx cushion with anti-slip base cover in order to prevent sliding.

4 Options

4.1 Inlay cushion seat

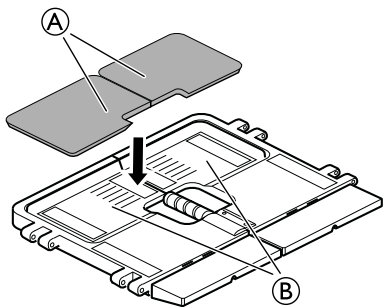

1. To obtain a flat seat, place the inlay cushion (A) on the seat plate.
2. Fit the inlay cushion at the back of the seat plate (B).

4.2 Trunk support Swing away

Height adjustment:

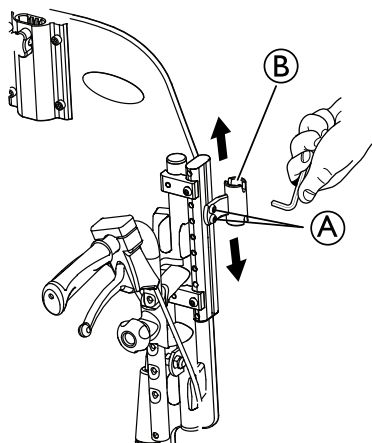

1. Loosen the screws (A).
2. Slide the trunk support holder (B) up or down to the desired position.
3. Re-tighten the screws.

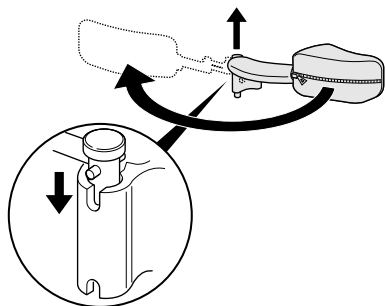

i The "swing-away" trunk support can be turned sideways in order to be out of the way when the user is moving in to or out of the wheelchair.

! **CAUTION!**
Risk of pinching

– The cover on the trunk support arm must always be on when the chair is in use.

Angle adjustment:

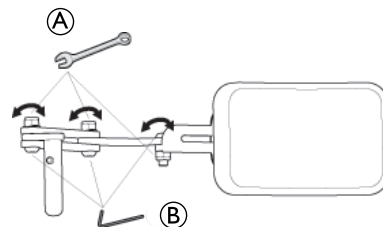

1. The angle can be adjusted by loosening the screws (B) and bolts (A) on the trunk support arm.
2. Hold with the allen key and tighten with the fixed spanner.
3. Remember to re-tighten the screws and bolts when the required position is achieved.

! 5 mm allen key / 13 mm fixed spanner.

Depth adjustment:

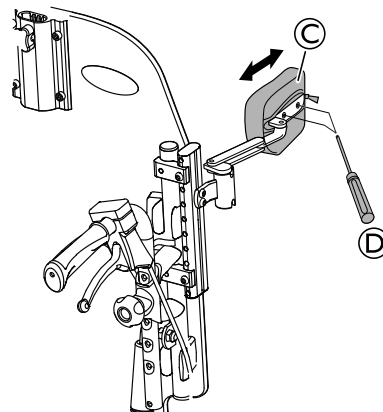

1. Open the zip on the cover (C).
2. Loosen the screws (D).
3. Adjust the trunk support to the desired depth.
4. Re-tighten the screws (C).
5. Close the zip on the cover.

! Screwdriver



CAUTION!
Risk of pinching

– Be careful not to pinch your fingers between the trunk support and the wheel when propelling the chair.

4.3 Trunk support fixed arm

Height adjustment:

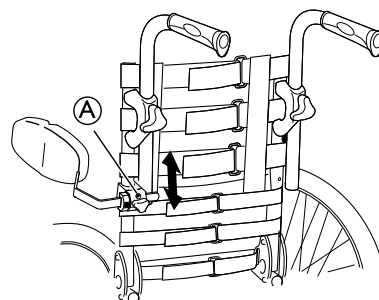

1. Loosen the screw (A).
2. Adjust the attachment upwards or downwards to the desired height.
3. Re-tighten the screw (A).



Screwdriver

**CAUTION!****Risk of pinching**

– Be careful not to pinch your fingers between the trunk support and the wheel when propelling the chair..

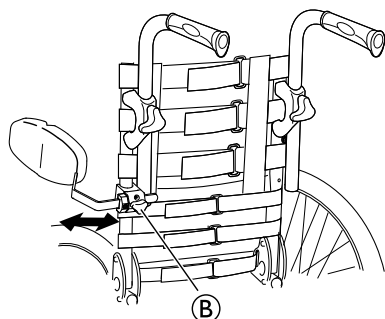
Depth adjustment:

1. Loosen the handwheel (B).
2. Adjust the depth of the trunk support.
3. Re-tighten the handwheel.

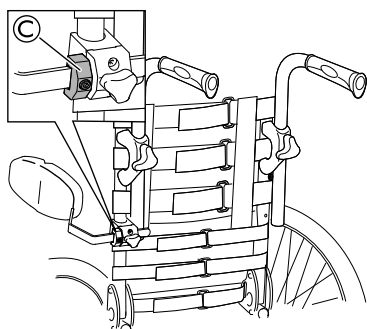
Memory function depth adjustment:

1. Add the memory block (C) on the trunk support.
2. Mount the trunk support in the attachment.
3. Adjust the trunk support to the desired depth and fixate the depth.
4. Place the memory block (C) in front of the attachment.
5. Tighten the screw on the memory block.

i The memory function is a help to keep the depth settings when the trunk support is removed from the wheelchair.

4.4 Headrest / Neckrest**WARNING!****Imbalance of the chair**

– If the headrest or neckrest is mounted behind the backrest, it may affect the balance of the wheelchair. Control the balance of the wheelchair and if necessary, adjust the rearwheels backwards to increase the stability.

4.4.1 Biangular backrest

i The biangular backrest can be equipped with either headrest or neckrest. The headrest or neckrest is mounted on the push bar.

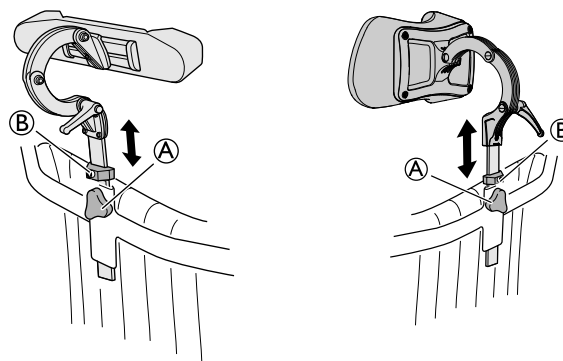
Height adjustment

i The height and the removal are operated by the handwheel. The bar is equipped with an adjustable stop block.

1. Loosen the screw in the stop block (B).
2. Loosen the handwheel (A).
3. Adjust the headrest or neckrest to the desired position.
4. Re-tighten the handwheel (A).
5. Slide the stop block (B) down to the top of the headrest/neckrest attachment.
6. Re-tighten the screw.

i 5 mm Allen key

i It is now possible to remove the headrest/neckrest and reinsert it in the desired position without further adjustments.

i For information about depth and angle adjustment of the headrest/neckrest and for repositioning of the headrest/neckrest, see following sections.

4.4.2 Reclining backrest

i The reclining backrest can be equipped with either headrest or neckrest. The headrest or neckrest is mounted in the attachment on the backrest.

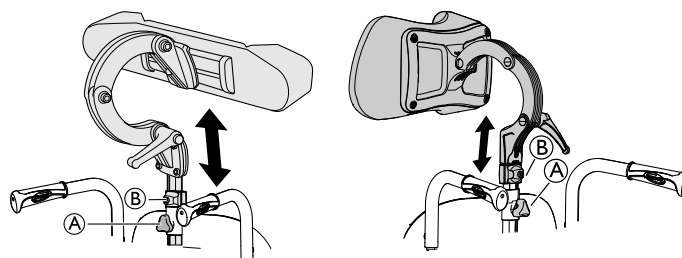
Height adjustment

i The height and the removal are operated by the handwheel. The bar is equipped with an adjustable stop block.

1. Loosen the screw in the stop block (B).
2. Loosen the handwheel (A).
3. Adjust the head rest to the desired position.
4. Re-tighten the handwheel (A).
5. Slide the stop block (B) down to the top of the headrest attachment.
6. Re-tighten the screw.

-  It is now possible to remove the headrest and reinsert it in the desired position without further adjustments.

Adjusting the rear wheels

WARNING! Safety risk

- When you have fitted the wheels in the correct position, make sure that the nuts and screws are tightened securely with a torque of 40Nm. This is important for your own safety.

WARNING! Safety risk

- Always remember to adjust the brakes, when the rear wheel position has been changed.

CAUTION! Damage to the product

- When adjusting the position of the rear wheel, the attachment clamps might be tightened unevenly and cause the rear wheels to come in contact with the armrests.
- Re-tighten the attachment screws alternately in order to get the clamps even.

Height adjustment

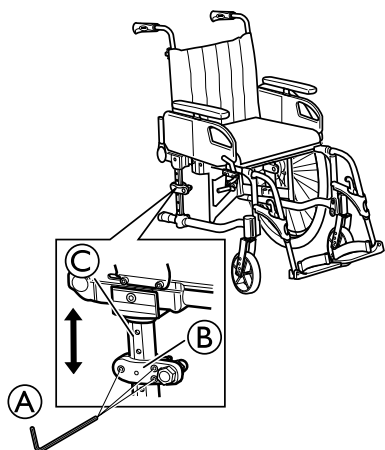

1. Loosen the screw (A).
2. Slide the clamp (B) up or down to the desired position.
 -  A peg on the inside of the clamp fits in the holes of the bar (C).
3. Re-tighten the screws.

 5 mm allen key

CAUTION! Damage to the product

- The clamps (B) might be tightened unevenly and cause the rear wheels to scratch against the armrests.
- Re-tighten the screws alternately in order to get the clamps even and to prevent the wheels from slanting.

Depth adjustment



WARNING! Risk of tipping

- Do not position the rear wheels in front of the backrest, this will increase the tip risk severely.

-  The rear wheel bar can be positioned in four different locations in order to change the wheel balance. In addition, the rear wheel can also be placed in front of the rear wheel bar, or behind the rear wheel bar.

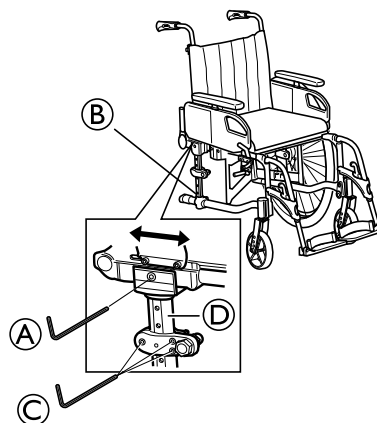
Front and rear position:





1. Loosen the screws (A) and (B).
 -  The screw heads should be visible before the rear wheel bar is moved.
2. Push or pull the rear wheel bar (D) to the most front or the most rear position.
3. Re-tighten the upper screw (A) first and then the lower screw (B).
 -  The upper screw (A) will only lock securely when it is fully inserted.

 5 mm allen key

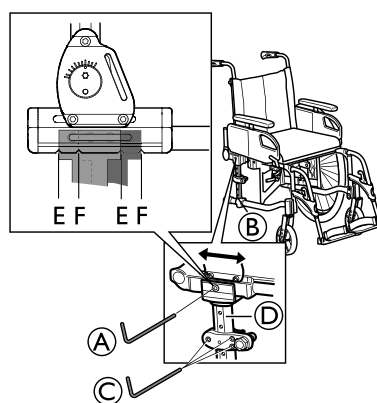
Middle positions:



1. Loosen the screws (A) and (B).
 -  The screw heads should be visible before the rear wheel bar is moved.
2. Push or pull the rear wheel bar (D) to the position between the markings (E) or (F) on the attachment.
3. Re-tighten the upper screw (A) first and then the lower screw (B).
 -  The upper screw (A) will only lock securely when it is fully inserted.

 5 mm allen key

Location of the rear wheel:

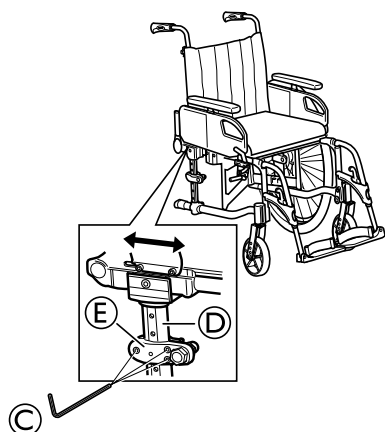

1. Loosen the screws **C**.
2. Turn the rear wheel clamps **E** around to position the rear wheel behind the rear wheel bar **D**.
3. Re-tighten the screws **C**.

 5 mm allen key

 If the rear wheels are positioned in front of the rear wheel bar **D**, the wheelchair will become more unstable. If the rear wheels are positioned further back, the stability will increase.

Camber

 Depending on the rear wheel attachment, this product can have 0 or 2 camber. To achieve 2 camber, the rear wheel attachment needs to be changed.

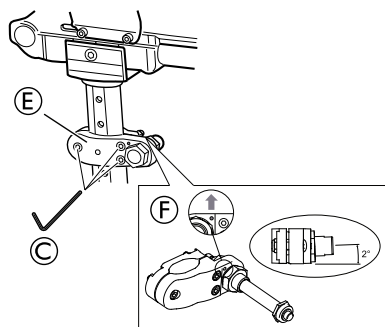

1. Loosen the screws **C**.
2. Remove the rear wheel attachment clamps **E**.
3. Mount the camber rear wheel attachment **F**.

 The 2 camber rear wheel attachment has a round marking on the outside of the clamp. Make sure that this marking is positioned upwards in order to obtain the correct angle.

4. Tighten the screws.

 5 mm allen key

Adjusting the castors



WARNING!

Risk of tipping

The castor might come off.

- Make sure to check that the castors are securely locked after each adjustment.



WARNING!

Safety risk

- Make sure that the castor housing is properly secured after each adjustment.

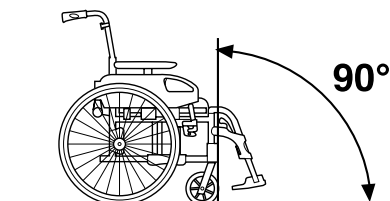

When you have found the desired seat height and depth, it's important to check that the angle between the castor attachment and surface is as close to 90° as possible, as it may affect the wheelchairs propelling ability.

Castor angle

1.

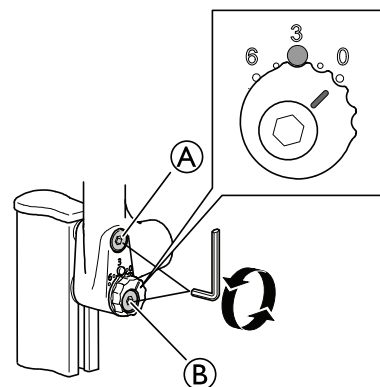

Loosen the screw **A**.

2. Loosen the screw **B** two turns.

3.

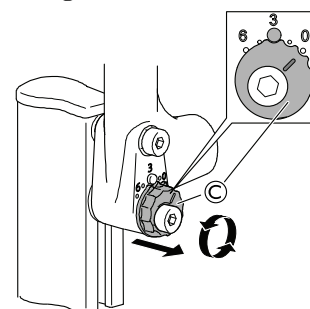

Pull out the adjustment screw **C**.

4.

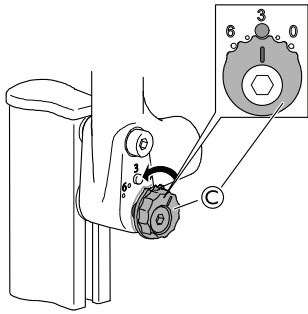

Turn the adjustment screw © to the desired angle position.

i The castor can be angled in 5 different positions from 0° to 6°.

5.

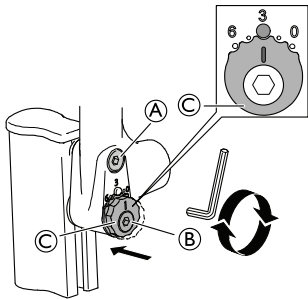

Push the adjustment screw © back into position after the adjustment.

6. Re-tighten the screws Ⓐ and Ⓑ.

i The screws should be tightened with a torque of 20 +/- 2 Nm.

i 5 mm allen key

Castor height

i Observe that only the height (89,4 mm) version of the castor attachment is adjustable in height.

1.

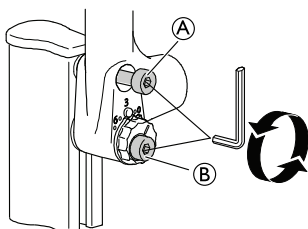

Loosen the screw Ⓐ with approximately 7 turns.

2. Loosen screw Ⓑ with approximately 2 turns.

3.

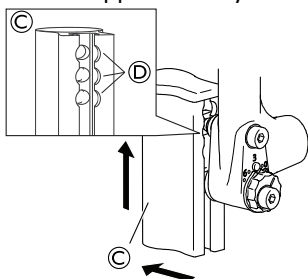

Pull out the castor housing © and adjust it to a desired height.

i There are three possible fixed heights Ⓓ.

4.

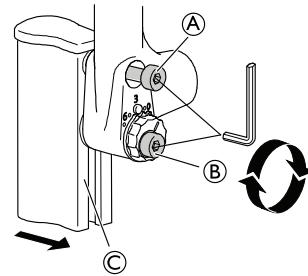

Push the castor housing © back into position after adjustment.

5. Re-tighten the screws Ⓐ and Ⓑ.

i The screws should be tightened with a torque of 20 +/- 2 Nm.

i 5 mm allen key

Adjusting the brakes



WARNING!

Reduced brake effect

– Incorrect adjustments of the brake can reduce the effectiveness of the brake.

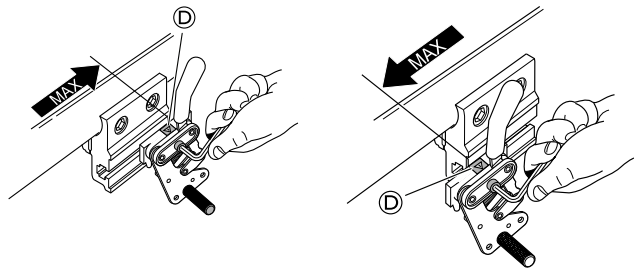

WARNING!

Risk of reduced brake effect

– The brakes must not be moved further forwards or backwards than indicated by the warning label Ⓓ.

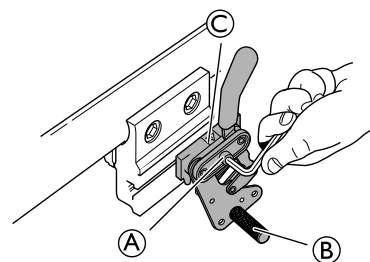

1. Check that the tires have the correct air pressure.

i You can find the information about the air pressure on the tire.

2. Loosen the screw Ⓐ.

3. Slide the brake © forward or backwards to the desired position.

4. Re-tighten the screw.

i The distance between the brake shaft Ⓑ and the tire should be approximately 15 mm.

If further adjustments of the brakes are necessary, the brake attachment can also be adjusted forwards or backwards:

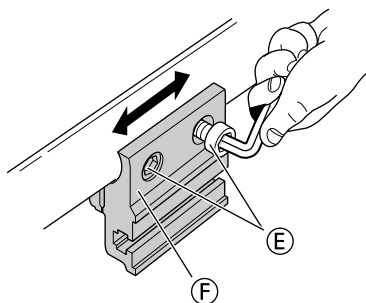

1. Loosen screws (E) on the brake attachment (F).
2. Slide the brake attachment (F) forward or backward to the desired position.
3. Re-tighten the screws.

 5 mm allen key

Depth / angle adjustment

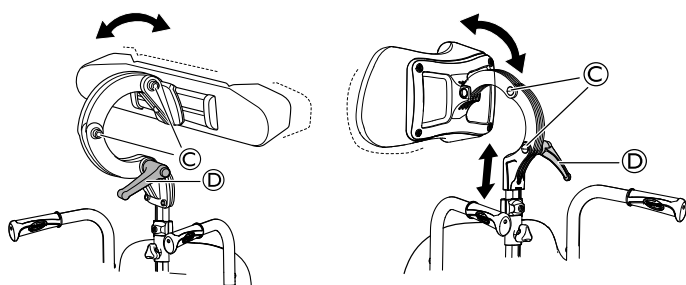

1. Loosen the handle (D).
2. Loosen the screws (C).
3. Adjust the depth and angle of the headrest.
4. Re-tighten the handle and the screws.

Positioning the headrest / neckrest to the front

 This additional depth adjustment will move the headrest another 7 cm forward.

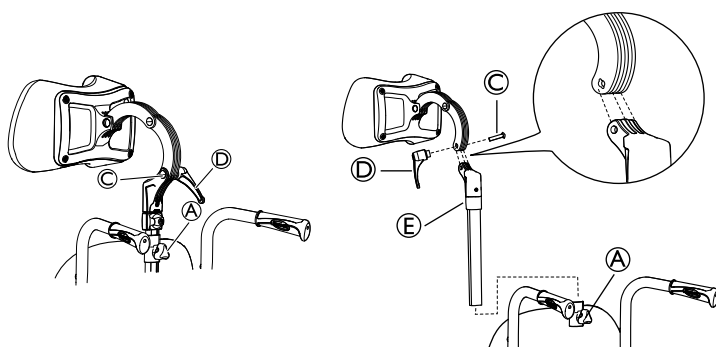

 You can also adjust the angle and depth by turning the attachment for the headrest / neckrest.

1. Loosen the handwheel (A).
2. Remove the headrest / neckrest.
3. Loosen the handle (D).
4. Remove the screw and the handle.

5. Rotate the headrest / neckrest attachment pole including the attachment (E).
6. Return the headrest / neckrest to the attachment.

 Note that the screw to the headrest / neckrest attachment (C) and the handle (D) must be mounted on the opposite side due to the groves in the screw hole.

7. Return the headrest / neckrest to the attachment on the backrest.
8. Re-tighten the handle (D) and the handwheel (A).

4.5 Tipper aid

With the tipper aid, an assistant can tip the wheelchair more easily, in order to navigate steps for example.



WARNING! Risk of overturning

– Ensure that the tipper aid does not project beyond the external diameter of the rear wheel.

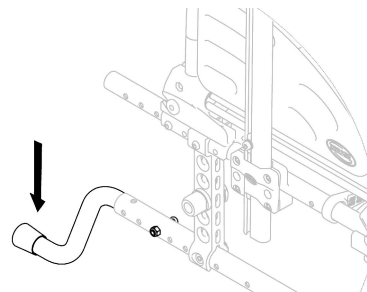

1. Hold the wheelchair by the push handles.
2. Press the tipper aid with your foot and hold the wheelchair in the tipped position until you have overcome the obstacle.

4.6 Table tray



WARNING! Risk of falling / injury

– The table must never be used as a replacement for the posture belt.



WARNING! Risk of tipping / injury

– Max load on the table: 8 kg



CAUTION! Risk of discomfort / minor bruises

– Make sure that the elbows of the user are placed on the table when pushing the wheelchair. If the elbows protrude from the table while pushing the wheelchair, there is a risk of discomfort or minor bruises.

The table tray can be adjusted both in depth and width, the following sections will show the different possibilities.

4.6.1 Mounting the attachment for table tray

1.

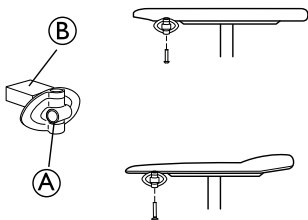

Mount the table attachment (A) with the attachment part facing outwards. The plain surface (B) of the attachment should be placed upwards when using the table on the thin armrests.

2.

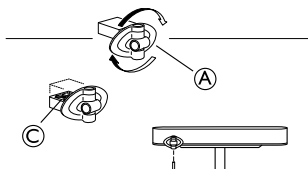

To fit the table attachment (A) to the wide armrest, turn the attachment around, the patterned surface (C) should now be facing upwards.

4.6.2 Adjusting the depth of the table tray

1.

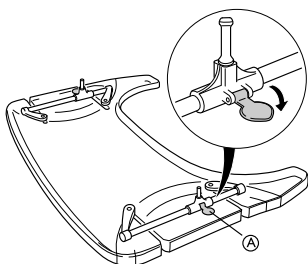

Open the safety lock for the depth adjustment (A).

2.

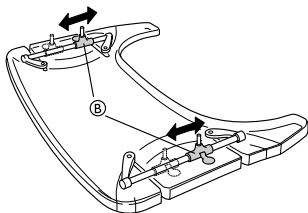

Adjust the table holders (B) forwards or backwards to adjust to the required depth.

3.

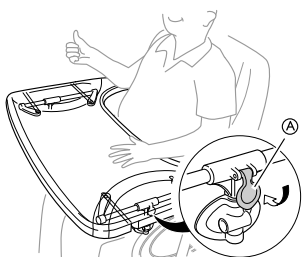

Close the table lock (A) again in order to lock the depth position.

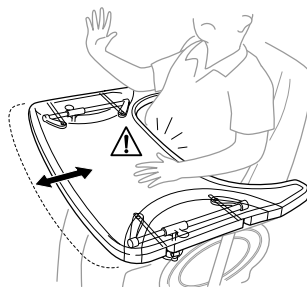

CAUTION! Risk of discomfort

– When adjusting the depth of the table, make sure not to squeeze the stomach of the user.

4.6.3 Locking the table tray



WARNING! Risk of injury

The user is locked in a fixed position and can not be removed from the wheelchair without unlocking the table.
– The use of locking device for table tray must be prescribed by authorized personnel.

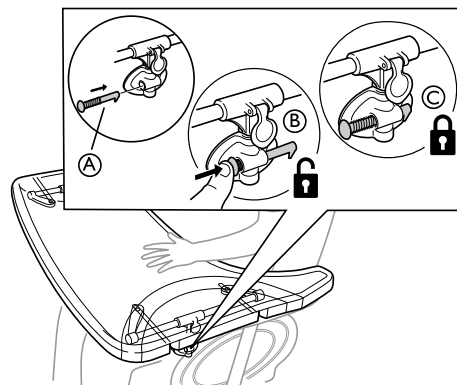

1. Place the locking pin (A) in the table attachment.
2. Press the locking pin (A) inwards to unlock the table (B).
 ⓘ Keep pressing the locking pin inwards in order to keep the table in an unlocked position .
3. Release the locking pin (A) to lock the position of the table (C).

4.7 Add a table tray cushion

A cushion for the table tray can be placed on the table tray in order to have a softer surface for the arms and elbows.

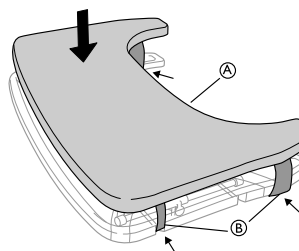

Place the cushion for the table tray (A) on the table and place the attachment straps (B) around the table.



CAUTION! Risk of discomfort / insecurity

The table is not in a fixed position.
– Make sure to engage the table lock again after adjusting the depth of the table.

4.8 Anti-tipper



WARNING!

Risk of overturning

Anti-tippers that are incorrectly set or no longer working can lead to overturning.

- Always check that the anti-tipper is working before using the wheelchair and have it set or readjusted by a qualified technician when required.
- In some configurations, the static stability of the wheelchair may be lower than 10°; Invacare strongly recommends the use of anti-tipper (available as an option).



WARNING!

Risk of overturning

On uneven or soft ground, the anti-tipper can sink into potholes or directly into the ground, thereby curtailing or eliminating its safety function.

- Only use the anti-tipper when travelling on even and firm ground.



NOTICE!

Risk of damage

- Never step on the anti-tipper or use it as a tipping aid.



WARNING!

Risk of tipping

An activated anti-tipper can catch when negotiating a step or an edge.

- Always deactivate the anti-tipper before driving over a step or kerb.



WARNING!

Risk of overturning

- Always advise the user if you deactivate the anti-tippers.



There is a red label on the housing of the anti-tipper, this label shows when the anti-tipper is inactivated. When the anti-tipper is correctly activated, the red label will be concealed.

4.8.1 Mounting anti-tip device swing-away

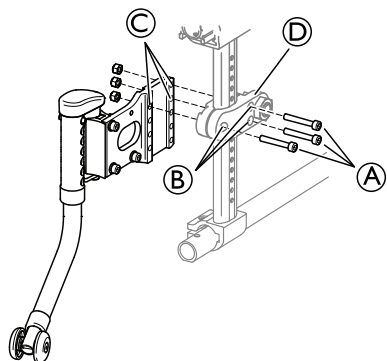

1. Insert the three screws (A) in the holes (B) of the rearwheel attachment (D).
2. Fit the screws in the holes on the anti-tip device attachment (C).



The anti-tip device can be mounted in different height positions, depending on the placement of the screws.

3. Tighten the screws firmly.



The distance between the wheel of the anti-tip device and the rearwheel should be approximately 50 mm.



5 mm allen key / 10 mm fixed spanner

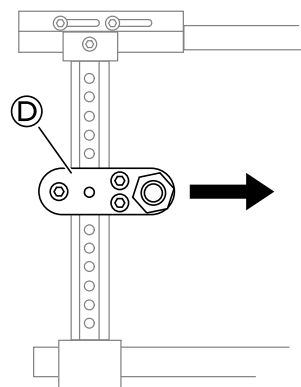

The rearwheel attachment (D) must be fitted facing forwards in order for the anti-tip device to function properly.

4.8.2 Anti-tipper swing-away

Height adjustment / Folding:

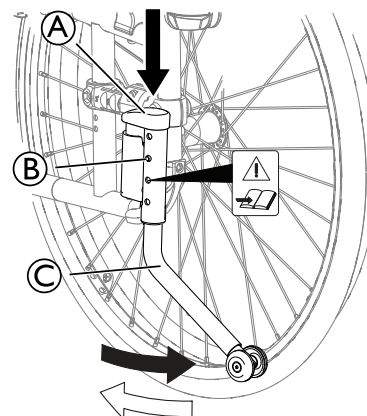

1. To adjust the height, press on the two knobs (B) placed on each side of the housing.
2. Adjust the anti-tipper tube (C) to the desired height.



Make sure that the anti-tipper is fitted correctly, the two knobs (B) must lock into position.

3. To fold the anti-tipper, press the top of the housing (A) downwards.

4. Push the anti-tipper sideways.

 Do not use the knobs **B** to fold or unfold the anti-tipper.





CAUTION!
Risk of pinching fingers

– Use the foot to fold the anti-tipper, otherwise there is a risk of pinching the fingers between the housing of the anti-tipper and the tube of the anti-tipper.

5. To activate the anti-tipper, push the anti-tipper back to its original place, it will automatically lock into position.

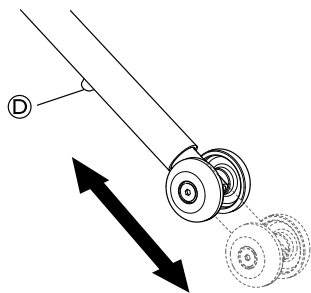
Depth adjustment:



1. Press on the knob **D**.
2. Adjust the inner wheel tube to the desired position.
 -  Make sure that the tube is fitted correctly on each side (if applicable), the knob **D** must lock into position.

 This adjustment is required with reference to the position and diameter of the rear wheel as well as the user conditions and his particular safety limits.



WARNING!
Risk of overturning

– The adjustments of the anti-tipper must be carried out by a qualified technician.

4.8.3 Anti-tip device regular

Mounting and depth adjustment:

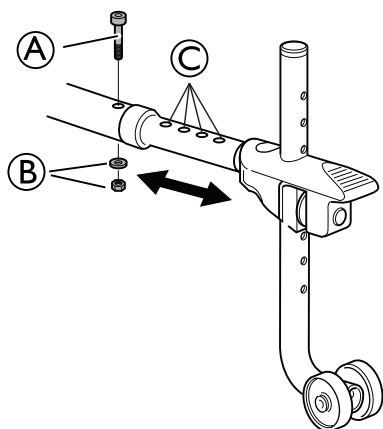

1. Exchange the plastic plugs on the tube of the chassis on both sides to the enclosed ones.
2. Mount the anti-tip device on the chassis tube.
3. Secure the anti-tip device with the screw **A** and the washer and nut **B**.
4. For depth adjustment, loosen the screw **A** and the nut **B**.

5. Adjust the depth and fit the screw **A** in one of the holes **C**.

6. Re-tighten the screw.



5 mm allen key / 10 mm fixed spanner

Height adjustment:

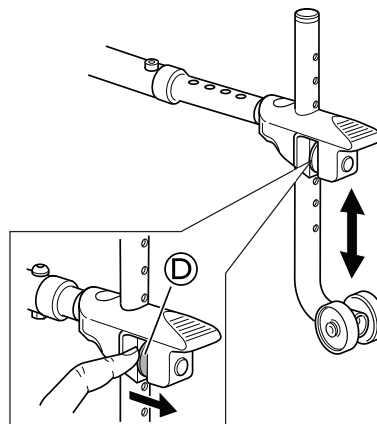

1. Release the spring loaded button **D**.
2. Adjust the anti-tip device to the required height.
3. Make sure that the anti-tip device locks into its new position.

4.9 Hemiplegic armrest

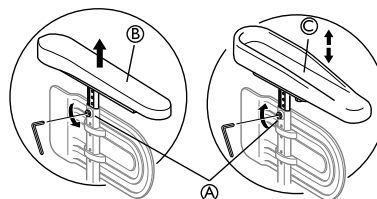

1. Loosen the screw **A**.
2. Remove the original armrest **B**.
3. Mount the hemiplegic armrest **C** in the armrest pole.
4. Re-tighten the screw **A**.

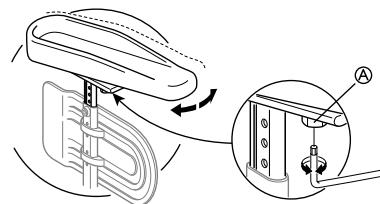

5. The hemiplegic armrest can be adjusted in angle. The resistance can be increased/decreased by adjusting the screw **A**.

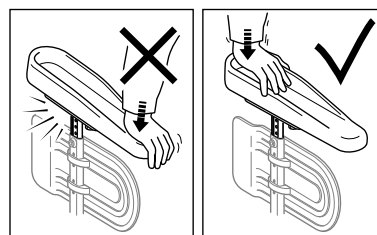

WARNING!
Risk of damage

Damage on the armrest
– Do not put pressure on the front of the armrest, as this could cause damage on the armrest attachment.

4.10 Lateral positioning pads (for adjustable backrest cover only)



WARNING!

Risk of trapping

- Be careful not to trap your trunk between the two lateral positioning pads during front or lateral transfers; when the user is moving in the wheelchair.



CAUTION!

Risk of uncomfortable posture

- Insufficient space between the lateral positioning pads can be uncomfortable for certain users.
- This adjustment must be performed by a qualified technician upon agreement by a prescribing physician.
 - Consult with your provider.



The lateral positioning pads can be adjusted in height and sideways.

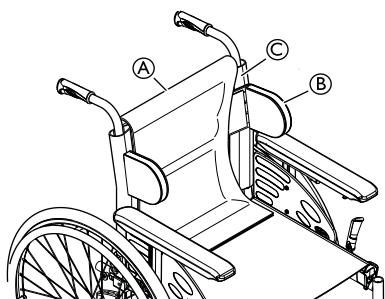

1. Remove the backrest cushion (A).
2. Adjust the lateral positioning pads (B) in height and sideways to the required position with the hook surface of the backrest cover (C).
3. Ensure that the two hook surfaces (pads and back cover) are set correctly.
4. Put the backrest cushion (A) back in place.

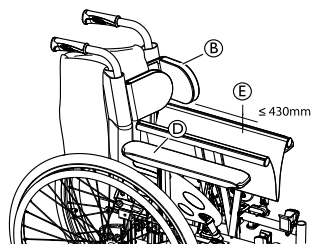

The lateral positioning pads (B) must be located above the arm pad (D) in order to be able to fold the wheelchair.



If the seat width is larger than 430 mm (E), the lateral positioning pads (B) must be removed before folding the wheelchair.

4.11 Posture belt

The wheelchair can be equipped with a posture belt. It prevents the user from sliding downward in the wheelchair or from falling out of the wheelchair. The posture belt is not a positioning device.



WARNING!

Risk of serious injury / strangulation

A loose belt can allow the user to slip down and create a risk of strangulation.

- The posture belt should be mounted by a qualified technician and fitted by the responsible prescriber.
- Always make sure that the posture belt is tightly fitted across the lower pelvis.
- Each time the posture belt is used, check if it fits properly. Changing the seat and/or backrest angle, the cushion and even your clothes influence the fit of the belt.

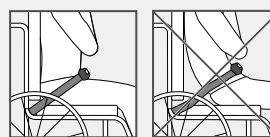

WARNING!

Risk of serious injury during transport

In a vehicle, a user in his wheelchair must be secured by a safety belt (3-point belt). A posture belt only is not sufficient as a personal restraint device.

- Use the posture belt as a complement, but not as a substitute to the 3-point safety belt, when transporting the wheelchair user in a vehicle.

Closing and opening the posture belt

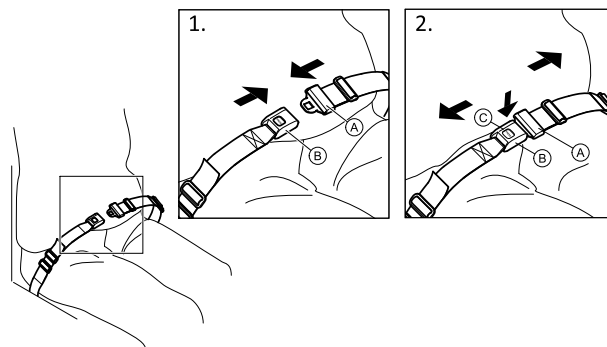

Ensure that you are sitting fully back in the seat and that the pelvis is as upright and symmetrical as possible.

1. To close, push the catch (A) into the buckle clasp (B).
2. To open, push the PRESS button (C) and pull the catch (A) out of the buckle clasp (B).

Adjusting the length



The posture belt has good length, when there's just sufficient space for a flat hand between body and belt.

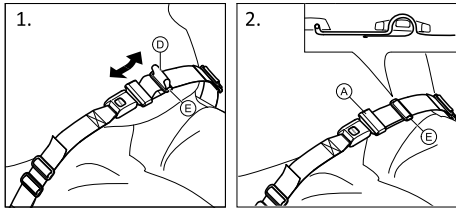

1. Shorten or extend the loop ① as required.
2. Thread loop ① through catch ② and plastic buckle ③ until the loop is flat.

If this adjustment is not sufficient, it might be required to re-fit the posture belt at the fixations.

Fitting the posture belt at the fixations



CAUTION!

- Thread the belt loop through both plastic buckles to avoid the belt from loosening.
- Do the adjustments on both sides equally, so that the buckle clasp remains in a central position.
- Make sure that the belts do not get caught in the spokes of a rear wheel.

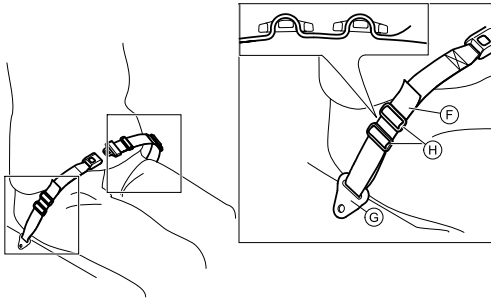

1. Thread the belt loop ④ through the fixation on the chair ⑤ and then through both plastic buckles ⑥.

4.11.1 Posture belt mounting

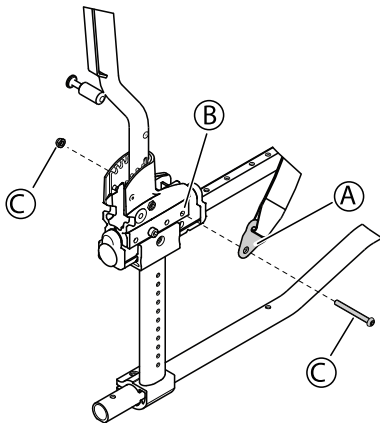

1. Fasten the posture belt ④ on the frame ⑤.
2. Attach the screw and the nut ⑥ and tighten.

4.12 Air pump

The air pump is fitted with a universal valve connection. Using the correct valve connection depends of the inner tube valve type.

1. Remove the dust cap from the valve connection.
2. Push the valve connection onto the open valve on the wheel and pump the wheel up.



There are two types of pumps available:

- Low pressure <6 bars
- High pressure >6 bars

Instruction for use printed on the packaging.

4.13 Passive illumination

You can attach reflectors to the rear wheels.

4.14 Cane holder

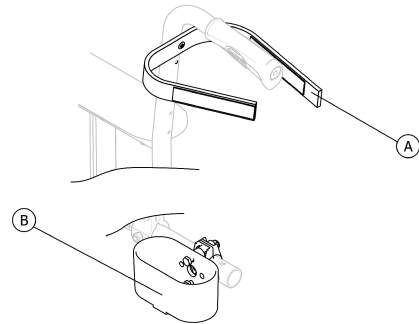

WARNING!

Risk of overturning

- Ensure that the cane holder does not project beyond the external diameter of the rear wheel.

1. Place the cane in the holder ⑦.
2. Fix the top of the cane to the backrest ⑧.

5 Setup

5.1 Safety information



CAUTION!
Risk of injury

- Before using the wheelchair, check its general condition and its main functions, 8.2 *Maintenance Schedule*, page 41.

Your authorized provider will supply your wheelchair ready for use. Your provider will explain the main functions and ensure that the wheelchair meets your needs and requirements.

Adjustments of the axle position and the castor supporters must be carried out by a qualified technician.

If you receive your wheelchair folded, read section 5.4 *Fitting the seat*, page 29.

5.2 Delivery check

Any transport damage must be reported immediately to the transport company. Remember to keep the packaging until the transport company has checked the goods and a settlement has been reached.

5.3 Fitting the rear wheels

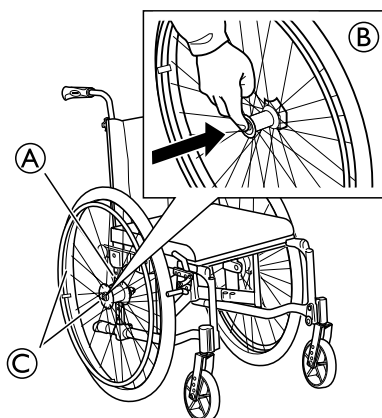

1. Press and hold in the quick—release button **B** in the center of the hub.
2. Put the rear wheel and the rear wheel axle **C** in the rear wheel attachment **A**.
3. Pull the wheels outwards to check that the wheel is securely locked in its position.



WARNING!
Risk of injury

- Check that the rear wheel is securely locked in its position! It should not be possible to remove the wheels when the quick-release button is inactivated.

5.4 Fitting the seat

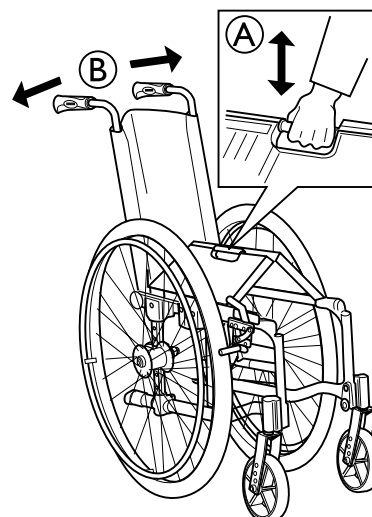

There are two ways to unfold the seat:

- Push the handle in the middle of the seat plate downwards **A**.
- Lift the rear wheel slightly upwards and push the push handles outwards **B**. When the seat plate is in the correct position, a “click” sound will be heard.



WARNING!
Risk of trapping fingers

- Be careful not to trap your fingers or hand when the seat plate is pushed in position.

5.5 Fitting the backrest bar

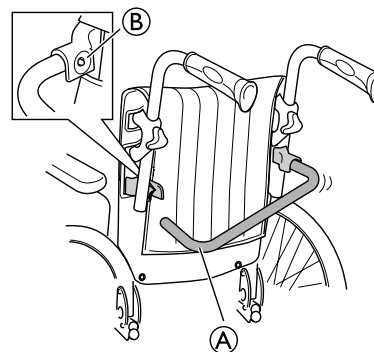

1. Fold up the backrest bar **A**.
2. Secure the backrest bar in the attachment with the quick-release knob **B**.



Make sure that the quick-release knob **B** is securely locked in its position.

5.6 Fitting the armrests

Flip—up armrests:

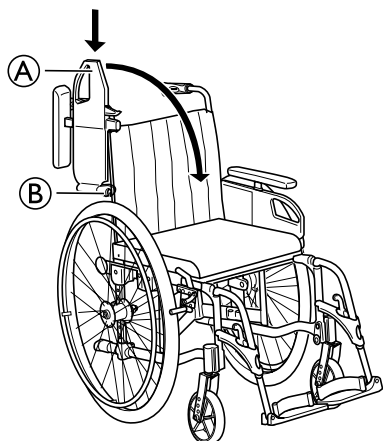

1. Insert the armrest (A) in the attachment (B) on the backrest frame.
2. Fold down the armrest (A) to fit it into the correct position.

Detachable armrests:

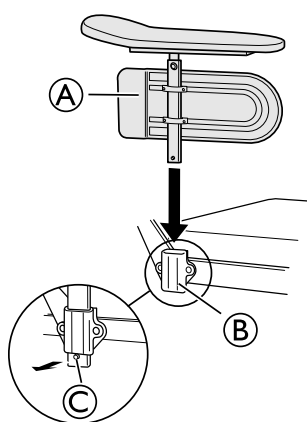

1. Place the armrest (A) in the armrest attachment (B).
2. Make sure that the quick-release button (C) is pressed outwards.



WARNING!

Risk of pinching fingers

– Do not place any fingers on the seat frame while pushing the armrests into the attachment.

5.7 Fitting the legrests



The brake lever handle will have a certain amount of free play. Without activating the brake, the lever will fold up automatically when the legrest has been moved to its outward position. To activate the brake just push the lever forwards.

5.7.1 Fixed leg rests

To install or remove the Swing away, Fixed leg rest, refer to → 3.14.1 *Swing away leg rests*, page 14.

5.7.2 Angle adjustable leg rests

To install or remove the Swing away, Angle adjustable leg rest, refer to → 3.14.2 *Swing Away, Angle Adjustable Leg Rests*, page 15.

6 Using the wheelchair

6.1 Safety information



WARNING!
Risk of accidents

Uneven tyre pressure can have a huge effect on handling.
– Check the tyre pressure before each journey.



WARNING!
Risk of falling out of the wheelchair

When using front wheels that are too small, the wheelchair could get stuck at curbs or in floor grooves.
– Make sure that the front wheels are suitable for the surface you're driving on.



CAUTION!
Risk of crushing

There may be a very small gap between the rear wheel and the mudguard or armpad with the risk that you could trap your fingers.
– Ensure that you always propel your wheelchair using the handrims only.



CAUTION!
Risk of crushing

There may be a very small gap between the rear wheel and the parking brake with the risk that you could trap your fingers.
– Ensure that you always propel your wheelchair using the handrims only.

6.2 Braking During Use

Whilst you are moving, you brake by transferring force to the handrim with your hands.



WARNING!
Risk of overturning

If you engage the parking brakes while you are moving, the direction of movement can become uncontrollable and the wheelchair may stop suddenly, which can lead to a collision or to you falling out.
– Never engage the parking brakes while you are moving.



WARNING!
Risk of falling out of the wheelchair

If the wheelchair is rapidly decelerated by an assistant pulling at the push handles, the user may fall out of the wheelchair.
– Always apply the posture belt if present.
– Make sure your assistant is qualified in transferring occupied wheelchairs.
– Operate the two brakes simultaneously and do not take slopes exceeding 7° to ensure perfect control of the wheelchair steering.
– Always use the parking brakes to secure the wheelchair during short or long stops.



CAUTION!
Risk of burning your hands

If you brake for a long time, a lot of frictional heat is produced at the handrims (especially anti slip handrims).
– Wear suitable gloves.

1. Hold the handrims and press evenly with both hands until the wheelchair stops.

User operated brake

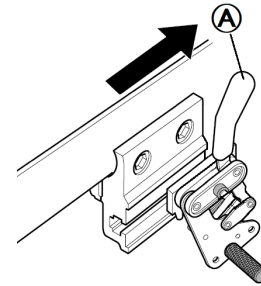

Start by checking that the tyres have the correct air pressure (printed on the side of each tyre).



The user brake is to be used when the chair is not moving, and is not intended for reducing speed when the chair is moving.

1. To engage the brake, move the lever Ⓐ towards the rear (towards you).
2. To disengage the brakes, move the lever Ⓐ forwards.



CAUTION!
Risk of trapping fingers

– Be careful not to trap your fingers between the brake shoe and rear wheel

Using the One Arm Brake

The wheelchair can be equipped with a one arm brake instead of the standard user operated brake. The one arm brake is operated in the same way as the standard user operated brake, the difference is that the brake handle brakes both wheels at the same time. The one arm brake is available both for the right and the left side of the wheelchair .

Assistant operated brake

1.

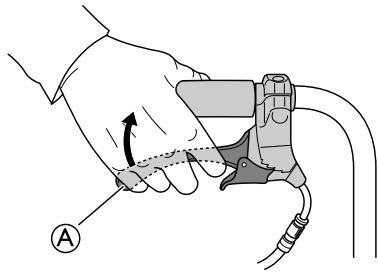

Pull both brake handles upwards to engage the brake.

2.

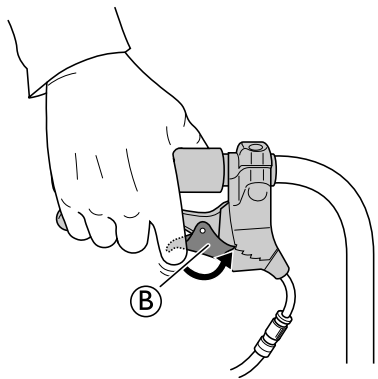

Pull the brake handle upwards and push the lock catch **B** downwards to lock the brake.

 Let go of the brake handle when the lock catch is fixated.

3.

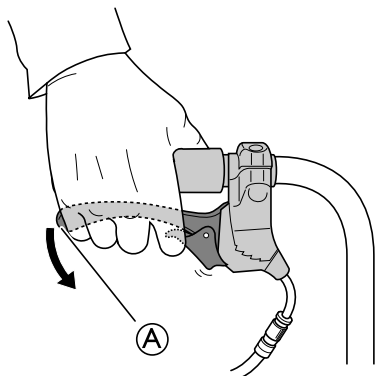

Move the brake handle **A** to release the lock catch.

 The lock catch will be released automatically when moving the brake handle

6.3 Move to/from the wheelchair



WARNING!

Risk of overturning

There is a high risk of overturning during the transfer.

- Only get in and out without assistance if you are physically able to do so.
- When transferring, position yourself as far back as possible in the seat. This will prevent damaged upholstery and the possibility of the wheelchair tipping forward.
- Make sure that both castors are facing straight to the front.



WARNING!

Risk of overturning

The wheelchair could tip forwards if you stand on the footrest.

- Never stand on the footrest when getting in and out.



CAUTION!

If you disengage or damage the brakes the wheelchair could roll away out of control.

- Do not support yourself on the brakes when getting in and out.



NOTICE!

The mudguards and armrests could become damaged.

- Never sit on the mudguards or armrests when getting in and out.



1. Propel the wheelchair as near as possible to the seat that you want to move to.
2. Engage the parking brakes.
3. Remove the armrests or move them upwards out of the way.
4. Detach the leg rests or swing them outwards.
5. Place your feet on the ground.
6. Hold the wheelchair and, if necessary, also hold a fixed object in the vicinity.
7. Move slowly to chair.

6.4 Driving and Steering the Wheelchair

You drive and steer the wheelchair using the handrims. Before driving without an assistant you must find your wheelchair's tipping point.



WARNING!

Risk of Tipping

The wheelchair can tip backwards.

- When finding the tipping point, an assistant must stand immediately behind the wheelchair to catch it if it tips over.
- To prevent tipping, install an antitipper device.



WARNING!

Risk of Tipping

The wheelchair can tip forward.

- When setting up your wheelchair, test its behavior in terms of tipping forward and adjust your driving style accordingly.

**CAUTION!**

A heavy load hanging on the backrest can affect the wheelchair's centre of gravity.
– Change your driving style accordingly.

Finding the Tipping Point

1. Release the brake.
2. Roll backwards a short distance, grasp both handrims firmly and push forwards with a slight kick.
3. The shift in weight and steering in opposite directions with the handrims will enable you to identify the tipping point.

6.5 Negotiating steps and kerbs**WARNING!****Risk of overturning**

When negotiating steps you could lose your balance and tip the wheelchair over.

- Always approach steps and kerbs slowly and carefully.
- Do not go up or down steps that are higher than 25 cm.

**CAUTION!**

An activated anti-tipper prevents the wheelchair from tipping backwards.

- Deactivate the anti-tipper before going up or down steps or kerbs.

**WARNING!****Risk of injury to the assistant and damage to the wheelchair**

Tilting the chair with a heavy user can hurt the assistant's back and damage the chair.

- Make sure to be able to safely control the wheelchair with a heavy user before performing a tilting maneuver.

Going down a step with an assistant

1. Move the wheelchair right up to the kerb and hold the handrims.
2. The assistant should hold both push handles, place one foot on the tipper aid (if installed) and tilt the wheelchair backwards so that the front wheels lift off the ground.
3. The assistant should then hold the wheelchair in this position, push it carefully down the step and then tilt it forwards until the front wheels are back on the ground.

Going up a step with an assistant



WARNING!

Risk of serious injuries

Going up steps and kerbs often than the normal use can cause a fatigue break of the wheelchair backrest and the user might fall out of the wheelchair.

- Make sure that the wheelchair can be controlled by the user or the assistant before performing a tilting maneuver.

1. Move the wheelchair backwards until the rear wheels touch the kerb.
2. The assistant should tilt the wheelchair using both push handles so that the front wheels lift off the ground, then pull the rear wheels over the kerb until the front wheels can be placed back on the ground.

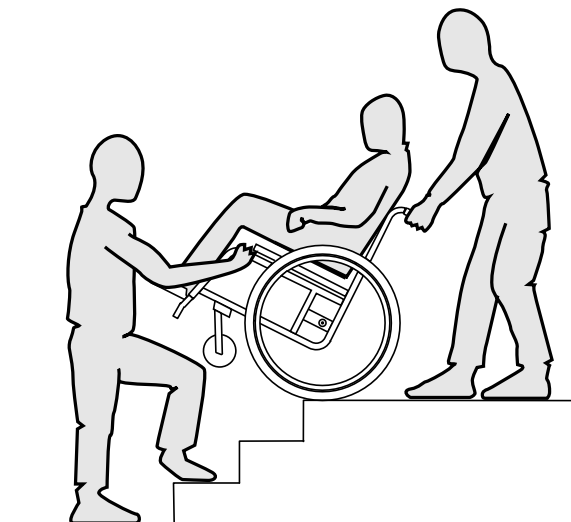

1. You can go up and down stairs by taking them one step at a time, as described above. The first assistant should stand behind the wheelchair holding the push handles. The second assistant should hold a solid part of the front frame to steady the wheelchair from the front.

Going down a step without an assistant

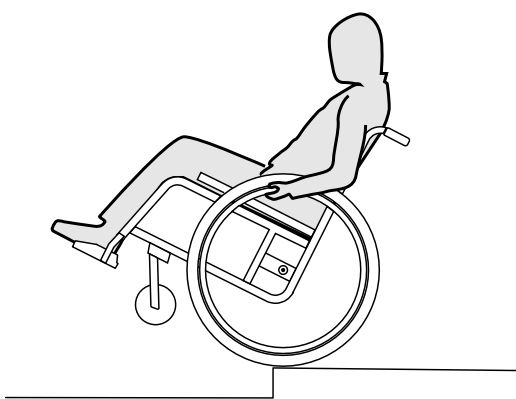

WARNING!

Risk of tipping

When going down a step without an assistant you could tip over if you cannot control your wheelchair.

- First learn how to go down a step with an assistant.
- Learn how finding the tipping point to balance on the rear wheels, *6.4 Driving and Steering the Wheelchair, page 32.*

1. Move the wheelchair right to the kerb, lift the front wheels and keep the wheelchair balanced.
2. Now slowly roll both rear wheels over the kerb. While doing this, hold the handrims firmly with both hands until the front wheels are back on the ground.

6.6 Going up and down stairs



WARNING!

Risk of overturning

When negotiating stairs you could lose your balance and overturn your wheelchair.

- Always use two assistants when negotiating stairs with more than one step.

6.7 Negotiating Ramps and Slopes



WARNING!

Risk due to wheelchair being out of control

When negotiating slopes or gradients your wheelchair could tip backwards, forwards or sideways.

- Always have an assistant behind the wheelchair when approaching long slopes.
- Avoid lateral slopes.
- Avoid slopes of more than 7°.
- Avoid jerking when changing direction on a slope.



CAUTION!

Your wheelchair could run away even on slightly sloping ground if you do not control it using the handrims.

- Use the parking brakes if your wheelchair is stationary on sloping ground.

Going up slopes

To go up a slope, you must create some momentum, keep up the momentum and control the direction at the same time.

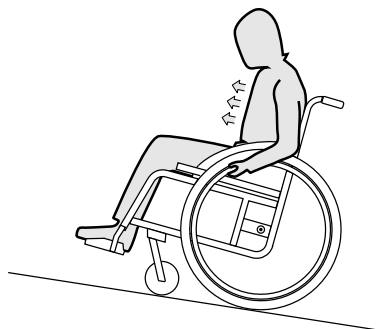

1. Bend your upper body forwards and propel the wheelchair with quick, powerful strokes on both handrims.

Going down slopes

When going down slopes, it is important to control your direction and particularly your speed.

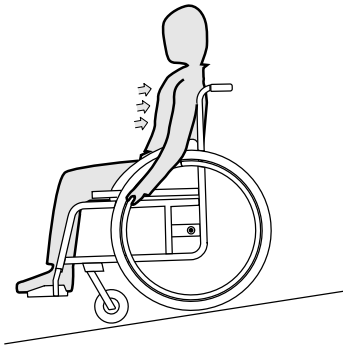

1. Lean back and carefully allow the handrims to run through your hands. You should be able to stop the wheelchair at any time by gripping the handrims.



CAUTION!

Risk of burning your hands.

If you brake for a long time, a lot of frictional heat is produced at the handrims (especially anti slip handrims).

- Wear suitable gloves.

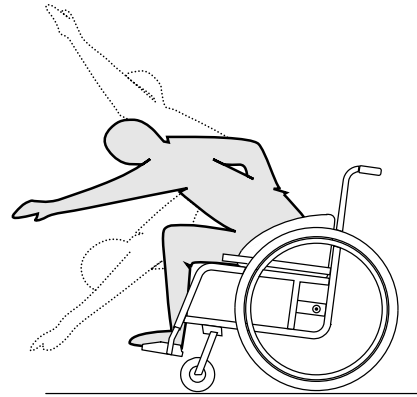

1. Point the front wheels forwards. (To do this, move your wheelchair forwards slightly then back again.)
2. Apply both parking brakes.
3. When leaning forwards your upper body must remain over the front wheels.

Reaching backwards



WARNING!

Risk of falling

If you lean too far backwards you could tip your wheelchair over.

- Do not lean out over the backrest.
- Use an antitipper device.

6.8 Stability and balance when seated

Some everyday activities and actions require you to lean forwards, sideways or backwards out of the wheelchair. This has a major effect on the wheelchair's stability. To keep your balance at all times, proceed as follows:

Leaning forwards



WARNING!

Risk of falling

If you lean forwards out of the wheelchair you could fall out of it.

- Never bend too far forwards and do not shift forwards in your seat to reach an object.
- Do not bend forwards between your knees to pick up something off the floor.

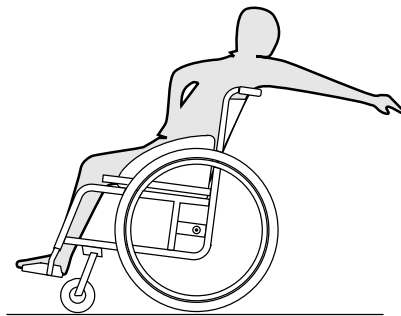

1. Point the front wheels forwards. (To do this, move your wheelchair forwards slightly then back again.)
2. Do not apply the parking brakes.
3. When reaching backwards do not reach so far that you have to change your sitting position.

7 Transport

7.1 Safety information



WARNING!

Risk of injury if the wheelchair is not properly secured

In the event of an accident, braking manoeuvre, etc. you may suffer serious injuries from flying wheelchair parts.

- Firmly secure all wheelchair components in the means of transport to prevent them from coming loose during the journey.

7.2 Folding the backrest bar

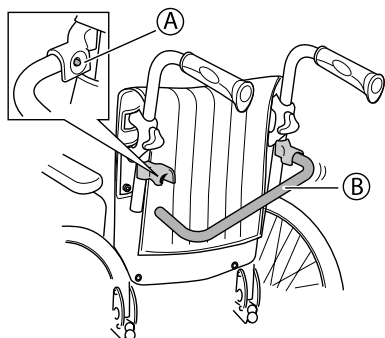

1. Release the spring button **A**.
2. Fold the backrest bar **B** downwards.

7.3 Removing the armrests

Flip-up armrests:

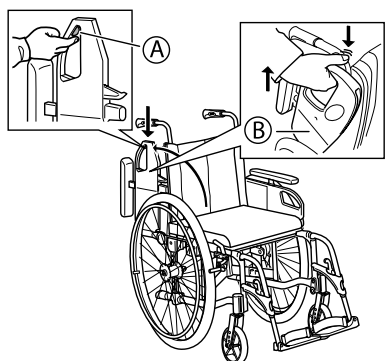

1. Press the button **A**.
2. Lift the armrest **B** straight up and remove it.
 - i** Lean the armrest slightly forward to make it easier to remove it.

Detachable armrests:

Lift the armrests straight up and remove them.

7.4 Folding the seat

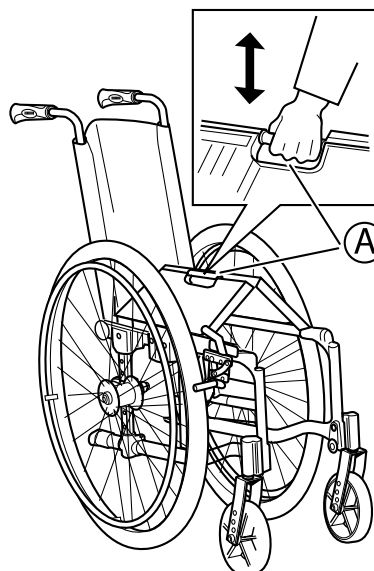

1. Pull the handle on the seat **A** straight up.
2. Fold the seat.



WARNING!

Risk of trapping fingers

- Be careful not to trap your fingers when folding the seat.

7.5 Fixed leg rests

To install or remove the Swing away, Fixed leg rest, refer to → 3.14.1 *Swing away leg rests*, page 14.

7.6 Angle adjustable leg rests

To install or remove the Swing away, Angle adjustable leg rest, refer to → 3.14.2 *Swing Away, Angle Adjustable Leg Rests*, page 15.

7.7 Brake lever



The brake lever handle will have a certain amount of free play. Without activating the brake, the lever will fold up automatically when the legrest has been moved to its outward position. To activate the brake just push the lever forwards.

7.8 Remove the rear wheels

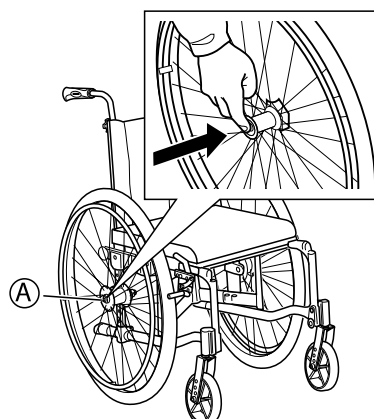

1. Press the quick release button .
2. Pull the rear wheel straight out.
3. Remove the rear wheel.
4. Repeat the procedure on the opposite side.

7.9 Lifting the wheelchair

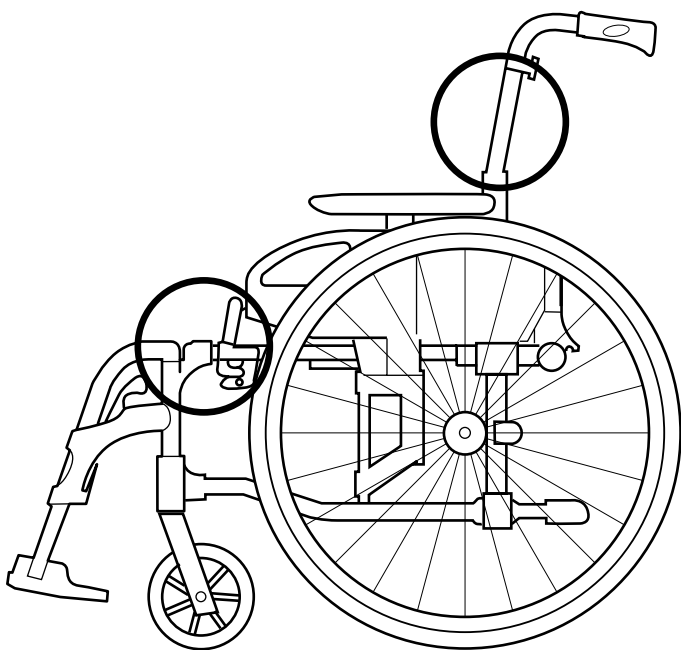

- Always lift the wheelchair by grabbing the frame at the points shown in the picture.
- Ensure that the backrest and push handles are securely in place.
- Read the chapter "Safety instructions/Propelling techniques."

 Never lift the wheelchair by using the backrest bar.

7.10 Transporting the Mobility Device without Occupant



WARNING!
Risk of injury if the wheelchair is not properly secured

In the event of an accident, braking manoeuvre, etc. you may suffer serious injuries from flying wheelchair parts.

- Firmly secure all wheelchair components in the means of transport to prevent them from coming loose during the journey.

 You can remove the rear wheels when transporting the wheelchair.



NOTICE!
Excessive wear and abrasion could affect the strength of load-bearing parts.

- Do not pull your wheelchair across abrasive surfaces without the wheels fitted (e.g. pulling the frame over tarmac).



CAUTION!
Risk of injury

- If you are unable to fasten your mobility device securely in a transport vehicle, Invacare recommends that you do not transport it.

Your mobility device may be transported without restrictions, whether by road, rail or by air. Individual transport companies have, however, guidelines which can possibly restrict or forbid certain transport procedures. Please ask the transport company regarding each individual case.

- Invacare strongly recommends securing the mobility device to the floor of the transporting vehicle.

7.11 Transporting the Occupied Wheelchair in a Vehicle

Even when the wheelchair is properly secured and the following rules are met, injuries to passengers may occur in a collision or sudden stop. Therefore Invacare strongly recommends transferring the wheelchair user to the vehicle seat. Do not make alterations or substitutions to points of the wheelchair (structure, frame or parts) without the written consent of Invacare Corporation. The wheelchair has been successfully tested according to the requirements of ISO 7176–19 (Frontal impact).



WARNING!
Risk of serious injury or death

To use the wheelchair as a seat in a vehicle the backrest height minimum must be at least 400 mm.

To transport the wheelchair with user in a vehicle, a restraint system must be installed in the vehicle. Wheelchair tie-downs and occupant restraint systems must be approved according to ISO 10542-1. Contact your local Invacare authorised provider for more information on getting and installing an approved and compatible restraint system.



WARNING!

If, for some reason, it is impossible to transfer the wheelchair user to a vehicle seat, the wheelchair can be used as a seat in a vehicle if the following procedures and regulations are followed. A transportation kit (optional) have to be fitted on the chair for such a purpose.

- The wheelchair must be secured in the vehicle with a 4-point wheelchair restraint system.
- The user must wear a 3-point passenger restraint system secured to the vehicle.
- The user must be additionally secured with a posture belt in the wheelchair.



WARNING!

Safety restraint devices must only be used when the wheelchair user's weight is 22 kg or more (ISO-7176-19).

- Do not use the wheelchair as a seat in a vehicle when the user weight is lower than 22 kg.

**WARNING!**

- Before journey contact transporter and request information about the capability for the below required equipment.
- Make sure there is sufficient free space around the wheelchair and user to avoid the user making contact with other vehicle occupants, unpadded parts of the vehicle, wheelchair options or anchor points of the restraint system.

**WARNING!**

- Make sure the tie-down points at the wheelchair are not damaged and that the parking brakes are fully functional.
- It's recommended to use puncture-proof tyres during transport to avoid brake problems due to reduced tyre pressure.

**WARNING!**

- Injury or damage may occur from wheelchair components or options loosened during a collision or sudden stop.
- Ensure all removable or detachable components and options are removed from the wheelchair and securely stored in the vehicle.
 - Disconnect the hand control (electrical version only) from its connection to the control box and securely stored in the vehicle.
 - It is essential to have your wheelchair checked by a qualified technician after an accident, collision etc.

Ramps and Slopes:**WARNING!****Risk of injury**

- The wheelchair can move forward / backward uncontrollably by mistake.
- Never leave the user unattended when transporting the wheelchair up or down ramps or slopes.



Therefore Invacare strongly recommends transferring the wheelchair user to the vehicle with the posture belt on.

**NOTICE!**

- Refer to the user manuals supplied with the restraint systems.
- The following illustrations may differ depending on the restraint system supplier.

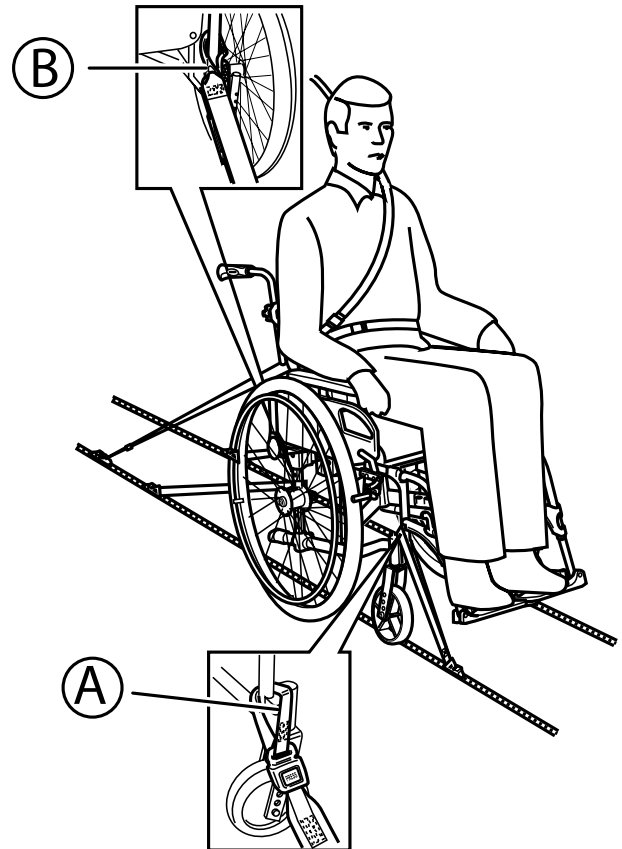

The choice of wheelchair configuration (seat width and depth, wheelbase) influences maneuverability and access to motor vehicles.

Securing the Wheelchair with a 4-point Restraint System:**WARNING!**

- Place the wheelchair with the user forward-facing in direction of vehicle travel.
- Engage the wheelchair parking brakes.
- Activate anti-tipper (if installed).

The wheelchair tie-down positions where the restraint system straps must be placed are marked with snap hook symbols (see following figures and section 2.3 *Labels and symbols on the product, page 6*).

1. Using the front and rear straps of the 4-point restraint system, secure the wheelchair to the vehicle mounted rails. Refer to the user manual supplied with 4-point restraint system.

Front side tie-down positions for snap hooks:



1. Attach the front straps above the castor supporters **A** as shown in the figure above (see location of the attachment labels).
2. Attach front straps to the rail system referring to best practice recommended instructions from the safety belt manufacturer.
3. Disengage parking brakes and apply tension front straps by pulling the wheelchair backwards from the rear.
4. Re-engage parking brakes.

Rear side tie-down positions for snap hooks:

1. Attach the snap hooks on the rear straps **B** to the frame just above the rear wheel attachments as shown in the figure above (see location of the attachment labels).
2. Attach rear straps to the rail system referring to best practice recommended instructions from the safety belt manufacturer.
3. Tighten the straps.

NOTICE!
 – Make sure that the snap hooks are covered with slip resistant material to avoid laterally slipping on the axle.

Fit posture belt

WARNING!
 The posture belt can be used in addition to but never as a substitute for an approved passenger restraint system (3-point belt).

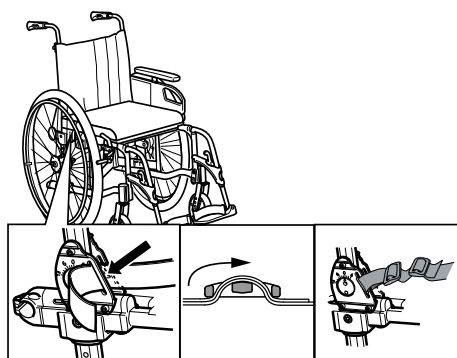

1. Adjust posture belt to fit the wheelchair occupant, see section *Posture belt*.

Fit neckrest (if installed)

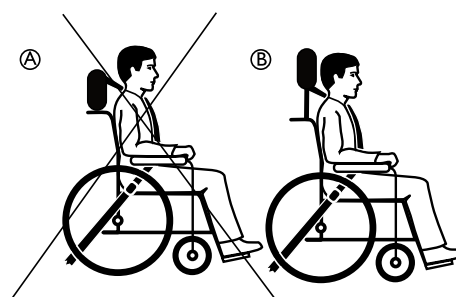

- A** Incorrect placement of the neckrest
- B** Correct placement of the neckrest

Fastening the 3-point Passenger Restraint System

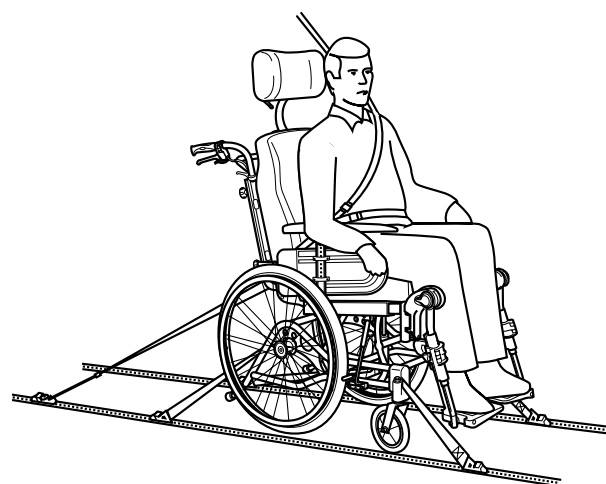

NOTICE!
 The illustration above may differ depending on the wheelchair and the restraint system supplier.

WARNING!

- Ensure the 3-point passenger restraint system fits as tightly across the user's body as possible without discomfort and no part is twisted.
- Ensure the 3-point passenger restraint system is not held away from the user's body by parts of the wheelchair such as armrests or wheels etc.
- Ensure the user restraint has a clear path from the user to the anchor point without interference by any part of the vehicle, wheelchair, seating or option.
- Ensure the lap belt fits snugly over the occupant's pelvis and is not allowed to ride up into the abdominal area.
- Ensure the user is able to reach the release mechanism unaided.

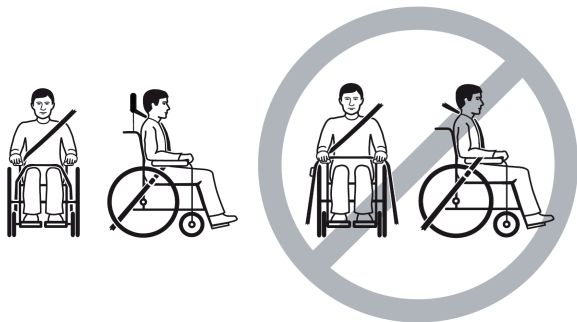

1. Attach the 3-point passenger restraint system referring to the user manual supplied with your 3-point restraint system.
2. The 3-point safety belt must not be held away from the user's body by parts of the wheelchair such as armrests or wheels etc.

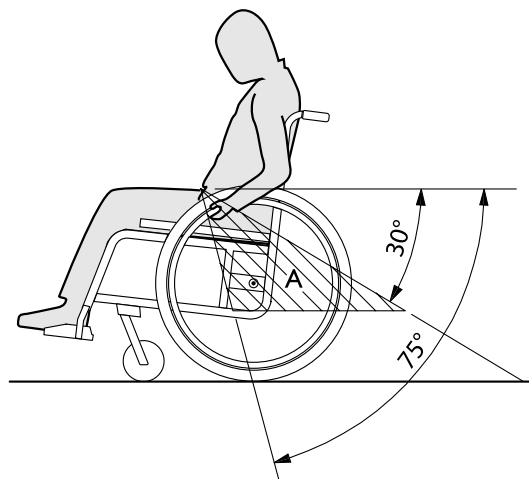

! **NOTICE!**
 – Apply the pelvic belt of the 3-point belt restraint system low across the pelvis so that the angle of the pelvic belt is within the preferred zone (A) of 30° to 75° to the horizontal. A steeper angle is preferred, but never exceeding 75°.

8 Maintenance

8.1 Safety information



WARNING!

Some materials deteriorate naturally over time. This could result in damage to wheelchair components.

- Your wheelchair should be checked by a qualified technician at least once a year or if it has not been used for a long period.



Packaging for return

The wheelchair shall be sent to the authorized provider in an appropriate packaging to avoid damage during the shipment.

8.2 Maintenance Schedule

To ensure safe and reliable operation, carry out the following visual checks and maintenance regularly or have it carried out by another person.

	weekly	monthly	annually
Check the tyre pressure	x		
Check that rear wheels are seated correctly	x		
Check posture belt	x		
Check the folding mechanism		x	
Check the castors and its fixation		x	
Check bolts		x	
Check spokes		x	
Check parking brakes		x	
Have wheelchair checked by a qualified technician			x

General visual check

1. Examine your wheelchair for loose parts, cracks or other defects.
2. If you find anything, stop using your wheelchair immediately and contact an authorized provider.

Check the tyre pressure

1. Check the tyre pressure, see section "Tyres" for more information.
2. Inflate the tyres to the required pressure.
3. Check the tyre tread at the same time.
4. If necessary, change the tyres.

Check that rear wheels are seated correctly

1. Ensure that the axle ball is outside its receiver by visually checking it and pull on the rear wheel to check that the removable axle is seated correctly. The wheel should not come off.
2. If the rear wheels are not engaged properly, remove any dirt or deposits. If the problem persists, have the removable axles re-fitted by a qualified technician.

Check posture belt

1. Check that the posture belt is adjusted correctly.



NOTICE!

- Loose posture belts must be adjusted by an authorized provider.
- Damaged posture belts must be replaced by a qualified technician.

Check the folding mechanism

1. Check that the folding mechanism is easy operating.

Check the castors and its fixation

1. Check that the castors turn freely.
2. Push and pull in the 3 directions (front and rear; left and right; up and down) to observe that there is no free play and movement, also check that there is no visual damage.

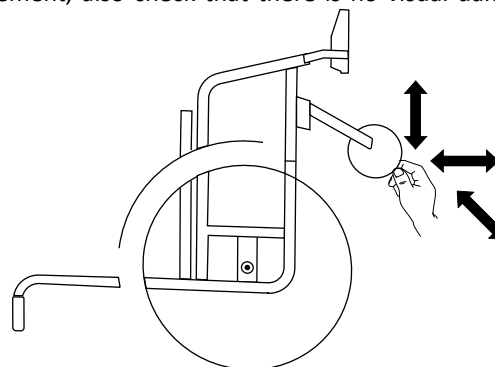

Fig. 8-1

3. Remove any dirt or hair from the castor bearings.
4. Faulty or worn out castors fixation must be replaced by a qualified technician.

Check the bolts

Bolts can work loose through constant use.

1. Check that the bolts are tight securely and without free play (on the footrest, castor, castor housing, seat cover, sides, backrest, frame, seat module).
2. Tighten any loose bolts with the suitable torque.



NOTICE!

- Self-locking screws/nuts or thread-locking adhesive are used for several connections. If these are loosened, they must be replaced by new self-locking screws/nuts or they must be secured using new thread-locking adhesive.
- Self-locking screws/nuts must be replaced by a qualified technician.

Check the spoke tension

The spokes should not be loose or distorted.

1. Loose spokes must be tightened by a qualified technician.
2. Broken spokes must be replaced by a qualified technician.

Check the parking brakes

1. Check that the parking brakes are positioned correctly. The brake is set correctly if the brake shoe depresses the tyre by a few millimeters when the brake is engaged.
2. If you find that the setting is not correct, have the brakes correctly adjusted by a qualified technician.

! **NOTICE!**
The parking brakes must be reset after replacing the rear wheels or changing their position.

Checking after a heavy collision or blow

! **NOTICE!**
The wheelchair can sustain visibly undetectable damage as a result of a heavy collision or hard blow.
– It is essential to have your wheelchair checked by a qualified technician after a heavy collision or hard blow.

Repairing or changing an inner tube

1. Remove the rear wheel and release any air from the inner tube.
2. Lift one tyre wall away from the rim using a bicycle tyre lever. Do not use sharp objects such as a screwdriver which could damage the inner tube.
3. Pull the inner tube out of the tyre.
4. Repair the inner tube using a bicycle repair kit or, if necessary, replace the tube.
5. Inflate the tube slightly until it becomes round.

6. Insert the valve into the valve hole on the rim and place the tube inside the tyre (the tube should lie right round the tyre with no creases).
7. Lift the tyre wall over the edge of the rim. Start close to the valve and use a bicycle tyre lever. When doing this, check all the way round to ensure that the inner tube is not trapped between the tyre and the rim.
8. Inflate the tyre to the maximum operating pressure. Check that no air is escaping from the tyre.

Spare parts

 All spare parts may be obtained from an Invacare authorized provider.

8.3 Tightening torques

! **NOTICE!**
Do not overtighten the mounting hardware as this might cause damage to the product.

If not otherwise stated in the specific instructions the following guidelines apply:

Thread	Tightening torque in Nm \pm 10%
M4	3 Nm
M5	6 Nm
M6	10 Nm
M8	25 Nm
M10	49 Nm
M12	80 Nm
M14	120 Nm
M16	180 Nm

8.4 Cleaning and Disinfection

8.4.1 General Safety Information



CAUTION!

Risk of Contamination

- Take precautions for yourself and use appropriate protective equipment.



NOTICE!

Wrong fluids or methods can harm or damage the product.

- All cleaning agents and disinfectants used must be effective, compatible with one another and must protect the materials they are used to clean.
- Never use corrosive fluids (alkalines, acid etc.) or abrasive cleaning agents. We recommend an ordinary household cleaning agent such as dishwashing liquid, if not specified otherwise in the cleaning instructions.
- Never use a solvent (cellulose thinner, acetone etc.) that changes the structure of the plastic or dissolves the attached labels.
- Always make sure that the product is completely dried before taking it into use again.



For cleaning and disinfection in clinical or long-term care environments, follow your in-house procedures.

8.4.2 Cleaning Intervals



NOTICE!

Regular cleaning and disinfection enhance smooth operation, increases the service life and prevents contamination.

Clean and disinfect the product:

- regularly while in use,
- before and after any service procedure,
- when it has been in contact with any body fluids,
- before using it for a new user.

8.4.3 Cleaning



NOTICE!

- The product does not tolerate cleaning in automatic washing plants, with high-pressure cleaning equipment or steam.



NOTICE!

Dirt, sand and seawater can damage the bearings and steel parts can rust if the surface is damaged.

- Only expose the wheelchair to sand and seawater for short periods and clean it after every trip to the beach.
- If the wheelchair is dirty, wipe off the dirt as soon as possible with a damp cloth and dry it carefully.

1. Remove any installed optional equipment (only optional equipment which does not require tools).
2. Wipe down the individual parts using a cloth or soft brush, ordinary household cleaning agents (pH = 6 - 8) and warm water.
3. Rinse the parts with warm water.
4. Thoroughly dry the parts with a dry cloth.



Car polish and soft wax can be used on painted metal surfaces to remove abrasions and restore gloss.

Cleaning upholstery

For cleaning upholstery refer to the instructions on the labels of the seat, cushion and backrest cover.



If possible, always overlap hook and loop strips (the self-gripping parts) when washing, to minimize lint and thread build-up on hook strips and prevent damage to upholstery fabric by these.

8.4.4 Disinfection

The wheelchair may be disinfected by spraying or wiping with tested, approved disinfectants.



Spray a soft cleaning and disinfecting product (bactericidal and fungicide meeting the EN1040 / EN1276 / EN1650 standards) and follow the instructions given by the manufacturer.

1. Wipe down all generally accessible surfaces with a soft cloth and ordinary household disinfectant.
2. Allow the product to air-dry.

9 Troubleshooting

9.1 Safety information

Faults may arise as a result of daily use, adjustments or changing demands on the wheelchair. The table below shows how to identify and repair faults.

Some of the actions listed must be carried out by a qualified technician. These are indicated. We recommend that *all* adjustments are carried out by a qualified technician.

**CAUTION!**

– If you notice a fault with your wheelchair, e.g. a significant change in handling, stop using your wheelchair immediately and contact your provider.

9.2 Identifying and Repairing Faults

Fault	Possible cause	Action
The wheelchair does not travel in a straight line	Incorrect tyre pressure on one rear wheel	Correct tyre pressure, → <i>11.2 Tyres, page 48</i>
	One or more spokes broken	Replace faulty spoke(s), → qualified technician
	Spokes tightened unevenly	Tighten loose spokes, → qualified technician
	Castor bearings are dirty or damaged	Clean the bearings or replace the castor, → qualified technician
The wheelchair tips backwards too easily	Rear wheels are mounted too far forwards	Mount the rear wheels further back, → qualified technician
	Back angle too large	Reduce the backrest angle, → qualified technician
	Seat angle too large	Mount the castor upper on the front fork, → qualified technician Select a smaller front fork, → qualified technician
The brakes are gripping poorly or asymmetrically	Incorrect tyre pressure in one or both rear tyres	Correct tyre pressure, → <i>11.2 Tyres, page 48</i>
	Brake setting incorrect	Correct the brake setting, → qualified technician
Rolling resistance is very high	Tyre pressure in rear tyres is too low	Correct tyre pressure, → <i>11.2 Tyres, page 48</i>
	Rear wheels not parallel	Ensure the rear wheels are parallel, → qualified technician
The castors wobble when moving fast	Too little tension in castor bearing block	Tighten the nut on the bearing block axle slightly, → qualified technician
	Castor has worn smooth	Change castor, → qualified technician
The castor is stiff or stuck	Bearings are dirty or faulty	Clean the bearings or replace the castor, → qualified technician
The wheelchair is very difficult to unfold	Backrest cover is too tight	Loosen the hook and loop strips of the backrest cover a little, → <i>3.7 Adjusting the Shape — Tension Adjustable Backrest, page 10</i>

10 After Use

10.1 Storage

- !** **NOTICE!**
Risk of damage to the product
- Do not store the product near heat sources.
 - Never store other items on top of the wheelchair.
 - Store the wheelchair indoors in a dry environment.
 - Refer to temperature limitation in chapter *11 Technical Data, page 47*.

After long-term storage (more than four months) the wheelchair must be inspected in accordance to chapter *8 Maintenance, page 41*.

10.2 Reconditioning

This product is suitable for reuse. To recondition the product for a new user, carry out the following actions:

- Inspection
- Cleaning and disinfection
- Adaptation to the new user

For detailed information, see *8 Maintenance, page 41* and the service manual for this product.

Make sure that the user manual is handed over with the product.

If any damage or malfunction is detected, do not reuse the product.

10.3 Disposal

Be environmentally responsible and recycle this product through your recycling facility at its end of life.

Disassemble the product and its components, so the different materials can be separated and recycled individually.

The disposal and recycling of used products and packaging must comply with the laws and regulations for waste handling in each country. Contact your local waste management company for information.

11 Technical Data

11.1 Dimensions and weights

All dimension and weight specifications refer to a wide range of the wheelchair in a standard configuration. Dimension and weight (based on ISO 7176-1/5/7) may alter according to different configurations.

- !** **NOTICE!**
- In some configurations, the overall dimensions of the wheelchair when it is ready for use exceeds the authorised limits and the access to emergency escape routes is not possible.
 - In some configurations, the wheelchair exceeds the size recommended for travelling by train in the EU.

	FOCUS	FOCUS 150
Seat width	380–505 mm	530–555 mm
Seat depth	Low chassis: 375–450 mm High chassis: 425–500 mm Transit: 425–500 mm	425–500 mm
Seat height	Low chassis: 365–490 mm High chassis: 415–540 mm Transit: 430–465 mm	440–540 mm
Backrest height	380–780 mm	380–780 mm
Armrest height	190–290 mm Transit: 210–385 mm	190–290 mm
Leg rest length (footrest to seat distance)	355–465 mm in increments of 10 mm	355–465 mm in increments of 10 mm
Tilt adjustment (seat plane angle)	0° – 6°	0° – 6°
Backrest adjustment	– 6°-13° Recline backrest: 0° – 30°	– 6°-13°
Overall width	SW + 220 mm	SW + 220 mm
Total height	745–1320 mm	745–1320 mm
Total length (overall length with legrests)	900–1195 mm Transit: 1080–1180 mm	900–1195 mm
Folded width	320 mm Transit: 310 mm	320 mm
Folded length	595–890 mm	595–890
Folded height	893–930	893–930
Max. user weight	135 kg	150 kg
Transport weight	10 kg	10 kg
Total weight	16,2 kg	16,2 kg
Static stability uphill	9° -14°	9° -14°
Static stability downhill	12° -20°	12° -20°
Static stability sideways	19°	19°
Max. slope with parking brake	7°	7°
Leg to surface angle	96° -211°	96° -211°
Front location of armrest structure	320–505 mm	320–505 mm
Handrim diameter	450–540 mm	450–540 mm

Horizontal location of axle	25–85 mm	25–85 mm
Minimum turning radius	785 mm	785 mm

	515 mm (20")	560 mm (22")	600 mm (24")	405 mm (16")
Width of the wheels	35 mm (1 3/8")	25 mm (1") - 35 mm (1 3/8")	25 mm (1") - 35 mm (1 3/8")	45 mm (1 3/4")
Wheel inclination	0° +/- 1° (Wheelchair without load)			

11.1.1 Maximum Weight of Removable Parts

Maximum weight of removable parts	
Part:	Maximum weight:
Leg rest angle adjustable with calf pad and footrest	3,2 kg
Armrest	2,0 kg
Rear wheel 600 mm (24") solid with handrim and spoke guard	2,5 kg
Headrest / Neckrest / Cheek support	1,4 kg
Trunk support	0,8 kg
Backrest cushion	2,0 kg
Seat cushion	1,9 kg
Table tray	3,9 kg



11.2 Tyres

The ideal pressure depends on the tyre type:

The table below is an indication. In case the tyre differs from the list below, check the side of the tyre, the maximum pressure is listed there.

Tyre	Max. pressure		
	bar	kPa	psi
Pneumatic profiled tyre: 515 mm (20"); 560 mm (22"); 610 mm (24")	4.5	450	65
Pneumatic low profile tyre: 515 mm (20"); 560 mm (22"); 610 mm (24")	7.5	750	110
Solid tyre: 560 mm (22"); 610 mm (24")	-	-	-

Tyre	Max. pressure		
	bar	kPa	psi
Solid tyre: 125 mm (5"); 140 mm (5" 1/2); 150 mm (6"); 200 mm (8")	-	-	-
Pneumatic tyre: 150 mm (6"); 180 mm (7"); 200 mm (8")	2.5	250	36

-  The compatibility of the tyres listed above depends on the configuration and/or model of your wheelchair.
-  The size of the tyre is mentioned on the sidewall of the tyre. The change of appropriate tyres must be carried out by a qualified technician.
-  In case of a tyre puncture consult a suitable workshop (e.g. bike repair shop, bicycle dealer ...) to have the tube replaced by a skilled person.



CAUTION!

- The tyres pressure have to be equal in both wheels to avoid a less driving comfort, to keep the brakes efficiency and an easy propelling of the wheelchair.

11.3 Material

Chassis, backrest tubes	Aluminium
Plastic parts like brake handles, clothes guards, foot plates, armpads and parts of most options	Thermoplastic (e.g. PA, PP, ABS and PUR) according to marking on the parts
Upholstery (seat and backrest)	Foam (PUR), Fabric Nylon and Polyester, Jemima and Plush fabric and Multi stretch polyurethane (PU) coated fabric

Table tray	Thermoplastic (ABS) according to marking on the part
Screws, washers and nuts	Steel

 All materials used are protected against corrosion. We use only REACH compliant materials and components.

 Theft and metal detection systems: in seldom cases the materials used in the wheelchair may activate theft and metal detection systems.

11.4 Environmental conditions



	Storage and transportation	Operation
Temperature	-20 °C to 40 °C	-5 °C to 40 °C

Relative humidity	20 % to 90 % at 30 °C, not condensing
Atmospheric pressure	800 hPa to 1060 hPa

 Be aware that when a wheelchair has been stored under low temperatures, it must be adjusted to chapter 8 Maintenance, page 41 before use.

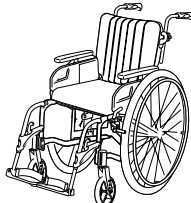
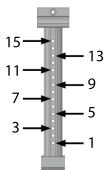
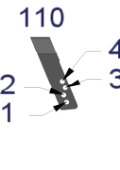

11.5 Seat height tables

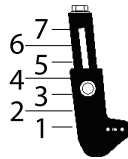
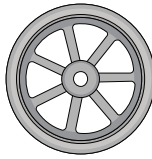
11.5.1 Rea Focus High — 515 x 35 mm (20 x 1 3/8")

						
415	3°	9	4	N/A	7	125
440	3°	7	2	N/A	5	125
440	3°	7	3	N/A	N/A	140
440	3°	7	3	N/A	6	150
465	3°	5	N/A	3	3	125
465	3°	5	1	4	N/A	140
465	3°	5	1	4	4	150
465	3°	5	2	N/A	N/A	180
490	3°	3	N/A	1	1	125
490	3°	3	N/A	2	N/A	140
490	3°	3	N/A	2	2	150
490	3°	3	N/A	3	N/A	180
490	3°	3	1	4	4	200

N/A = Not applicable, * = Not possible in combination with 90° leg rests

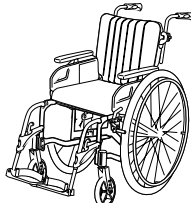
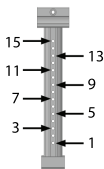
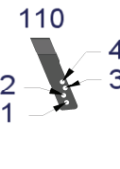
11.5.2 Rea Focus High — 560 x 35 mm (22 x 1 3/8")

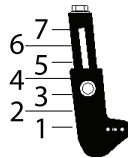
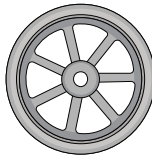
						
415	3°	11	4	N/A	7	125
440	3°	9	2	N/A	5	125

440	3°	9	3	N/A	N/A	140
440	3°	9	3	N/A	6	150
465	3°	7	N/A	3	3	125
465	3°	7	1	4	N/A	140
465	3°	7	1	4	4	150
465	3°	7	2	N/A	N/A	180
490	3°	5	N/A	1	1	125
490	3°	5	N/A	2	N/A	140
490	3°	5	N/A	2	2	150
490	3°	5	N/A	3	N/A	180
490 *	3°	5	1	4	4	200
515	3°	3	N/A	1	N/A	140
515	3°	3	N/A	1	1	150
515	3°	3	N/A	2	N/A	180
515 *	3°	3	N/A	3	3	200
540 *	3°	1	N/A	1	1	200

N/A = Not applicable, * = Not possible in combination with 90° leg rests

11.5.3 Rea Focus High — 560 x 25 mm (22 x 1")

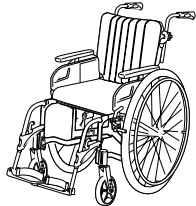
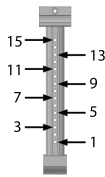
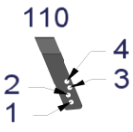
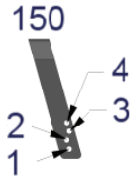
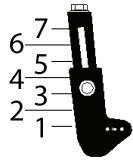
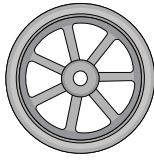
						
415	3°	10	4	N/A	7	125
440	3°	8	2	N/A	5	125
440	3°	8	3	N/A	N/A	140
440	3°	8	3	N/A	6	150
465	3°	6	N/A	3	3	125
465	3°	6	1	4	N/A	140
465	3°	6	1	4	4	150
465	3°	6	2	N/A	N/A	180
490	3°	4	N/A	1	1	125
490	3°	4	N/A	2	N/A	140
490	3°	4	N/A	2	2	150
490	3°	4	N/A	3	N/A	180
490 *	3°	4	1	4	4	200
515	3°	2	N/A	1	N/A	140
515	3°	2	N/A	1	1	150
515	3°	2	N/A	2	N/A	180
515 *	3°	2	N/A	3	3	200
540 *	3°	N/A	N/A	N/A	N/A	200

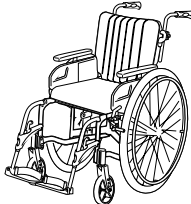
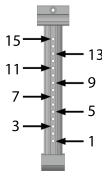
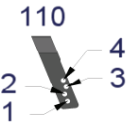
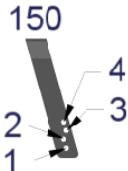
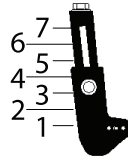
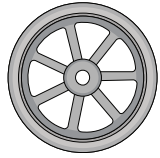

N/A = Not applicable, * = Not possible in combination with 90° leg rests

11.5.4 Rea Focus High — 610 x 35 mm (24 x 1 3/8")

						
415	3°	13	4	N/A	7	125
440	3°	11	2	N/A	5	125
440	3°	11	3	N/A	N/A	140
440	3°	11	3	N/A	6	150
465	3°	8	N/A	3	3	125
465	3°	8	1	4	N/A	140
465	3°	8	1	4	4	150
465	3°	8	2	N/A	N/A	180
490	3°	6	N/A	1	1	125
490	3°	6	N/A	2	N/A	140
490	3°	6	N/A	2	2	150
490	3°	6	N/A	3	N/A	180
490 *	3°	6	1	4	4	200
515	3°	5	N/A	1	N/A	140
515	3°	5	N/A	1	1	150
515	3°	5	N/A	2	N/A	180
515 *	3°	5	N/A	3	3	200
540 *	3°	3	N/A	1	1	200

N/A = Not applicable, * = Not possible in combination with 90° leg rests

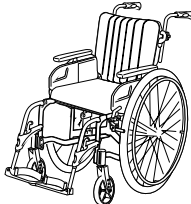
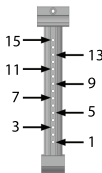
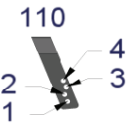
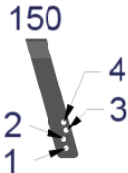
11.5.5 Rea Focus High — 610 x 25 mm (24 x 1")

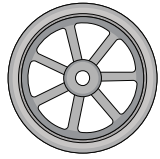
						
415	3°	12	4	N/A	7	125
440	3°	10	2	N/A	5	125
440	3°	10	3	N/A	N/A	140
440	3°	10	3	N/A	6	150
465	3°	8	N/A	3	3	125
465	3°	8	1	4	N/A	140
465	3°	8	1	4	4	150
465	3°	8	2	N/A	N/A	180
490	3°	5	N/A	1	1	125
490	3°	5	N/A	2	N/A	140
490	3°	5	N/A	2	2	150

490	3°	5	N/A	3	N/A	180
490 *	3°	5	1	4	4	200
515	3°	4	N/A	1	N/A	140
515	3°	4	N/A	1	1	150
515	3°	4	N/A	2	N/A	180
515 *	3°	4	N/A	3	3	200
540 *	3°	2	N/A	1	1	200

N/A = Not applicable, * = Not possible in combination with 90° leg rests

11.5.6 Rea Focus Low — 515 x 35 mm (20 x 1 3/8")

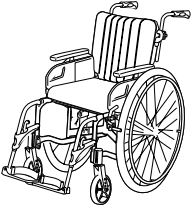
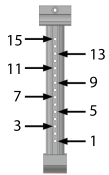
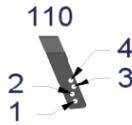
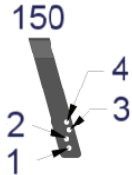
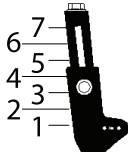
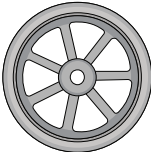
						
365	3°	9	4	N/A	7	125
390	3°	7	2	N/A	5	125
390	3°	7	3	N/A	N/A	140
390	3°	7	3	N/A	6	150
415	3°	5	N/A	3	3	125
415	3°	5	1	4	N/A	140
415	3°	5	1	4	4	150
440	3°	3	N/A	1	1	125
440	3°	3	N/A	2	N/A	140
440	3°	3	N/A	2	2	150
440	3°	3	N/A	3	N/A	180

N/A = Not applicable, * = Not possible in combination with 90° leg rests

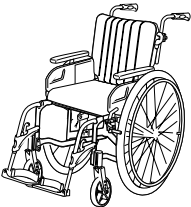
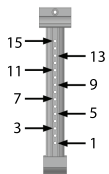
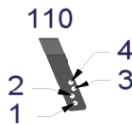
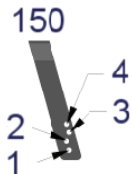
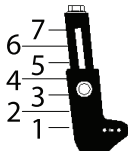
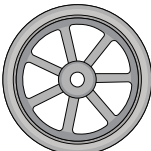

11.5.7 Rea Focus Low — 560 x 35 mm (22 x 1 3/8")

						
365	3°	11	4	N/A	7	125
390	3°	9	2	N/A	5	125
390	3°	9	3	N/A	N/A	140
390	3°	9	3	N/A	6	150
415	3°	7	N/A	3	3	125
415	3°	7	1	4	N/A	140
415	3°	7	1	4	4	150
415	3°	7	2	N/A	N/A	180
440	3°	5	N/A	1	1	125

440	3°	5	N/A	2	N/A	140
440	3°	5	N/A	2	2	150
440	3°	5	N/A	3	N/A	180
440 *	3°	5	1	4	4	200
465	3°	3	N/A	1	N/A	140
465	3°	3	N/A	1	1	150
465	3°	3	N/A	2	N/A	180
465 *	3°	3	N/A	3	3	200
490 *	3°	1	N/A	1	1	200

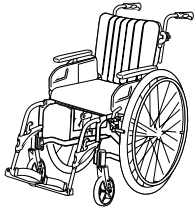
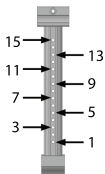
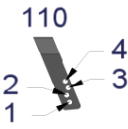
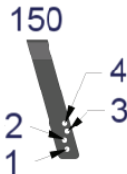

N/A = Not applicable, * = Not possible in combination with 90° leg rests

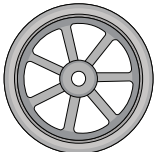
11.5.8 Rea Focus Low — 560 x 25 mm (22 x 1")

						
365	3°	10	4	N/A	7	125
390	3°	8	2	N/A	5	125
390	3°	8	3	N/A	N/A	140
390	3°	8	3	N/A	6	150
415	3°	6	N/A	3	3	125
415	3°	6	1	4	N/A	140
415	3°	6	1	4	4	150
415	3°	6	2	N/A	N/A	180
440	3°	4	N/A	1	1	125
440	3°	4	N/A	2	N/A	140
440	3°	4	N/A	2	2	150
440	3°	4	N/A	3	N/A	180
440 *	3°	4	1	4	4	200
465	3°	2	N/A	1	N/A	140
465	3°	2	N/A	1	1	150
465	3°	2	N/A	2	N/A	180
465 *	3°	2	N/A	3	3	200
490 *	3°	N/A	N/A	N/A	N/A	200

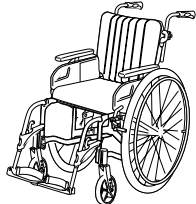
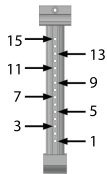
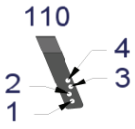

N/A = Not applicable, * = Not possible in combination with 90° leg rests

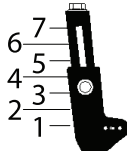
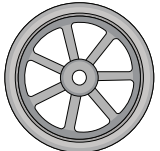
11.5.9 Rea Focus Low — 610 x 35 mm (24 x 1 3/8")

						
390	3°	10	2	N/A	5	125
390	3°	10	3	N/A	N/A	140
390	3°	10	3	N/A	6	150
415	3°	8	N/A	3	3	125
415	3°	8	1	4	N/A	140
415	3°	8	1	4	4	150
415	3°	8	2	N/A	N/A	180
440	3°	6	N/A	1	1	125
440	3°	6	N/A	2	N/A	140
440	3°	6	N/A	2	2	150
440	3°	6	N/A	3	N/A	180
440 *	3°	6	1	4	4	200
465	3°	5	N/A	1	N/A	140
465	3°	5	N/A	1	1	150
465	3°	5	N/A	2	N/A	180
465 *	3°	5	N/A	3	3	200
490 *	3°	3	N/A	1	1	200

N/A = Not applicable, * = Not possible in combination with 90° leg rests

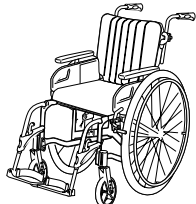
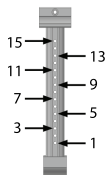
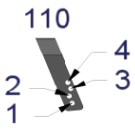
11.5.10 Rea Focus Low — 610 x 25 mm (24 x 1")

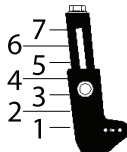
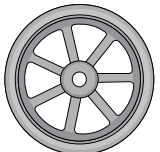
						
390	3°	9	2	N/A	5	125
390	3°	9	3	N/A	N/A	140
390	3°	9	3	N/A	6	150
415	3°	7	N/A	3	3	125
415	3°	7	1	4	N/A	140
415	3°	7	1	4	4	150
415	3°	7	2	N/A	N/A	180
440	3°	5	N/A	1	1	125
440	3°	6	N/A	2	N/A	140
440	3°	5	N/A	2	2	150
440	3°	5	N/A	3	N/A	180
440 *	3°	5	1	4	4	200

465	3°	4	N/A	1	N/A	140
465	3°	4	N/A	1	1	150
465	3°	4	N/A	2	N/A	180
465 *	3°	4	N/A	3	3	200
490 *	3°	2	N/A	1	1	200

N/A = Not applicable, * = Not possible in combination with 90° leg rests



United Kingdom & Ireland:

Invacare Limited
Pencoed Technology Park,
Pencoed
Bridgend CF35 5AQ
Tel: (44) (0) 1656 776 200
uk@invacare.com
www.invacare.co.uk



Manufacturer:

Invacare Rea AB
Växjövägen 303
SE-343 71 Diö
Sweden

1431580-D 2023-05-21



Making Life's Experiences Possible®



Yes, you can.